

*Maakua Well Project*

BENJAMIN J. CAYETANO  
GOVERNOR OF HAWAII



STATE OF HAWAII  
DEPARTMENT OF LAND AND NATURAL RESOURCES  
LAND DIVISION  
P.O. BOX 621  
HONOLULU, HAWAII 96809

RECEIVED

AQUACULTURE DEVELOPMENT PROGRAM  
AQUATIC RESOURCES  
BOATING AND OCEAN RECREATION  
CONSERVATION AND RESOURCES ENFORCEMENT  
CONVEYANCES  
FORESTRY AND WILDLIFE  
HISTORIC PRESERVATION  
LAND DIVISION  
STATE PARKS  
WATER RESOURCE MANAGEMENT

JUL -2 11:10

OFFICE OF ENVIRONMENTAL QUALITY CONTROL

Ref:PB:SL

FILE NO.: OA-2636A

Mr. Gary Gill, Director  
Office of Environmental Quality Control  
220 South King Street, the Floor  
Honolulu, Hawaii 96813

JUN 26 1996

Dear Mr. Gill:

Subject: Negative Declaration for an Amendment to CDUP OA-2636A to Include the Construction of a 10,000 Gallon Reservoir at Hauula, Oahu TMK: 5-4-05: 001

The Department of Land and Natural Resources has reviewed the comments received during the 30-day public comment period which began on March 8, 1995. The agency has determined that this project will not have significant environmental effect and has issued a negative declaration. Please publish this notice in the OEQC Bulletin as soon as possible.

We have enclosed a completed OEQC Bulletin Publication Form and four copies of the final EA. Please contact Sam Lemmo at 587-0386 if you have any questions.

Aloha,

*Dean Y. Uchida*  
Dean Y. Uchida, Administrator  
Land Division

Attachment

1996-07-23-DA-FAA-Maakua Well Project

JUL 23 1996

FILE COPY

**Maakua Well Project**  
Hauula Town, Koolauloa District, Oahu  
TMK: 5-4-5:por. 1

**Final  
Amended  
Environmental Assessment**



Honolulu Board of Water Supply  
630 South Beretania Street  
Honolulu, Hawaii 96843

May 1996

# Maakua Well Project

Hauula Town, Koolauloa District, Oahu  
TMK: 5-4-5:por. 1

## Final Amended Environmental Assessment

Prepared by  
Ogden Environmental and Energy Services Co., Inc.  
680 Iwilei Road, Suite 660  
Honolulu, Hawaii 96817

February 1993

Amended by  
Honolulu Board of Water Supply  
630 South Beretania Street  
Honolulu, Hawaii 96843

May 1996

## TABLE OF CONTENTS

<u>SECTION</u>	<u>TITLE</u>	<u>PAGE</u>
S	SUMMARY	S-1
S.1	Project Objectives	S-1
S.2	Project and Site Description	S-1
S.3	Project Features	S-1
S.4	Potential Impacts and Mitigation Measures	S-2
S.5	Applicant/Proposing Agency	S-2
S.6	Approving Agency	S-2
S.7	Agencies Consulted	S-2
S.8	Required Permits and Approvals	S-3
1	INTRODUCTION	1-1
2	PROPOSED ACTION	2-1
2.1	Purpose	2-1
2.2	Project Location	2-1
2.3	Project Description	2-1
2.3.1	Project Features	2-4
2.3.2	Project Construction	2-7
2.4	Project Cost	2-10
3	ENVIRONMENTAL SETTING	3-1
3.1	Climate	3-1
3.2	Geology and Topography	3-1
3.3	Soils	3-2
3.4	Hydrology	3-3
3.4.1	Surface Water	3-3
3.4.2	Ground Water	3-3
3.5	Biological Resources	3-3
3.5.1	Vegetation	3-3
3.5.2	Fauna	3-4
3.5.3	Wetlands	3-5
3.6	Air Quality	3-5

**TABLE OF CONTENTS (Continued)**

<b><u>SECTION</u></b>	<b><u>TITLE</u></b>	<b><u>PAGE</u></b>
3.7	Natural Hazards	3-5
3.8	Cultural Resources	3-6
3.9	Socio-Economics	3-6
3.10	Roads and Transportation	3-6
3.11	Visual and Recreational Resources	3-7
4	<b>POTENTIAL IMPACTS AND MITIGATION MEASURES</b>	4-1
4.1	Geology and Topography	4-1
4.2	Soils	4-1
4.3	Hydrology	4-2
4.3.1	Surface Water	4-2
4.3.2	Ground Water	4-3
4.4	Biological Resources	4-4
4.4.1	Vegetation	4-4
4.4.2	Fauna	4-4
4.4.3	Wetlands	4-5
4.5	Air Quality	4-5
4.6	Natural Hazards	4-6
4.7	Cultural Resources	4-6
4.8	Socio-Economics	4-7
4.9	Land Use and Zoning	4-7
4.10	Roads and Transportation	4-7
4.11	Visual and Recreational Resources	4-8
5	<b>POSSIBLE ALTERNATIVES</b>	5-1
5.1	No Action	5-1
5.2	Delayed Action	5-1
5.3	Alternate Sites	5-1
5.4	Alternate Sources	5-3
6	<b>DETERMINATION</b>	6-1

**TABLE OF CONTENTS (Continued)**

<b><u>SECTION</u></b>	<b><u>TITLE</u></b>	<b><u>PAGE</u></b>
7	AGENCIES CONSULTED	7-1
8	REFERENCES	8-1

**LIST OF FIGURES**

<b><u>NUMBER</u></b>	<b><u>TITLE</u></b>	<b><u>PAGE</u></b>
2-1	Maakua Well Site Location	2-2
2-2	Board of Water Supply Hauula 180 System	2-3
2-3	Well Site Plan	2-5
2-4	Reservoir Site Plan	2-6
5-1	Well Site Alternatives	5-2

**LIST OF TABLES**

<b><u>NUMBER</u></b>	<b><u>TITLE</u></b>	<b><u>PAGE</u></b>
2-1	Assumed Grading Requirements	2-9

**LIST OF APPENDICES**

<b><u>NUMBER</u></b>	<b><u>TITLE</u></b>
I	Botanical Survey
II	Archaeological Site Evaluation and Impact Assessment for the Proposed Access Road and Water Well Location, Ma'akua, Hau'ula Ahupua'a Ko'olauloa District, O'ahu
III	Comments and Responses to Public Review of Draft EA
IV	Comments and Responses to Public Review of Draft Amended EA

## SUMMARY

### S.1 PROJECT OBJECTIVES

The proposed Maakua Well is part of a major water development project to integrate new ground water sources in Windward Oahu in order to meet the growing demand for potable water within the City and County of Honolulu. The well is expected to contribute up to 1.0 mgd of the 45 mgd potential yield from overall Windward water system improvements by the year 2000.

### S.2 PROJECT AND SITE DESCRIPTION

The project site is beyond the end of Maakua Road, about 0.6 miles inland from Kamehameha Highway in Hauula Town, Koolauloa District, Oahu. The proposed pumping station is located about a quarter of a mile along the Maakua Gulch Trail, 160 feet above mean sea level. The property at the site is designated as a State Conservation Land Use District, Resource (R) subzone within a 152-acre parcel owned by the State of Hawaii (Tax Map Key 5-4-5:01).

The proposed project involves construction of the well site (including the well pad, pump control building, and retaining wall) and 10,000 gallon overflow reservoir, pipeline installation, stream crossing, and reconstruction of the existing access road. Water pumped from the well will primarily serve the Hauula area. A booster station located in Hauula will pump the well water toward Kahana; excess water will be diverted to the Kailua/Kaneohe area.

### S.3 PROJECT FEATURES

The following table describes the features of the proposed well site:

<u>ITEM</u>	<u>MAAKUA WELL SITE</u>
Tax Map Key (TMK)	5-4-5:01
Total Parcel Area	152 Acres
Flood Insurance Rate Map (FIRM)	Flood Zone D (area of undetermined but possible flood hazard)
State Land Use District	Conservation, Resource (R) subzone
State Water Management Area	Windward
City & County of Honolulu Development Plan Public Facilities Map	Site Determined

City & County of Honolulu Zoning	Preservation (P-1)
Estimated Yield of Production Well	1.0 mgd
Land Owner	State of Hawaii
Nearest Access	Maakua Gulch Trail, inland of Maakua Road

**S.4 POTENTIAL IMPACTS AND MITIGATION MEASURES**

The primary potential impacts associated with the project will be temporary, lasting only until project completion (about 12 months); these include minor traffic, noise, and air quality disturbances to local residents and recreational hikers. Standard measures will be implemented to minimize or alleviate these effects.

No significant long-term impacts are anticipated. Potential impacts to cultural resource sites in the vicinity will be prevented according to a site-specific mitigation plan. The project is expected to have little impact on local ground water and surface water resources. Application of current interim instream flow standards will ensure that ground water pumping does not result in significant dewatering within the Maakua Stream drainage basin.

**S.5 APPLICANT/PROPOSING AGENCY**

Board of Water Supply, City and County of Honolulu

**S.6 APPROVING AGENCY**

Department of Land and Natural Resources, State of Hawaii

**S.7 AGENCIES CONSULTED**

Safe Drinking Water Branch, Department of Health  
 Commission on Water Resource Management, Department of Land and Natural Resources  
 Division of Water and Land Development, Department of Land and Natural Resources  
 Division of Aquatic Resources, Department of Land and Natural Resources  
 Division of Forestry and Wildlife, Department of Land and Natural Resources  
 Division of Land Management, Department of Land and Natural Resources  
 State Historic Preservation Division, Department of Land and Natural Resources



Office of Conservation and Environmental Affairs, Department of Land and Natural Resources  
Department of Transportation  
Office of Environmental Quality Control  
Office of Hawaiian Affairs  
University of Hawaii at Manoa Environmental Center  
Department of Public Works, City and County of Honolulu  
Planning Department, City and County of Honolulu  
Department of Land Utilization, City and County of Honolulu

#### **S.8 REQUIRED PERMITS AND APPROVALS**

The following permits will be required from the State Department of Land and Natural Resources:

Conservation District Use Permit  
Permit for Use of State Lands  
Stream Channel Alteration Permit  
Water Use Permit  
Well Modification Permit  
Well Construction Permit  
Pump Installation Permit

The following permits and approvals will be required from the State Department of Health:

National Pollutant Discharge Elimination System (NPDES) Permit  
Section 401 Water Quality Certification  
Source Approval by the Director of Health, in compliance with Hawaii Administrative  
Rules, Title 11, Chapter 20, "Potable Water Systems"

A Stream Channel Alteration Permit will be required from the U.S. Department of the Army and a Coastal Zone Management Consistency Determination will be required from the Office of State Planning. A Construction Dewatering permit from the City and County of Honolulu Department of Public Works will be required if existing drainage facilities are utilized for effluent disposal.

## SECTION 1 INTRODUCTION

The proposed project is a component of the Board of Water Supply's development plan for Windward Oahu Regional Water System Improvements. The programmatic Final Environmental Impact Statement (FEIS) for these improvements was submitted in August 1988 by the Board of Water Supply (BWS) and subsequently accepted. In conjunction with the accepted FEIS, the BWS intends to prepare environmental assessments (EAs) as each water development project is programmed for possible construction, to address plans, implementation, and potential impacts and mitigation measures on an individual project basis.

In 1989, an EA was prepared for construction of an exploratory well and access road at Maakua Gulch, Hauula Town, Koolauloa District, island of Oahu (Belt Collins 1989). The EA received a Negative Declaration. Viability of a permanent well at Maakua was subsequently confirmed through pumping tests by the BWS.

In 1993, an EA was prepared for construction of a permanent water well at the site of the Maakua exploratory well (Ogden Environmental and Energy Services 1993). This EA also received a Negative Declaration. Subsequent to this determination, the need for an overflow reservoir at the Maakua well station site was identified. The 10,000 gallon reinforced concrete reservoir will serve to stabilize water pressure in the existing water system by controlling pressure surges which occur when pumps are turned on and off and to keep transmission mains full of water when pumps are turned off.

This amended EA addresses the development of a permanent pumping station and access road located at the Maakua Gulch location, including the construction of the overflow reservoir. This document has been prepared in accordance with Chapter 343, Hawaii Revised Statutes (HRS) and with Chapter 200 of Title 11, Department of Health (DOH) Administrative Rules. The Board of Water Supply, City and County of Honolulu, is the proposing agency. The Department of Land and Natural Resources, State of Hawaii, is the approving agency.

## **SECTION 2 PROPOSED ACTION**

### **2.1 PURPOSE**

To meet Oahu's growing demand for water, the BWS is focusing on development of the island's Windward water resources. The proposed Maakua Well Project is a part of the major water development project which will integrate new ground water sources within Windward Oahu into the existing water distribution system and provide potable water for local use within the City and County of Honolulu. The proposed well is expected to contribute up to 1.0 mgd of the 45 mgd potential yield proposed for Windward water system improvements (BWS 1988) by the year 2000. The yield of the proposed Maakua Well is committed to the State of Hawaii to provide water for schools, parks and other State projects.

### **2.2 PROJECT LOCATION**

The proposed pumping station is located beyond the end of Maakua Road, an extension of Hauula Homestead Road, about 0.6 miles inland from Kamehameha Highway in Hauula, Koolauloa District, Oahu (Figure 2-1). The project site is about a quarter of a mile along the Maakua Gulch trail, at 21°36'18" N latitude and 157°55'18" W longitude, 160 feet above mean sea level. The property at the site is designated a State Conservation Land Use District, Resource (R) subzone within a 152-acre parcel owned by the State of Hawaii (Tax Map Key 5-4-5:01). On the City and County of Honolulu Development Plan Land Use Map, the proposed site is zoned as Preservation (P-1).

### **2.2 PROJECT DESCRIPTION**

The proposed project involves construction of the well site (including the well pump and pad, pump control building, and retaining wall) and 10,000 gallon overflow reservoir, pipeline installation, stream crossing, and reconstruction of the existing access road. Water will be pumped from the well into the Hauula water system. A booster station proposed for the Kaluanui area will pump any excess well water toward the existing Kahana 315' reservoir for use within the Kailua/Kaneohe area and in East Honolulu.

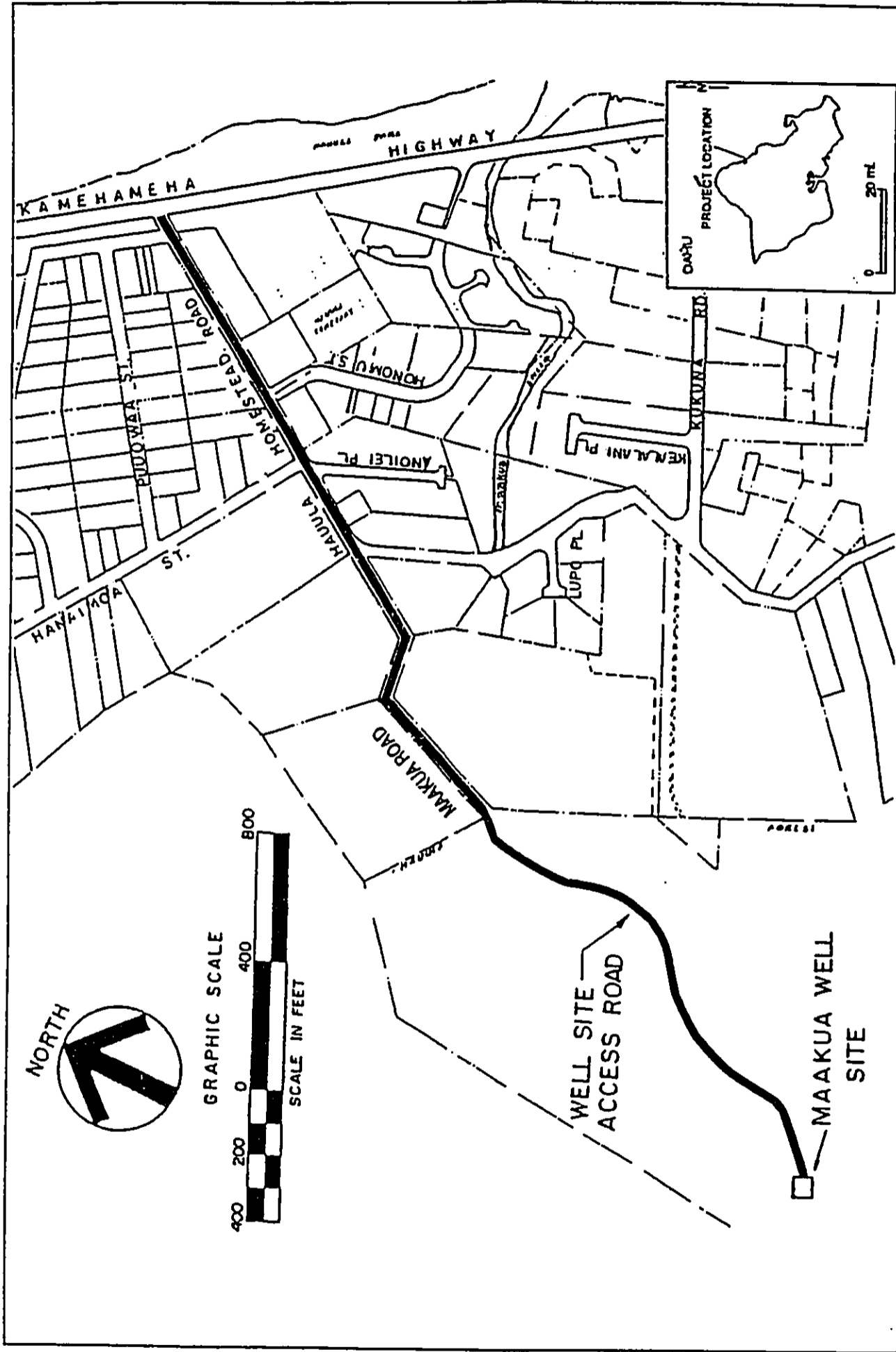

FIGURE

2-1

MAAKUA WELL SITE LOCATION

**OGDEN**

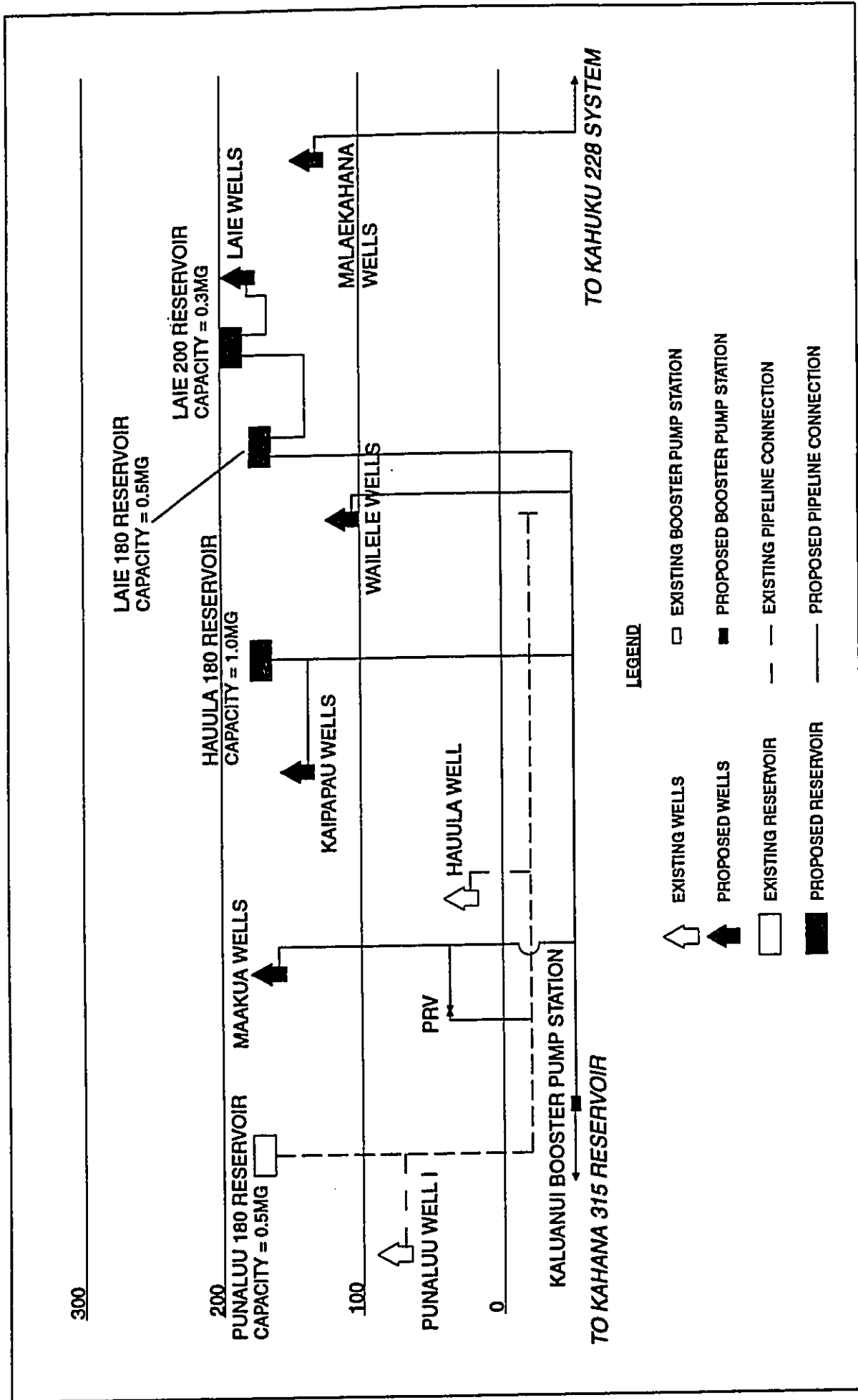

FIGURE

BOARD OF WATER SUPPLY  
HAUULA 180 SYSTEM

2-2

The Punaluu 180' Water System presently serves the Punaluu/Hauula area between Kahana Bay and Kokololio Beach. The 12-month moving average-day demand is 0.6 mgd, which is equal to the average-day pumpage of the Punaluu Well I and Hauula Wells that directly serve this system. The Maakua Well will serve as a reliable backup source to this system during peak-hour demand because the Punaluu 180'-0.5 mg reservoir does not have enough capacity as required by BWS water system standards. Any excess water will be transported toward the Kailua/Kaneohe region to supplement the deficiency in water sources in those areas.

### **2.3.1 Project Features**

#### **Well Site**

The well site (Figure 2-3) will encompass an area of approximately 0.5 acres. It will include the permanent well and pump control building with property chain-link fence. A retaining wall is proposed along the cut slope at the site.

Currently, an exploratory well (State well number 3655-02) exists at the site. Yield-drawdown and long-term pumping tests conducted on the exploratory well in June 1990 indicate that the well can have an installed pumping capacity of 1.0 mgd, an equivalent of 700 gallons per minute (gpm). Drawdown at this capacity will be approximately 5.5 feet. The maximum potential yield of the well is 1.0 mgd. Static head is 17.8 feet.

#### **Overflow Reservoir Site**

The reservoir site (Figure 2-4) will encompass an area of less than 0.1 acres. The overflow reservoir, a chain link fence and retaining wall along the cut slope will be located at the site.

#### **Pipeline**

The proposed project involves installation of a 12-inch water transmission pipeline between the well, the overflow reservoir, and an existing 12-inch pipeline stubout located at the intersection of Kamehameha Highway and Hauula Homestead Road. The pipeline will be approximately 4,350 feet long, of which 1,236 feet will be installed within the existing pavement area of Hauula Homestead Road.

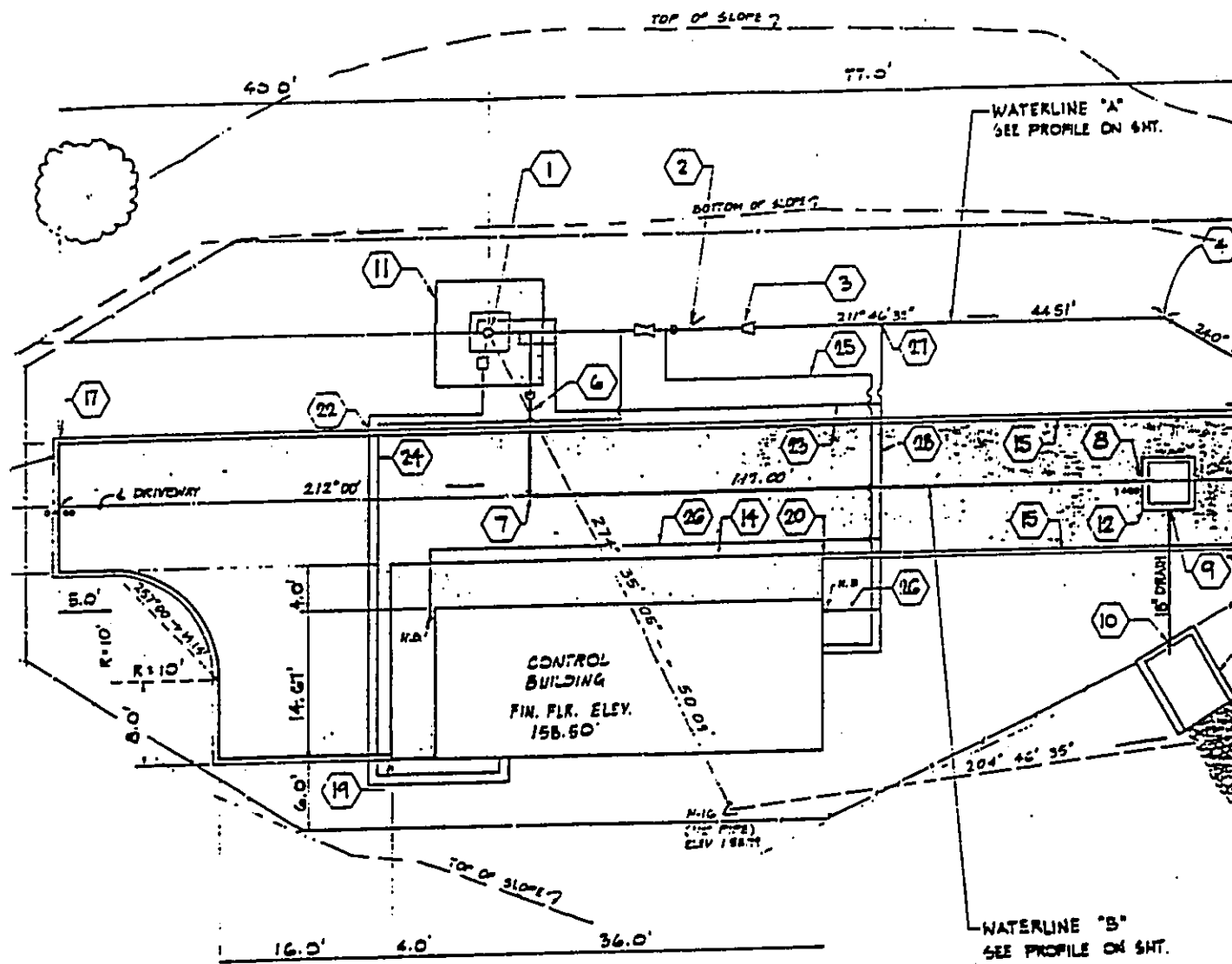

**LEGEND**

- |  |   |  |
|--|---|--|
| <p>① WELL PUMP STA 0+00 PUMP PIPING REFERRING TO "KUPAPA" 1394 871</p> <p>② STA 0+18 42 PUMP PIPING STA 0+00 WATERLINE "A" END LIMITS OF PUMP PIPING BEGIN WATERLINE "A"</p> <p>③ STA 0+05 WATERLINE "A" 1 1/2" X 8" REDUCER</p> <p>④ STA 0+44 51 WATERLINE "A" 1 1/2" 1/16 BEND 1" CONC BLOCK</p> <p>⑤ STA 0+78 51 WATERLINE "A" STA 0+00 12" TRANSMISSION PIPELINE END OF WATERLINE "A" BEGIN 12" TRANSMISSION PIPELINE</p> <p>⑥ STA 0+07 33 PUMP PURGE LINE STA 0+00 WATERLINE "B" END LIMITS OF PUMP PIPING BEGIN WATERLINE "B"</p> <p>⑦ STA 0+07 87 WATERLINE "B" 1 8" 1/4 BEND 1" CONC BLOCK</p> | <p>⑧ STA 0+85 WATERLINE "B" END OF WATERLINE "B" PENETRATE DRAIN MANHOLE WALL 1 8" SLEEVE, 12" LONG 1 8" PIPE, F.E.-P.E., 36" LONG 1 8" FLAP VALVE, F.E.</p> <p>⑨ STA 0+00 18" DRAIN BEGIN 18" RCP DRAIN PENETRATE DRAIN MANHOLE WALL</p> <p>⑩ STA 0+12 18" DRAIN END OF 18" DRAIN PENETRATE DRAIN OUTLET WALL</p> <p>⑪ WELL PUMP FOUNDATION T.O.C. ELEV. 160.50</p> <p>⑫ DRAIN MANHOLE</p> <p>⑬ DRAIN OUTLET STRUCTURE</p> <p>⑭ CONCRETE SIDEWALK</p> <p>⑮ CONCRETE HEADER</p> | <p>⑯ PRECAST CONCRETE CURB</p> <p>⑰ C. PC STA 0+00 O/S 8' LEFT END CONCRETE HEADER AND PRECAST CONC CURB</p> <p>⑱ C. PC STA 1+17 O/S 8' LEFT END CONCRETE HEADER</p> <p>⑲ C. STA 0+31 O/S 24" RIGHT END PRECAST CONCRETE CURB BEGIN CONCRETE SIDEWALK</p> <p>⑳ C. STA 0+71 O/S 8' RIGHT BEGIN CONCRETE HEADER END CONCRETE SIDEWALK</p> <p>㉑ C. PC STA 1+17 O/S 8' RIGHT END CONCRETE HEADER</p> <p>㉒ 1/4" COPPER AIR LINE IN 1" PVC CONDUIT TO WELL PUMP</p> <p>㉓ 2" COMPBELL WATERLINE TO WELL PUMP</p> <p>㉔ 3/4" COPPER PRESSURE LINE TO FLOW</p> |
|--|---|--|

SOURCE: BOARD OF WATER SUPPLY, 1992



**WELL SITE PLAN**

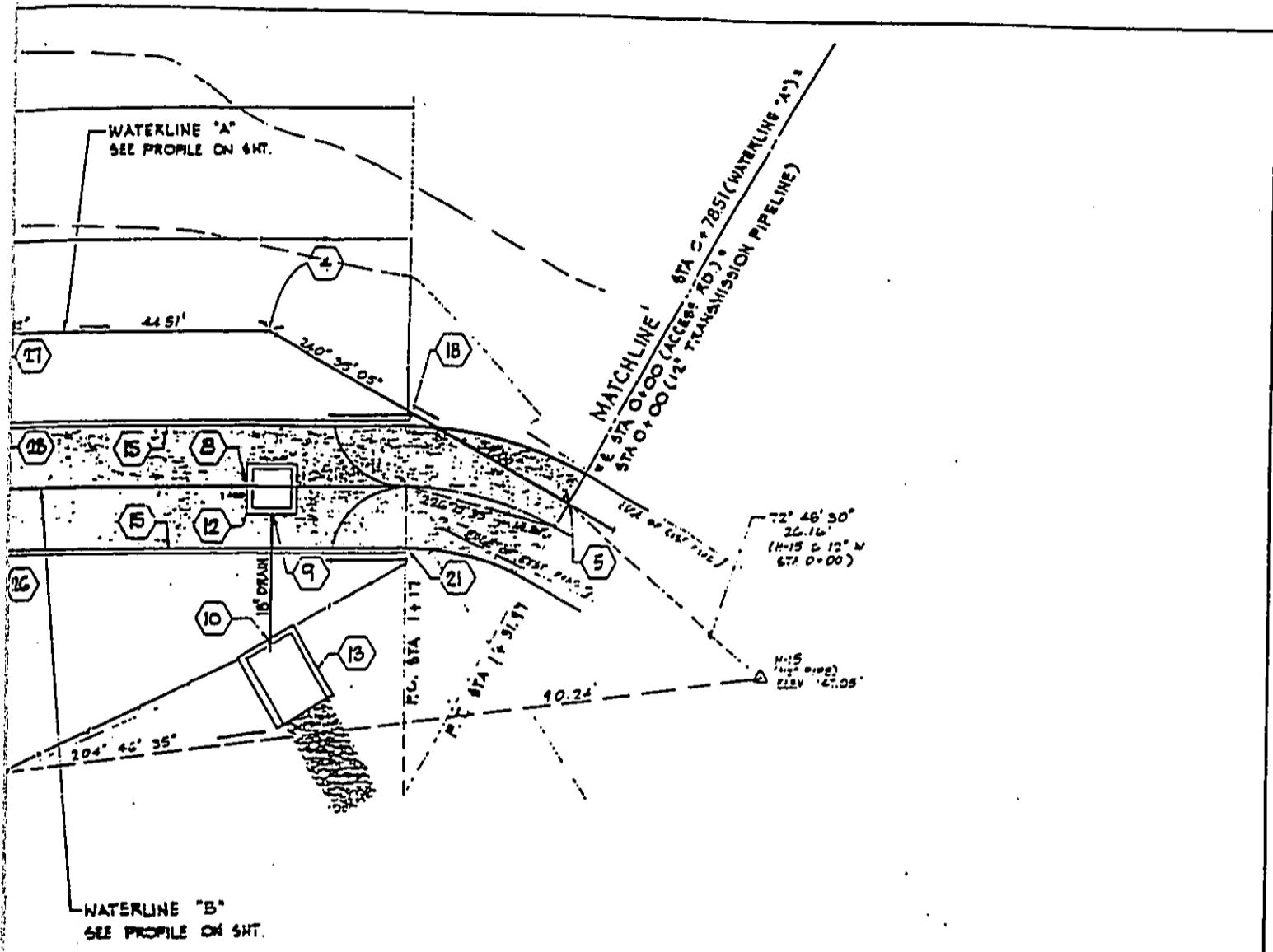

END

- (1) PRECAST CONCRETE CURB
- (2) 1" RUBBER HOSE IN 3" PVC CONDUIT TO FLOW TUBE INJECTION POINT
- (3) L. PC STA 0.00 O/S 6' LEFT END CONCRETE HEADER AND PRECAST CONC CURB
- (4) 3/4" COPPER WATERLINE TO MOSE DIB
- (5) L. PC STA 1.17 O/S 6' LEFT END CONCRETE HEADER
- (6) STA 0.25 WATERLINE "A" 8WS STD. TYPE "D" LATERAL 1 1/2" G.V. 1-TYPE "B" VALVE BOX
- (7) L. STA 0.31 O/S 24' RIGHT END PRECAST CONCRETE CURB BEGIN CONCRETE SIDEWALK
- (8) 2" COPPER WATERLINE TO CHLORINE STATION
- (9) L. STA 0.71 O/S 6' RIGHT BEGIN CONCRETE HEADER END CONCRETE SIDEWALK
- (10) L. PC STA 1.17 O/S 6' RIGHT END CONCRETE HEADER
- (11) 1/4" COPPER AIR LINE IN 1" PVC CONDUIT TO WELL PUMP
- (12) 7" COPPER WATERLINE TO WELL PUMP
- (13) 3/4" COPPER PRESSURE LINE TO FLOW TUBE

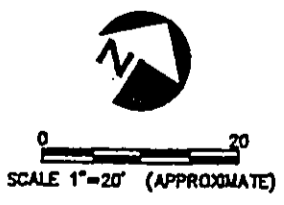

PLAN

FIGURE

2-3





### Access Road

A temporary construction access road currently provides access to the exploratory well at the project site. The proposed action will develop a permanent access road approximately 3,100 feet in length (from the access gate to the reservoir site). When completed, the road will span a 12-foot-wide pavement, and measure 16 feet from shoulder to shoulder.

The proposed access road will cross the intermittent stream of Hanaimoa Gulch about 1,800 feet north of the well site, at survey station 18+80 (access road baseline). Initial calculations indicate a peak stream runoff of 1,100 cubic feet per second (cfs) based on a 50-year storm frequency using the Curve Number Method (Nago, personal communication, 1992). A precast, reinforced concrete arch culvert span of 16 feet will be required.

### Utilities

Overhead three-phase electrical distribution is available along Hauula Homestead Road up to Hanaimoa Road, with overhead single-phase lines continuing up to and beyond Maakua Road. The project proposes to extend the three-phase distribution line along Hauula Homestead Road to the start of Maakua Road along the same routing as the existing overhead single-phase distribution. No additional street lighting is planned along Hauula Homestead Road and no outdoor lighting is intended along the new access road nor at the well site.

It is anticipated that two 4-inch electric ductlines and one 2-inch telephone ductline will be required for the underground utility system which is to be installed along the well site access road within Conservation District lands. The ductline cross-section is expected to be 24 inches wide and 30 inches deep. An above-ground, pad-mounted transformer will be provided at the well site within the fenced area.

### **2.3.2 Project Construction**

A concrete well pad and pump control building will be constructed at the well site. The control building will be a one-story masonry structure with concrete slab on grade. The roof material will be 26-gauge, hot-dipped, galvanized steel sheets coated with a fluorocarbon and epoxy paint system, and will have a tile-like appearance. The building will have plan dimensions of approximately 15 by 36 feet, and stand about 16 feet high. Piles may be required as part of the building foundation

system. Six-foot-high chain-link fencing will be installed around the site, and landscaping will be provided. In addition, a retaining wall will be constructed along the cut slope at the well site.

A 10,000 gallon reinforced concrete overflow reservoir will be constructed at the reservoir site. The reservoir will have plan dimensions of approximately 17 feet square and stand about 14 feet high. Six-foot chain-link fencing will be installed around the site and landscaping will be provided. In addition, a retaining wall will be constructed along the cut slope at the reservoir site.

Trenching will be required to install the water pipeline. The depth of trench excavation will be held to approximately 4.75 feet below the finished grade of the access road; however, along Hauula Homestead Road, especially where the pipeline crosses existing underground utilities, the depth of trench excavation may extend to 6 feet. At the connection with the existing 12-inch stubout, the excavation will be about 7.5 feet deep. Pipeline access easements have not been established at this time. They will possibly match the 40-foot right-of-way at Maakua Road.

The pipeline trench width will be 2 feet along the unpaved section of the pipe alignment. Where the pipeline is installed within existing pavement areas, the pavement will be sawcut 12 inches beyond the trench width on each side and the pavement material removed to existing subgrade. New subbase, basecourse, and asphaltic concrete pavement will be finished and installed to match the existing pavement condition. The disturbance corridor will be limited to 40 feet wide to allow for construction equipment traffic lanes, except a two locations of known archaeological sites (refer to Section 3.9), where the disturbance corridor will be limited to approximately 2 feet beyond the 10-foot wide roadbed.

Trench dewatering will likely be conducted at the connection to the existing 12-inch stubout (Kamehameha Highway). Further dewatering may be required at all open excavations when surface runoff enters the trench. Methods for dewatering and disposal of pumped water will be the responsibility of the contractor; BWS inspectors will monitor these procedures. Disposal into existing drainage facilities may be allowed with Best Method Filtration; NPDES permits may be required.

The access road will be constructed by widening, grading, and paving the existing temporary construction road. Stream crossing will required replacement of two existing 30-inch metal pipe culverts with a larger structure consisting of a precast, reinforced concrete-arch culvert with precast wingwalls on the inlet and outlet ends to provide the necessary discharge capacity and erosion

control. The precast culvert selection is based on quick installation, lower maintenance cost, attractive appearance, and structural integrity.

Assumed grading requirements for the proposed project are shown in Table 2-1. Grading of the access road will be minimal, with maximum cuts and fills on the order of 3 feet. Displaced material may be screened and graded for the roadway embankment, thereby eliminating borrow needed for the embankment. Some minor grading along the banks of the stream and along the stream bottom will be required for the crossing. Structural excavation for the culvert and wingwall footings will also be required. Maximum width of the footing may be 5 feet with a depth of 2 feet. Minor downstream sedimentation is expected during the grading and structural excavation if sufficient rainfall occurs.

As necessary, offsite staging areas will be identified by the Contractor. Coordination with the BWS and appropriate specialists (i.e., archaeologist) will be required.

Minor construction traffic, noise, and air quality (dust) disturbances will occur during construction. The contractor will be required to observe and comply with all federal, state, and local laws required for the protection of public health, safety, and environmental quality. The following construction equipment are assumed: wheel-type loaders, track-type bulldozers, dump trucks, loader-backhoe, trencher, pump installation rig, motor grader, smooth-wheel rollers, water trucks, concrete haulers/pumper, flatbed trucks, and small- to medium-capacity crane.

Table 2-1

**ASSUMED GRADING REQUIREMENTS**

Task	Amount (cy)	Hauling Trips (two-way)*
Roadway embankment	2,233	
Roadway excavation	4,788	256
Pipeline trench excavation	2,300	
Pipeline trench backfill	1,533	77
Well and reservoir site excavation	667	
Well and reservoir site excavation	163	51

\* Assumes 10-cy dump truck available.

Shoring will be required in accordance with OSHA requirements (Part 3, Chapter 132). No blasting will be allowed.

No relocation of existing utilities is anticipated. Underground electric and telephone ductline/handholes will be installed from the start of Maakua Road to the well site, parallel to the 12-inch water pipeline within the paved and shoulder area of the access road. All ductlines/handholes will be contained within the 16-foot width of the access road cross-section. No phasing of work is anticipated. The contractor may perform various portions of the construction work simultaneously, depending on available materials and labor. Construction will commence once the Conservation District Use Application (CDUA) has been approved, and is expected to be completed within 360 consecutive calendar days.

#### 2.4 PROJECT COST

The total cost for the Maakua Well Project is estimated at \$3.8 million. Cost breakdown is as follows:

Site Work	\$870,000
Construction of Control Building, Pump Building, and Overflow Reservoir	590,000
Mechanical/Electrical Work	750,000
Access Road Construction	730,000
Pipeline	570,000
Drainage System	<u>290,000</u>
TOTAL COST	\$3,800,000

## SECTION 3 ENVIRONMENTAL SETTING

### 3.1 CLIMATE

Temperatures along the windward coast of Oahu vary little throughout the year. Average monthly temperature in the Kahuku area, about eight miles northwest of the project site, ranges from about 72° to 79°F (State of Hawaii 1990). Rainfall occurs sporadically throughout the year, with most precipitation occurring during the months from November to March. Average annual rainfall at Maakua is approximately 75 inches (University of Hawaii 1983). Northeast trade wind conditions are prevalent.

### 3.2 GEOLOGY AND TOPOGRAPHY

The project site is located at the northern end of the deeply eroded Koolau Volcano, along the windward (northeastern) shoreline of Oahu. A major feature of the volcano is an extensive dike complex formed in the rift zone. These intrusive dikes formed when molten lava flowing through fissures in the volcano cooled and solidified. Rainfall that is not lost to evaporation or surface runoff infiltrates the highly porous Koolau basalt and is stored as ground water between the relatively impermeable dikes.

Stream erosion and chemical weathering are the primary geological processes that carved out Maakua Gulch along the flanks of the Koolau Volcano when the main shield-building volcanic activity ceased. The stream valley is relatively straight from its mouth at sea level to the 800-foot elevation where it begins to meander to its headwaters. Maakua Gulch is situated between Kalaunui Valley and Kaipapau Valley. These major valleys have pirated Maakua Gulch headwaters, so that the entire valley is separated from the Koolau crest by a broad ridge which also drains into Kaipapau and Kaluanui. Although Maakua Gulch is narrow, gravity-deposited talus forms a thin veneer along the valley walls, and stream-deposited alluvium occurs in the stream bed.

The well site is located on the northern bank of the stream, and about 50 feet above it, at an elevation of 160 feet. The site occurs near the contact between the older alluvium and the Koolau Volcanics, and seaward of the dike complex and marginal dike zone (Stearns 1939). The existing exploratory well was drilled into lavas that are essentially dike-free, and that were erupted from the northwest rift zone. Several thin, north-south trending dikes are mapped in the ridge between

Maakua Gulch and Kaipapau Valley. These dikes do not seem to affect hydrological conditions in the well (DOH unpublished report).

Relief at the site varies from a shallow gulch near the stream's headwaters to over a thousand feet along the mid-reach of the stream. At the well site, valley walls rise about 500 feet above the valley floor, with a slope of approximately 30 percent. The well site was previously graded to provide a level area for well installation that is approximately 50 by 75 feet in area. This area was cut into an older, consolidated talus bank. A steeply graded cut slope, approximately 18 to 20 feet in height, was excavated along the west side of the site.

### **3.3 SOILS**

A soils investigation of the well site and access road alignment was conducted in March 1992 by Ernest K. Hirata and Associates. Test borings from this investigation indicate that surficial soils at the well site generally consist of mottled brown and orange-brown silty clay with highly weathered rock fragments. The soils have a moderate to high expansion potential. Overlying the stiff silty clay along the southeast portion of the site is a layer of fill consisting of similar mottled brown silty clay with highly weathered rock fragments. The fill material was probably generated from the cut slope excavations along the uphill side of the well site. The fill ranges from 2.5 to 11 feet in thickness, and is in a relatively loose and uncompacted condition. Underlying the undisturbed silty clay at depths ranging from 1.5 to 17 feet is mottled orange and grayish-brown highly weathered rock. The rock is in a medium dense to dense condition.

The 1992 investigation further indicates that surface soil along the proposed access road alignment, including the stream crossing site, consists of brown silty clay. The clay is in a stiff condition, and, like the soils at the well site, exhibits a moderate expansion potential. Underlying the silty clay at depths of about 7 feet is mottled orange and grayish-brown highly weathered rock. The rock is in a medium dense condition.

The overflow reservoir site generally slopes downward in south and southeasterly directions. Surface soil is classified as brown silty clay with weathered gravel. The silty clay is in a stiff condition and extends to depths of approximately 4 to 5 feet. Underlying the surface soil is mottled brown completely weathered basalt in a medium dense to dense condition. Conventional shallow footings founded on the weathered basalt will be used to support the overflow reservoir and retaining wall at the site.

### **3.4 HYDROLOGY**

#### **3.4.1 Surface Water**

Maakua Stream is located downslope from the project site. This small stream drains Maakua Gulch. Listed in the Hawaii Stream Assessment (Smith 1990) as a perennial stream, Maakua Stream is classified as intermittent, because it flows year-round in its upper portions, and intermittently at lower elevations (i.e., near the project site). The base discharge of Maakua Stream is less than 0.1 mgd (BWS 1988).

Two intermittent streams flow into Maakua Stream near the project vicinity. One of these, from Kawaipapa Gulch, flows into the main stream just south of the well site. The other stream, from Hanaimoa Gulch, crosses the access road alignment approximately 1,800 feet north of the site.

#### **3.4.2. Ground Water**

The coastal plain sediments which join the stream alluvium create non-flowing artesian conditions at the well site. At the headwaters of Maakua Stream, rainfall is absorbed into the ground and is impeded by a series of volcanic dikes. These dikes supply the basal lens from which the well receives its water. The static water level of basal groundwater at the well site is 17.8 feet  $\pm$  msl. Seasonal fluctuations of several feet may occur.

Results from yield-drawdown and long-term pumping tests of the exploratory well indicate that the well taps a very permeable aquifer. Water quality data obtained during pump testing indicates low chloride levels of approximately 27 to 32 ppm (Okahara and Associates 1993). Based on these pumping tests, the BWS has determined that Maakua Well should easily produce 1.0 mgd (700 gpm) of high-quality ground water.

### **3.5 BIOLOGICAL RESOURCES**

#### **3.5.1 Vegetation**

A botanical survey of the proposed project site was conducted in April 1992 (see Appendix I). The



survey confirmed that the project area is dominated by alien plant species, most notably by the gunpowder tree (*Trema orientalis*), Christmas berry tree (*Schinus terebinthifolius*), Java plum (*Syzygium cumini*), and strawberry guava (*Psidium cattleianum*). Most of the plants in the vicinity are herbaceous weeds, but vines such as yellow granadilla (*Passiflora laurifolia*) and *Psidium cattleianum* are also common climbing over trees and shrubs.

Of the species recorded at the site during the 1992 survey, and noted during a previous botanical survey by Char (1988), about twelve are native, and only two are endemic. None of these are proposed or candidate threatened or endangered species.

### 3.5.2 Fauna

#### Terrestrial Wildlife

Introduced animal species, including small mammals and non-native birds, exist within or near the project site. None of these species are listed as candidate threatened or endangered species. Pigs that may be present in the vicinity are considered detrimental to existing vegetation and stream quality.

It is unlikely that the project site provides important habitat for any endangered native bird species. The botanical survey (Appendix I) confirmed that introduced vegetation dominates the Maakua area, and apart from waterbirds, most endemic birds on the island are limited to native forests. Exceptions include the elepaio (*Chasiempis sandwichensis*), which has been found in some areas where nearly all of the vegetation is composed of introduced plants, and the pueo or Hawaiian short-eared owl (*Asio flammeus sandwichensis*), which is found in open grasslands, pastures, forests, lava flows, and residential areas. It is possible that these birds frequent the Maakua project area, but the more common species found in a guava mixed-forest habitat include the cardinal, dove, ricebird, and Japanese white-eye, all of which are introduced (University of Hawaii 1983).

#### Stream Fauna

Maakua Stream has been determined to be of limited quality by the Hawaii Stream Assessment Aquatic Resources Committee (Smith 1990), based on the presence of only one species from the Native Species Group 2 (NG2) category. In fact, the species was incorrectly classified. The species

collected was the Tahitian prawn (*Macrobrachium* lar), an introduced species which is present in nearly all Hawaiian streams (Archer 1984).

Archer (1984) was unable to provide a rating for the biological quality of Maakua Stream because of the lack of suitable information. However, he cited evidence that up to three native species *Awaous stamineus* (endemic goby), *Atyoida bisulcata* (endemic shrimp); and *Neritina granosa* (endemic mollusc) may be present in abundance. In this event, the stream would likely deserve a high quality ranking.

### **3.5.3 Wetlands**

The major wetlands closest to the project site are in Kahuku, primarily within the James Campbell National Wildlife Refuge. Because these natural wetlands are dependent on caprock springs (fed by leakage of confined basal ground water from below), they are mostly brackish (BWS 1988).

## **3.6 AIR QUALITY**

Air quality in most areas of Oahu is generally affected by vehicular traffic and stationary sources. The general lack of high volumes of both sources, combined with the normal northeast trade wind conditions, indicate that air quality is good in the project vicinity.

## **3.7 NATURAL HAZARDS**

According to Civil Defense Tsunami Evacuations Maps, the proposed well and reservoir sites are located outside the tsunami inundation area. Virtually all of the proposed access road and pipeline alignment is also above the tsunami zone.

The entire project site is located in Zone D of the National Flood Insurance Rate Maps, an area of undetermined but possible flood hazard (Federal Emergency Management Agency 1987).

Earthquake risk at the Maakua site is minimal. The entire island of Oahu is classified within the Uniform Building Code as Seismic Zone 1, an area in which damage would be minor in the event of an earthquake.

### **3.8 CULTURAL RESOURCES**

No archaeological sites are known to occur on the Maakua well or reservoir sites; however the access road passes by archaeological Site 50-80-05-3394, and bisects Archaeological Site 50-80-05-4227. A field reconnaissance and site evaluation was conducted in April 1992 to collect information necessary to assess impacts of the proposed project to these sites (refer to Appendix II).

Site 3394 is a ceremonial or habitation-related enclosure located on the stream-side shoulder of the access road. The existing access road corridor is within one meter (3.1 feet) of Site 3394 structural components. The site is readily visible from the access road corridor, and may be easily observed by hikers traveling along the Maakua Trail.

Site 4227 appears to be an agricultural site similar in form to sites identified in other valley systems on Oahu (Kirch 1979, 1985). Newly identified and previously identified (Barerra 1984, McAllister 1933, Shun and Dies 1990, Walker and Rosendahl 1988) archaeological features are bisected by the road corridor. The access road bisects the south wall extension of Site 4227 as well as a previously unidentified wall section. The drainage feature termed a "swale" on the engineering plans (BWS 1992) and in Shun and Dies (1990) is possibly a vestigial irrigation ditch associated with apparent agricultural terraces, free-standing walls, and retaining wall features on the alluvial flat. As with Site 3394, this site is readily visible from the access road corridor and may be easily observed by hikers traveling along the Maakua Trail.

### **3.9 SOCIO-ECONOMICS**

The town of Hauula is a residential beach community composed largely of single-family homes. In 1990, Hauula had a resident population of about 3,500 (Department of Business, Economic Development and Tourism 1992). The area is characterized as rural. Surrounding land use includes low-density residential and light commercial areas with varying setbacks from the coastline, interspersed with small-scale agricultural uses. In addition, Hauula hosts a shopping center, county beach park, fire station, and elementary school.

### **3.10 ROADS AND TRANSPORTATION**

Kamehameha Highway, the nearest highway to the project vicinity, is a two-lane, asphaltic concrete

roadway under the jurisdiction of the State Department of Transportation (DOT). The right-of-way width is about 50 feet, with 30 feet of paved roadway. Various improvements by abutting landowners have moved toward the highway right-of-way. The speed limit at the vicinity of the project site is 35 miles per hour. Traffic on Kamehameha Highway is a mixture of automobiles, trucks, and buses. The Bus, Oahu's public transportation system, operates a regular schedule along this route. Private tour companies also use this route to transport tourists to and from the Polynesian Cultural Center in Laie, and other scenic attractions along the North Shore area.

The proposed water-main and access-road improvements extend along the Maakua hiking trail, Maakua Road, and Hauula Homestead Road to the Kamehameha Highway. Presently, the trail is unpaved and is approximately 10 feet wide. Both Maakua Road and Hauula Homestead Road are paved with a roadbed width of approximately 25 feet. Hauula Homestead Road is intersected by three streets (Honolu, Hanaimoa, and Anoilei) along the pipeline alignment. About 21 residential driveways stem from this road between the highway and Maakua Road.

### 3.11 VISUAL AND RECREATIONAL RESOURCES

The well site is not readily visible to nearby residents. However, hikers and hunters traveling along the trail that begins at the end of Maakua Road are able to view the site over a distance of approximately 50 feet.

Three trails branch off from the main trail at the end of the road: Maakua Gulch Trail (proposed access road alignment), Maakua Trail, and Hauula Trail. All three trails, located on State land within the forest reserve, offer interesting hiking opportunities. The three-mile Maakua Gulch Trail, which follows the stream bed, is a difficult trail that rewards hikers with a waterfall and two pools deep enough for swimming at the end of the gulch. Maakua Trail, a 2.5-mile loop, is the least traveled of the three but provides the best views of the Koolau Range. Hauula Trail, also a 2.5-mile loop, is an easy hike for families with children.

## SECTION 4 POTENTIAL IMPACTS AND MITIGATION MEASURES

The primary potential impacts associated with the development of Maakua Well as a permanent pumping station will be temporary, lasting only until project completion (about 12 months). The following subsections address these short-term impacts. Where applicable, potential long-term impacts are also addressed; however, no permanent environmental impacts are anticipated.

### 4.1 GEOLOGY AND TOPOGRAPHY

There will be no significant impact to the geology of the project area. The well site, reservoir site, and access road will be cleared of deleterious material and graded. The extent of grading will cause no major changes in topography. Maximally, grading of the access road will result in an increase or decrease of a few feet from the existing elevation; compacted fill slopes will be stabilized at slope gradients of 2:1 (horizontal to vertical) or flatter. Slopes will be planted as soon as possible upon completion of grading to reduce the effects of erosion and weathering.

Installation of the 4,350-foot length of transmission pipeline will involve excavation to a depth of approximately 4.75 to 7.5 feet below grade over most of the project. Upon completion of installation, the ground surface will be paved. Where the pipeline is installed within existing pavement area, new subbase, basecourse, and asphaltic concrete pavement will be furnished and installed to match the existing pavement condition.

### 4.2 SOILS

No significant negative impact to soils in the project vicinity is expected. Disturbance will be limited to the amount required for the project, and any waste material will be removed from the project site. Alternatively, displaced material may be screened and graded for the roadway embankment grading requirement of 2,233 cy, thereby eliminating the imported borrow required for the roadbed. Soil excavation is necessary to install the 12-inch pipeline, and will be replaced with structural fill and pipe cushion to BWS standards. The project site is not classified as important or productive agricultural land, and thus will not pose any significant impact in this regard.

Because the proposed control building for Maakua Well is located within an area of loose, uncompacted fill, additional site work is required to support the structure using conventional spread footings. The existing fill within the building area will be completely removed and recompacted. Soft soils exposed at pavement subgrade elevation or in footing excavations will also be completely removed and replaced with compacted fill. In addition, a three-foot layer of imported granular fill will be required beneath all footings and slabs on grade due to the moderate to high expansion potential of the onsite silty clay (Ernest K. Hirata and Associates, 1992).

### **4.3 HYDROLOGY**

#### **4.3.1 Surface Water**

Potential short-term impacts to existing streams could occur due to construction. For example, minor downstream sedimentation is expected during the grading and structural excavation phase if sufficient rainfall occurs. To minimize such impacts, erosion control measures, such as placement of sandbags along construction perimeters, will be implemented.

The project will have a negligible impact on the characteristics of surface runoff within the Maakua Stream watershed. Less than two acres of impermeable surfaces will be added and general runoff patterns will not be altered. In addition, all drainage features (i.e., well site, reservoir site, access road, and stream crossing) will be designed to 50-year storm standards in order to withstand flooding.

Interim instream flow standards for Windward Oahu, as adopted by the Department of Land and Natural Resources (DLNR), prohibit water removal whenever dry-weather stream flow is at or less than existing median flow. If it is demonstrated that the Maakua Stream is affected by well pumping, then the pumping will be modified, and the BWS will petition the Commission on Water Resource Management to amend the interim instream flow standards. Application of the current interim instream flow standards is expected to prevent significant dry-weather impacts to Maakua Stream.

Well pumpage effects on stream flow are best determined during dry months when runoff is minimal. However, because Maakua Stream is mostly intermittent, there is no stream flow below the well site that can be gauged. Therefore, stream-flow monitoring is not planned.

### 4.3.2 Ground Water

The source of water for Maakua Well is dike basal ground water derived from rainfall. Overpumping may subject the aquifer salt-water intrusion, as sustained overdraft of a basal lens will cause shrinkage of the lens. However, the amount of water that will be pumped from this source will be much less than the amount of water available in maintaining the viability of the aquifer (BWS 1988, DOH unpublished report). In practice, then, such a reduction is likely to be undetectable.

Movement of ground water from recharge areas to supply sources is generally protected from contaminants by a thick envelope of rock. However, contamination of basal ground water pumped by Maakua Well could originate from deep percolation of cesspools overlying the basaltic aquifer on the mauka (mountain) side of Hauula Homestead Road. Contamination from this source seems unlikely, since the well is almost a quarter mile up-gradient from the nearest house. The well casing extends to a depth of 215 feet from ground and is grouted to the surface, thereby protecting the aquifer from contamination by a surface source. The bottom of the casing is submerged about 75 feet below the water level, and therefore cuts off the top water from entering the well. Prior to final pump installation, the well will be disinfected. A chlorinator will be installed in the control building and used should contamination occur.

Storm-water discharge that will be associated with construction activity will have minimal impact on the water quality of receiving waters because the project area (three acres) is subject to disturbance. An Erosion Control Plan (ECP) will address measures to retain storm-water runoff on the project site using earth dikes and drainage swales. A stabilized construction entrance will also be specified. The ECP will be submitted to the City and County Department of Public Works for review and approval prior to construction.

Permits to discharge effluent into the municipal, separate storm-sewer system and NPDES permits will be filed for the discharge of construction dewatering and pipeline hydrotesting water. Best management practices (BMP) will be provided to control and reduce the discharge of pollutants into receiving waters. The BMP will be described in detail in the permit applications.

The BWS will monitor the quality of withdrawn water to meet applicable state and federal drinking water regulations. The agency will also measure salinity in the well for seawater intrusion into the basal aquifer. If there is a risk of intrusion, the BWS will decrease the well pumpage. The well will also be monitored for pesticide contamination.

Under current law, the State can ultimately control production and use of ground water by designating water management areas. The State Commission of Water Resource Management has recently designated Windward Oahu as such under the State Water Code, signaling that the commission intends to more closely regulate water pumping in the area. The BWS is presently applying for a Water Use Permit.

#### 4.4 BIOLOGICAL RESOURCES

##### 4.4.1 Vegetation

Vegetation at the project site is in a highly disturbed condition. Of the plant species recorded at the site (Appendix I), about twelve are native, and only two are endemic. None of these are Federal or State listed or candidate threatened or endangered species. Thus, the impact of the project to native plants will be of little consequence. The amount of vegetation removal will be limited to the area required for widening the existing access road, i.e., approximately three feet to either side of the road.

##### 4.4.2 Fauna

###### Terrestrial Wildlife

Some wildlife species (none of which are listed or candidate threatened or endangered species) may be displaced into surrounding areas during construction as a result of increased activity and noise in the vicinity, but could return to the site upon completion of construction. Thus the project will have no long-term adverse effect to the fauna of this area.

###### Stream Fauna

To minimize the potential for adverse impacts to the stream biota, construction activity near the waterway will be scheduled for completion in the shortest possible time. No waste materials from construction activities will be discarded in the stream bed or flood plain. Chlorinated water used for pipeline disinfection will not be directly discharged into the stream. A chlorination discharge plan will be submitted prior to construction, and NPDES permit requirements will be met.



Erosion, sedimentation, and discharge reduction impacts, as discussed above in Section 4.3.1 for surface water, may also occur to stream fauna. Mitigative measures proposed for potential construction-related stream impacts will also apply to the fauna.

#### 4.4.3 Wetlands

Adoption of current State Water Code and instream flow standards will ensure that local surface and subsurface water flows are preserved. There is, however, the potential for cumulative impacts to wetlands from the combined effect of overall water system improvements for Windward Oahu. Ground-water springs in Kahuku, an area approximately eight miles north of the proposed project site, are fed by leakage of confined basal ground water through overlying caprock. At this time, it is not possible to determine the extent of basal ground-water movement along the northern Windward coast across alluvial fill in stream valleys. In the event that the Koolauloa basal aquifer is substantially or completely hydrologically continuous, the proposed Maakua Well could contribute, along with other Windward wells, to the reduction in the quantity or quality of the ground water supplying the Kahuku wetlands. However, this effect would not occur if basal ground water north of Punaluu primarily leaks into coastal caprock rather than moving north to Kahuku. This potential adverse cumulative impact is addressed in detail in the Windward Oahu Regional Water System Improvements EIS (BWS 1988).

#### 4.5 AIR QUALITY

Some deterioration of air quality associated with grading and construction activities is anticipated. These actions will create increased fugitive dust and pollutant emissions from the operation of vehicles and equipment. However, these effects are short-term, and normal trade wind patterns along the Windward shore area will disperse pollutants generated by activities at the project site. Palliative methods will be implemented to mitigate the potential impacts from dust generation should this become a nuisance during project construction.

The contractor will be required to maintain internal combustion equipment in excellent working condition to minimize the emission of exhaust fumes. Additionally, the contractor is required to comply with DOH Administrative Rules Title 11, Chapters 59 and 60 (Air Pollution Control). There will be no long-term impact to air quality once construction is completed.

#### 4.6 NATURAL HAZARDS

The locations of the well site and reservoir site, about 50 feet and 80 feet above the stream bed respectively, make the possibility of on-site flooding unlikely. In addition, the well's elevation of 160 feet above sea level makes inundation by a tsunami just as unlikely. The proposed stream crossing will replace the two existing metal pipe culverts with a structure capable of containing a 50-year storm.

In the interest of public health and safety, the BWS has adopted Uniform Building Code Seismic Zone 3 design standards for all structures. Therefore, the Maakua control station and overflow reservoir will be designed and constructed accordingly.

#### 4.7 CULTURAL RESOURCES

Archaeological Sites 3394 and 4227 (refer to Appendix II) are considered to be a continuous complex of historical features, comprised of ceremonial, habitation, and agricultural structures. The limited field inspection performed in May 1992 identified additional surface structural remains, indicating that the Site 4227 area was more extensive than previously determined. Site 3394 is currently within one meter of the existing access road, and Site 4227 is bisected by the access road. Both sites have become more visible and accessible since completion of the existing access road, and will be more accessible to pedestrian traffic once the proposed road expansion is completed. The sites were also seen to be susceptible to surface water erosion along the access road.

Specific mitigation measures have been incorporated into the project design to minimize further erosional impacts to both sites. The BWS has committed to installation of drainage control structures (swales and drains) based on a calculated 50-year storm. In addition, retaining walls, which provide for slope stabilization with a minimum of site disturbance, will be used as necessary. A retaining wall is to be constructed adjacent to Site 3394 so the road can be moved farther away from the site, maintaining at least a 10-foot buffer zone.

In light of existing archaeological conditions, it has been recommended that detailed instrument mapping, limited data recovery, historical research, and stabilization be completed at both sites, prior to project construction. These and other historic site(s) in the area are also to be preserved by flagging around the site prior to road construction; activities such as pipeline trenching and grading for the access road will be monitored by a qualified archaeologist. A detailed mitigation plan shall be prepared and approved by the State Office of Historic Preservation prior to project construction.

Implementation of this plan will ensure that significant impacts are avoided or fully mitigated. A long-term site monitoring program will be instituted following construction.

#### **4.8 SOCIO-ECONOMICS**

Construction crew members will most likely come from all areas of Oahu, including some workers from the Windward area. However, the small crew size would have no significant effect relative to local or regional populations.

Impacts to surrounding land uses will be temporary. Disruption to individual residences along Hauula Homestead Road will last only as long as it takes to install each phase of the transmission main.

The BWS will be working closely with the Department of Land and Natural Resources to address concerns regarding BWS source development on State lands. Water rights and water allocation issues will be addressed in avenues beyond this EA, namely within the conditions of the CDUA and Water Use Permits.

#### **4.9 LAND USE AND ZONING**

The State land-use designation for the proposed project is Conservation, Resource (R) subzone. According to Chapter 2 of Title 13, Hawaii Administrative Rules, the Resource subzone is "to develop, with proper management, areas to ensure sustained use of the natural resources of those areas." The proposed project is a conditional use consistent with the permitted action under the Resource subzone; i.e., "governmental use not enumerated herein where public benefit outweighs any impact on the conservation district." The County zoning is Preservation (P-1). The proposed project is a permitted use within this zoning designation.

#### **4.10 ROADS AND TRANSPORTATION**

Some traffic congestion is expected once construction is underway. To minimize traffic impacts, the contractor will schedule work activity between the hours of 8:30 am to 3:00 pm, Monday through Friday, excluding any State holidays. This construction schedule will help minimize conflict with morning and afternoon peak traffic periods. The contractor shall provide ingress to and egress from driveways and public streets at all times. The contractor will abide and conform to

applicable State Department of Transportation regulations governing the use of traffic control devices at work sites, especially on sites adjacent to public streets and highways.

#### **4.11 VISUAL AND RECREATIONAL RESOURCES**

Some visual impact of the access road and well and reservoir sites is anticipated during the construction period. Construction activities will also impact on recreational use of the three hiking trails which begin at the access road, particularly Maakua Gulch Trail. Every effort will be made to ensure that public access is maintained during the construction period; however, hikers and hunters may feel that their experience is being adversely affected by equipment noise, dust, and traffic. These activities will be limited to a very small portion of the trail for a relatively short period of time. The walk from the trailhead to the well site takes approximately 10 to 15 minutes; beyond that point, hikers could continue on the Maakua Gulch Trail and enjoy the experience with no project-related disruptions. Appropriate signage will be posted during the construction period to inform trail users of the project activities. The contractor will obtain a noise permit if noise levels from construction activities are expected to exceed allowable levels as set forth in the provisions of DOH Administrative Rules Title 11, Chapter 43 (Community Noise Control for Oahu).

Operational impacts to visual and recreational resources will be insignificant. The one-story control building at the well site and the overflow reservoir will be painted in natural hues and landscaped to mitigate their visual impact. Following construction, the access road will remain open to hikers and hunters. The well and reservoir sites will be fenced to ensure public safety.

## SECTION 5 POSSIBLE ALTERNATIVES

### 5.1 NO ACTION

The BWS is mandated by law to provide for growing consumer demand for water. The proposed project is part of an overall ground-water development program to meet anticipated consumer demands for potable water on Oahu. Its objective is to increase the municipal water supply by providing an additional source of potable water in the Hauula area to serve the Windward Oahu region. Under the "no action" alternative, this objective would not be achieved. If the BWS's new water sources program is curtailed, it would not be able to adequately provide for the incoming water needs of the growing population, which may result in restrictions in new development as well as regional water shortages.

### 5.2 DELAYED ACTION

Delay of the project would initially have the same effect as the "no action" alternative. Construction at a later date may result in higher costs due to inflation and would not materially alter the environmental impacts.

### 5.3 ALTERNATE SITES

Two other sites in the Maakua area (Figure 5-1) were evaluated in the FEIS (BWS 1988). The "BWS Alternate" is located at a ground elevation of about 160 feet; the "DOWALD Alternate" is at an elevation of about 200 feet. The currently proposed site ("Maakua Wells") was selected first for exploration and subsequent development for the following reasons: it has an abundant water supply and relatively high expected yield of 1.0 mgd; it is remote from homes and public facilities; no threatened or endangered fauna or flora are known to inhabit the site; the proposed access road can be constructed to minimize impacts on archaeological sites; and the land, owned by the State, is available. The Maakua Well site is now also a preferred location for a permanent well pumping facility as the well has already been drilled there. The alternate well sites may offer opportunities for ground water development in the future. In this sense, they represent potential additional projects rather than alternatives to the proposed Maakua well.



#### 5.4 ALTERNATE SOURCES

Alternate water sources have been evaluated as part of the FEIS (BWS 1988). The BWS considered a number of alternatives to potable groundwater sources, such as desalination, development of surface and brackish water sources, and recycling of treated wastewater. However, until such alternatives become acceptable from a technical, health, and/or cost standpoint, the BWS will continue its emphasis on the development of groundwater resources.

The BWS is also actively engaged in an island-wide water conservation program to reduce the per capita water demand and extend existing supplies. This conservation program, although effective, is not a substitute solution for the BWS well development program.

## **SECTION 6 DETERMINATION**

In accordance with provisions set forth in Chapter 343, Hawaii Revised Statutes, and the significance criteria in Section 11-200-12 of Title 11, Chapter 200, this assessment has satisfactorily addressed all environmental impacts for the proposed Maakua Well project. It has been determined that an Environmental Impact Statement is not required for this project.

The proposed well development is not expected to result in significant adverse impacts to geology and soils, hydrology, stream flow, biological resources, air quality, natural hazards, cultural resources, socioeconomics, or land uses. Indirect disturbance of significant archaeological sites may occur but will be mitigated through implementation of an approved mitigation and management program. Compliance with instream flow standards will ensure that ground water pumping does not result in significant dewatering within the Maakua Stream drainage basin. Other anticipated impacts will be temporary and the quality of the area will return to preconstruction conditions.



**SECTION 7**  
**AGENCIES CONSULTED**

**FEDERAL AGENCIES**

U.S. Fish and Wildlife Service

**STATE OF HAWAII AGENCIES**

**Department of Health:**

- Safe Drinking Water Branch
- Underground Injection Control Branch

**Department of Land and Natural Resources:**

- Commission on Water Resource Management
- Division of Water and Land Development
- Division of Aquatic Resources
- Division of Forestry and Wildlife
- Division of Land Management
- Historic Preservation Division
- Office of Conservation and Environmental Affairs

Department of Transportation

Office of Environmental Quality Control

Office of Hawaiian Affairs

University of Hawaii at Manoa Environmental Center

**CITY AND COUNTY OF HONOLULU AGENCIES**

Department of Public Works  
Planning Department  
Department of Land Utilization

**OTHER INTERESTED PARTIES**

City Councilman Steve Holmes  
Native Hawaiian Advisory Council

**SECTION 8  
REFERENCES**

- Archer, Kelly M. 1984. Biological Survey and Quality Rating of Windward Oahu Streams. In: Final Environmental Impact Statement for Windward Oahu Regional Water System Improvements, Technical Appendices. Prepared by VTN Pacific.
- Barrera, W.M., Jr. 1985. Maakua, Oahu: Archaeological Survey at Proposed Well Locations. Chiniago, Inc. report prepared for VTN Pacific.
- Belt Collins and Associates. 1989. Environmental Impact Assessment for an Exploratory Well and Access Road at Maakua, Oahu. Prepared for the Honolulu Board of Water Supply.
- Board of Water Supply, City and County of Honolulu. 1988. Final Environmental Impact Statement for Windward Oahu Regional Water System Improvements. Prepared by VTN Pacific.
- \_\_\_\_\_. September 1991. Supplemental Environmental Assessment for a 16-Inch Transmission Main from Hauula to Kaipapau, Island of Oahu, Hawaii. Prepared by Wilson Okamoto & Associates, Inc.
- \_\_\_\_\_. 1992. Engineering Plans for Maakua Well. Prepared by Okahara and Associates.
- Char, Winona P. 1988. Botanical Survey, Proposed Maakua Well Site and Access Road, Koolauloa District, Island of Oahu. Prepared for Belt Collins & Associates.
- Department of Business, Economic Development, and Tourism, State of Hawaii. 1992. *The State of Hawaii Data Book*.
- Department of Health, State of Hawaii. no date. DOH Section 29 for Maakua Well (unpublished report).
- Ernest K. Hirata & Associates, Inc. 1992. Soils Investigation, Maakua Well Project, Hauula, Oahu, Hawaii, TMK:5-04-05. Prepared for Okahara & Associates, Inc.

- Federal Emergency Management Agency, National Flood Insurance Program. 1987. Flood insurance rate map, City and County of Honolulu. Panel 15 of 135; Community Panel Number 150001 0015 B.
- Kirch, Patrick V. 1979. Late prehistoric and early historic settlement-subsistence systems in the Anahulu Valley, Oahu. Department of Anthropology, Report Series 79-2, Bernice P. Bishop Museum.
- \_\_\_\_\_. 1985. *Feathered Gods and Fishhooks*. Honolulu: University of Hawaii Press.
- McAllister, J.G. 1933. *Archaeology of Oahu*. Bishop Museum, Honolulu, Hawaii.
- Minakami, Herbert H. 1990. Honolulu Board of Water Supply memo to Kazu Hayashida, June 7, 1990. Subject: Yield-drawdown and long-term pumping tests of Maakua Exploratory Well No. 3655-02.
- Nago, Terrance. 1992. Letter from Okahara and Associates to Tom Morrison, Ogden Environmental and Energy Services Company, Inc., April 21, 1992.
- Okahara and Associates. July 1993. Engineering Report for Maakua Well, Well No. 3655-02, Hauula, Oahu, Hawaii, TMK 5-4-5:01.
- Shun, Kanalei and Steven Dies. 1990. Archaeological Monitoring, Maakua Exploratory Well, Maakua Gulch, Hauula Ahapuaa, Koolauloa District, Oahu Island, Hawaii (TMK:5-4-05-1).. Prepared for Board of Water Supply, City and County of Honolulu.
- Smith, Clifford. 1990. Hawaii Stream Assessment. DRAFT. Prepared for State of Hawaii Department of Land and Natural Resources, and National Park Service.
- Stearns, H.T. 1939. Geologic Map and Guide of the Island of Oahu, Hawaii. Hawaii Division of Hydrography Bulletin 2.
- University of Hawaii, Department of Geography. 1983. *Atlas of Hawaii*. Honolulu: University of Hawaii Press.

Walker, A.T. and P.H. Rosendahl. 1988. Limited Archaeological Test Excavations: Proposed Maakua Exploratory Well Site and Access Road Project Area, Land of Hauula, Koolauloa District, Island of Oahu (TMK 5-4-5:1). Prepared for Belt Collins and Associates.

**APPENDIX I**

**BOTANICAL SURVEY  
MAAKUA WELL PROJECT**

Prepared by:

Dr. Arthur Whistler  
Ogden Environmental and Energy Services Company, Inc.

April 1992

The following is a checklist of the vascular plants inventoried during the field study at the Ma'akua project site. Also included are a few species noted by Char (1988) but not seen during the present study; these are marked with an asterisk (\*). The plants are divided into three groups, Ferns, Monocots, and Dicots. Within these groups, the species are presented taxonomically by family, with each family, and each species in the family, in alphabetical order. The taxonomy and nomenclature of the Ferns follow Lamoureux (1984); the flowering plants (Monocots and Dicots) follow Wagner *et al.* (1990). In most cases, common English and/or Hawaiian names listed here have been taken from St. John (1973) or Porter (1972).

For each species, the following information is provided:

1. Scientific name with author citation.
2. Common English and/or Hawaiian name, when known.
3. Biogeographic status. The following symbols are used:
  - I = Indigenous (native to Hawai'i as well as other geographic areas)
  - P = Polynesian introduction (introduced to Hawai'i by Polynesians before the advent of the Europeans)
  - X = Introduced or alien (not native, introduced to Hawai'i either accidentally or intentionally, after the advent of the Europeans)
  - E = Endemic (native to Hawaii)

SPECIES	FAMILY	COMMON NAME	STATUS
<b>FERNS</b>			
DAVALLIACEAE (Sword Fern Family)			
* <u>Nephrolepis cordifolia</u> (L.) Presl		kupukupu	I
<u>Nephrolepis multiflora</u> (Roxb.) Jarret ex Morton		hairy swordfern	X
LINDSAEACEAE (Lace Fern Family)			
* <u>Sphenomeris chinensis</u> (L.) Maxon		pala'a	I
POLYPODIACEAE (common Fern Family)			
<u>Phymatosorus scolopendria</u> (Burm.) Pichi Sermolli		laua'e	X

SPECIES	FAMILY	COMMON NAME	STATUS
<b>THELYPTERIDACEAE (Downy Woodfern Family)</b>			
* <u>Christella parasitica</u> (L.) Leville		oak fern	X
<b>MONOCOTS</b>			
<b>AGAVACEAE (Agave Family)</b>			
* <u>Cordyline fruticosa</u> (L.) A. Chev.		ti, ki	P
<b>ARACEAE (Arum Family)</b>			
<u>Epipremnum pinnatum</u> (L.) Engl.		taro vine	X
<b>ARECACEAE (Palm Family)</b>			
<u>Cocos nucifera</u> L.		coconut palm, niu	P
<u>Phoenix dactylifera</u> L.		date palm	X
<b>COMMELINACEAE (Spiderwort Family)</b>			
* <u>Commelina diffusa</u> N. L. Burm.		honohono	X
<b>CYPERACEAE (Sedge Family)</b>			
<u>Kyllinga brevifolia</u> Rottb.		kyllinga	X
<u>Kyllinga nemoralis</u> (Forst.) Dandy ex Hutch. & Dalziel		kyllinga	X
<b>ORCHIDACEAE (Orchid Family)</b>			
<u>Spathoglottis plicata</u> Bl.		Philippine ground orchid	X
<b>PANDANACEAE (Screwpine Family)</b>			
<u>Pandanus tectorius</u> Parkinson		screwpine, hala	I?
<b>POACEAE (Grass Family)</b>			
<u>Andropogon virginicus</u> L.		broomsedge	X
<u>Axonopus fissifolius</u> (Raddi) Kuhl.		narrow-leaved carpetgrass	X
<u>Brachiaria mutica</u> (Forssk.) Stapf		California grass	X
<u>Chloris barbata</u> (L.) Sw.		swollen fingergrass	X
<u>Chrysopogon aciculatus</u> (Retz.) Trin.		golden beardgrass	X
<u>Coix lacryma-jobi</u> L.		Job's tears	X
<u>Cynodon dactylon</u> (L.) Pers.		Bermuda grass, manienie	X
<u>Digitaria ciliaris</u> (Retz.) Koeler		large crabgrass	X

SPECIES	FAMILY	COMMON NAME	STATUS
<b>POACEAE (cont'd.)</b>			
<u>Digitaria insularis</u> (L.) Mez ex Ekman		sour grass	X
<u>Digitaria violascens</u> Link		violet crabgrass	X
<u>Eleusine indica</u> (L.) Gaertn.		goose grass	X
<u>Hyparrhenia rufa</u> (Nees) Stapf		thatching grass	X
<u>Oplismenus compositus</u> (L.) P. Beauv.		—	X
<u>Oplismenus hirtellus</u> (L.) P. Beauv.		basket grass	X
<u>Panicum maximum</u> Jacq.		Guinea grass	X
<u>Paspalum conjugatum</u> Bergius		Hilo grass	X
<u>Paspalum scrobiculatum</u> L.		rice grass	I?
<u>Sacciolepis indica</u> (L.) Chase		Glenwood grass	X
<u>Setaria gracilis</u> Kunth		perennial foxtail	X
<u>Sorghum halepense</u> (L.) Pers.		Johnson grass	X
<u>Sporobolus</u> sp.		—	X
<b>ZINGIBERACEAE (Ginger Family)</b>			
* <u>Zingiber zerumbet</u> (L.) Sm.		shampoo ginger, 'awapuhi	P
<b>DICOTS</b>			
<b>AMARANTHACEAE (Amaranth Family)</b>			
<u>Amaranthus spinosus</u> L.		spiny amaranth	X
<b>ANACARDIACEAE (Mango Family)</b>			
<u>Mangifera indica</u> L.		mango	X
<u>Schinus terebinthifolius</u> Raddi		Christmas Berry	X
<b>APIACEAE (Carrot Family)</b>			
<u>Centella asiatica</u> (L.) Urb.		Asiatic pennywort	X
<b>ARALIACEAE</b>			
<u>Schefflera actinophylla</u> (Endl.) Harms		octopus tree	X
<b>ASTERACEAE (Sunflower Family)</b>			
<u>Ageratina riparia</u> (Regel) R. King & H. Robinson		spreading mist-flower	X
<u>Bidens alba</u> (L.) DC.		beggar's-tick	X
<u>Conyza bonariensis</u> (L.) Cronq.		hairy horseweed	X



SPECIES	FAMILY	COMMON NAME	STATUS
ASTERACEAE (cont'd.)			
<u>Conyza canadensis</u> (L.) Cronq.		Canada fleabane	X
<u>Crassocephalum crepidioides</u> (Benth.) S. Moore		crassocephalum	X
<u>Emilia fosbergii</u> Nicolson		red pualele, emilia	X
<u>Emilia sonchifolia</u> (L.) DC.		pualele, emilia	X
<u>Pluchea symphytifolia</u> (Mill.) Gillis		pluchea	X
<u>Sonchus oleraceus</u> L.		sow thistle	X
<u>Vernonia cinerea</u> (L.) Less.		ironweed	X
<u>Wedelia trilobata</u> (L.) Hitchc.		wedelia	X
BIGNONIACEAE (Bignonia Family)			
<u>Spathodea campanulata</u> P. Beauv.		African tulip tree	X
BUDDLEIACEAE (Butterfly-bush Family)			
<u>Buddleia asiatica</u> Lour.		dogtail, heulo'ilio	X
CARICACEAE (Papaya Family)			
<u>Carica papaya</u> L.		papaya	X
CASUARINACEAE (Ironwood Family)			
* <u>Casuarina stricta</u> Dryand. in Ait.		she-oak, ironwood	X
CLUSIACEAE (Mangosteen Family)			
<u>Clusia rosea</u> Jacq.		autograph tree	X
COMBRETACEAE (Terminalia Family)			
<u>Terminalia catappa</u> L.		tropical almond	X
CONVOLVULACEAE (Morning-Glory Family)			
<u>Ipomea alba</u> L.		moon flower	X
* <u>Ipomea indica</u> (J. Burm.) Merr.		koali-'awa	I
CUCURBITACEAE (Gourd Family)			
<u>Momordica charantia</u> L.		wild bittermelon	X

SPECIES	FAMILY	COMMON NAME	STATUS
<b>EUPHORBIACEAE (Spurge Family)</b>			
<u>Aleurites moluccana</u> (L.) Willd.		candlenut, kukui	P
<u>Macaranga tanarius</u> (L.) Muell. Arg.		—	X
<u>Manihot esculenta</u> Crantz		cassava	X
<b>FABACEAE (Pea Family)</b>			
<u>Phyllanthus debilis</u> Klein ex Willd.		phyllanthus weed	X
<u>Acacia confusa</u> Merr.		Formosan koa	X
<u>Caesalpinia bonduc</u> (L.) Roxb.		gray nickers, kakalaioa	I
<u>Canavalia cathartica</u> Thouars		mauna-loa	X
<u>Chamaecrista nictitans</u> (L.) Moench.		partridge pea, lau-ki	X
<u>Crotalaria pallida</u> Aiton		smooth rattlepod	X
<u>Desmanthus virgatus</u> (L.) Willd.		virgate mimosa	X
<u>Desmodium incanum</u> DC.		Spanish clover	X
<u>Desmodium tortuosum</u> (Sw.) DC.		Florida beggarweed	X
<u>Desmodium triflorum</u> (L.) DC.		beggarweed	X
<u>Indigofera spicata</u> Forsk		creeping indigo	X
<u>Indigofera suffruticosa</u> Mill.		indigo, 'iniko	X
<u>Leucaena leucocephala</u> (Lam.) de Wit		koa haole, ekoa	X
<u>Mimosa pudica</u> L.		sensitive plant	X
<u>Senna surattensis</u> (N.L. Burm.) H. Irwin & Barneby		kolomona	X
<b>MALVACEAE (Mallow Family)</b>			
<u>Abutilon grandifolium</u> (Willd.) Sweet		hairy abutilon	X
* <u>Hibiscus arnottianus</u> A. Gray		kokio'o ke'oke'o	E
<u>Hibiscus tiliaceus</u> L.		beach hibiscus, hau	I
<u>Malvastrum coromandelianum</u> (L.) Garcke		false mallow	X
<u>Sida fallax</u> Walp.		'ilima	I
<u>Sida rhombifolia</u> L.		Cuba jute	X
<b>MELASTOMATACEAE (Melastoma Family)</b>			
<u>Clidemia hirta</u> (L.) D. Don		Koster's curse	X
<b>MENISPERMEACEAE (Moonseed Family)</b>			
* <u>Cocculus trilobus</u> (Thunb.) DC.		huehue	I
<b>MYRTACEAE (Myrtle Family)</b>			
<u>Lophostemon confertus</u> (R. Br.) G. Wilson and Waterhouse		brisbane box	X

SPECIES	FAMILY	COMMON NAME	STATUS
<b>MYRTACEAE (cont'd.)</b>			
<u>Psidium cattleianum</u> Sabine		strawberry guava, waiawi 'ula'ula	X
<u>Psidium guajava</u> L.		guava	X
* <u>Rhodomyrtus tomentosa</u> (Aiton) Hassk		downy myrtle	X
<u>Syzygium cumini</u> (L.) Skeels		Java plum	X
<u>Syzygium malaccense</u> (L.) Merr. & Perry		mountain apple, 'ohi'a 'ai	P
<b>OXALIDACEAE (Wood Sorrel Family)</b>			
<u>Oxalis corniculata</u> L.		wood sorrel	P?
<b>PASSIFLORACEAE (Passionflower Family)</b>			
<u>Passiflora laurifolia</u> L.		yellow granadilla	X
<u>Passiflora suberosa</u> L.		wild passionfruit	X
<b>PLANTAGINACEAE (Plantain Family)</b>			
<u>Plantago lanceolata</u> L.		narrow-leaved plantain	X
<b>ROSACEAE (Rose Family)</b>			
<u>Osteomeles anthyllidifolia</u> (Sm.) Lindl.		'ulei	I
<b>RUBIACEAE (Coffee Family)</b>			
<u>Morinda citrifolia</u> L.		Indian mulberry, noni	P
<u>Paederia scandens</u> (Lour.) Merr.		maile pilau	X
<b>SOLANACEAE (Nightshade Family)</b>			
<u>Capsicum annuum</u> L.		chili pepper	X
<u>Solanum americanum</u> Mill.		black nightshade, popolo	I?
<b>STERCULIACEAE (Cocoa Family)</b>			
<u>Waltheria indica</u> L.		'uhaloa	I
<b>THYMELAEACEAE (Akia Family)</b>			
<u>Wikstroemia oahuensis</u> (A. Gray) Rock		'akia	E

SPECIES	FAMILY	COMMON NAME	STATUS
ULMACEAE			
<u>Trema orientalis</u> (L.) Bl.		gunpowder tree	X
VERBENACEAE (Verbena Family)			
<u>Lantana camara</u> L.		lantana	X
<u>Stachytarpheta dichotoma</u> (Ruiz & Pav.) Vahl		owi	X
* <u>Stachytarpheta jamaicensis</u> (L.) Vahl		jamaica vervain, oi, owi	X
<u>Stachytarpheta urticifolia</u> (Salisb.) Sims		blue rat's-tail	X

#### REFERENCES CITED

- Char, W.P. 1988. Botanical Survey, Proposed Ma'akua Well Site and Access Road, Koolauloa District, Island of Oahu. Prepared for Belt Collins and Associates.
- Lamoureux, C.H. 1984. *Checklist of Hawaiian Pteridophytes*. Unpublished Manuscript.
- Porter, J.R. 1972. Hawaiian Names for Vascular Plants. College of Tropical Agriculture, Hawaii Agricultural Experimental Station, University of Hawaii, Department Paper Number 1.
- St. John, H. 1973. List and summary of the flowering plants in the Hawaiian Islands. Pacific Tropical Botanical Garden, Memoir No. 1, Lawai, Kauai, Hawaii.
- Wagner, Herbst, and Sohmer. 1990. *Manual of the Flowering Plants of Hawaii*. Bishop Museum and University of Hawaii Press.

**APPENDIX II**

**ARCHAEOLOGICAL SITE EVALUATION AND IMPACT ASSESSMENT  
FOR THE PROPOSED ACCESS ROAD AND WATER WELL LOCATION,  
MA'AKUA, HAU'ULA AHUPUA'A, KO'OLAULOA DISTRICT, O'AHU  
(TMK 5-4-05:1)**

**Prepared by:**

**Jim Landrum, Project Archaeologist  
Allan J. Schilz, Project Director  
Ogden Environmental and Energy Services Company, Inc.**

**August 1992  
Revised December 1992**

### ABSTRACT

The Board of Water Supply, City and County of Honolulu, contracted ERC Environmental and Energy Services Co. to conduct archaeological monitoring during the construction of the access road leading to its proposed exploratory well site in Maakua Gulch, Oahu Island (TMK: 5-4-05:1). Monitoring also included a specific task that would ensure that construction activities would not adversely impact a previously recorded archaeological site in the area, site 50-80-05-3394. A previously unrecorded archaeological site was identified during the monitoring. This new site has been assigned site number 50-80-05-4227 by the State of Hawaii Historic Preservation Program. The access road construction would have no direct adverse impact on the site; it would, however, have an adverse indirect impact. Clearing for the access road has made the site more visible and accessible than it previously had been. In consultation with the State of Hawaii Historical Preservation Program, it was deemed appropriate to plan map and locate site 50-80-05-4227 in order to record a degree of integrity for the site. The rest of the archaeological monitoring produced no other archaeologically significant data.

## TABLE OF CONTENTS

<b>TITLE</b>	<b>PAGE</b>
INTRODUCTION	1
Location, Physical Setting, and Environment	6
Physiography	6
Soils	7
Vegetation	7
Rainfall	7
Temperature	8
PREVIOUS ARCHAEOLOGICAL AND HISTORIC RESEARCH	8
METHODOLOGY	10
RESULTS	11
Site 50-80-05-3394	11
Site 50-80-05-4227	12
CONCLUSIONS AND RECOMMENDATIONS	12
REFERENCES	15

### LIST OF FIGURES

<b>NUMBER</b>	<b>TITLE</b>	<b>PAGE</b>
1	Maakua Well Site Location	2
2	Archaeological Site 3394	3
3	Archaeological Site 4227	4
4	Archaeological Site 4227	5

## INTRODUCTION

The following report presents the results of a field reconnaissance, and an archaeological site evaluation and impact assessment for the proposed access road and water well location, Ma`akua, Hau`ula *Ahupua`a*, Ko`olauloa District, O`ahu (Figure 1). The current project was completed by Ogden Environmental and Energy Services Co., Inc. for Okahara and Associates. The field study was conducted on April 23, 1992 by Jim Landrum, project archaeologist, and Cary Stine, staff archaeologist. The archaeological study was undertaken in support of a Draft Environmental Assessment (EA) which was in preparation at the time of the study.

The City and County of Honolulu, Board of Water Supply proposes to develop a water well site comprising approximately 0.5 acres, an access road from Ma`akua Street to the well pad, and a pipeline from the intersection of Hau`ula Homestead Road and Kamehameha Highway to the well. Without the appropriate mitigation measures, expansion of the existing access road and excavation of the pipeline trench would result in an adverse effect to significant cultural resources (Barrera 1984; Walker and Rosendahl 1988; Shun and Dies 1990).

No archaeological sites are known to occur on the Ma`akua well site, however, the well access road is known to pass by archaeological Site 50-80-05-3394 (Figure 2) and to bisect archaeological Site 50-80-05-4227 (Figures 3 and 4). The current study is designed to accomplish three tasks:

- 1) Determine to what extent the proposed project would impact Sites 3394 and 4227. This includes a field reconnaissance of the access road alignment and well site location;
- 2) Consultation with Okahara and Associates, the Board of Water Supply, and the State Historic Preservation Division regarding the potential impacts and alternative mitigation measures; and
- 3) Preparation of mitigation measures, guidelines for further archaeological study, and guidelines to ensure that the mitigation measures are implemented.



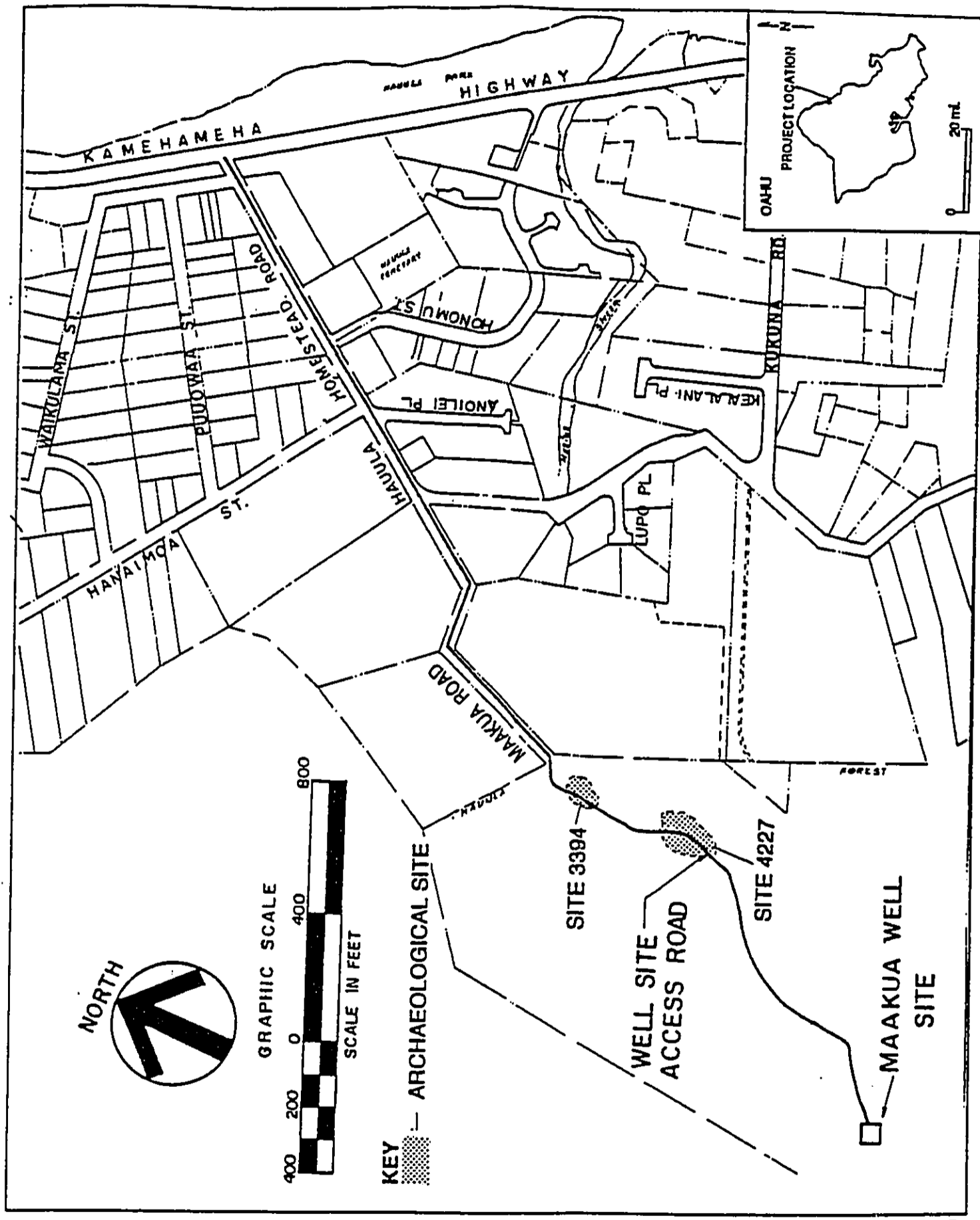

**OGDEN**  
■■■■■

MAAKUA WELL SITE LOCATION

FIGURE  
**1**



DOCUMENT CAPTURED AS RECEIVED

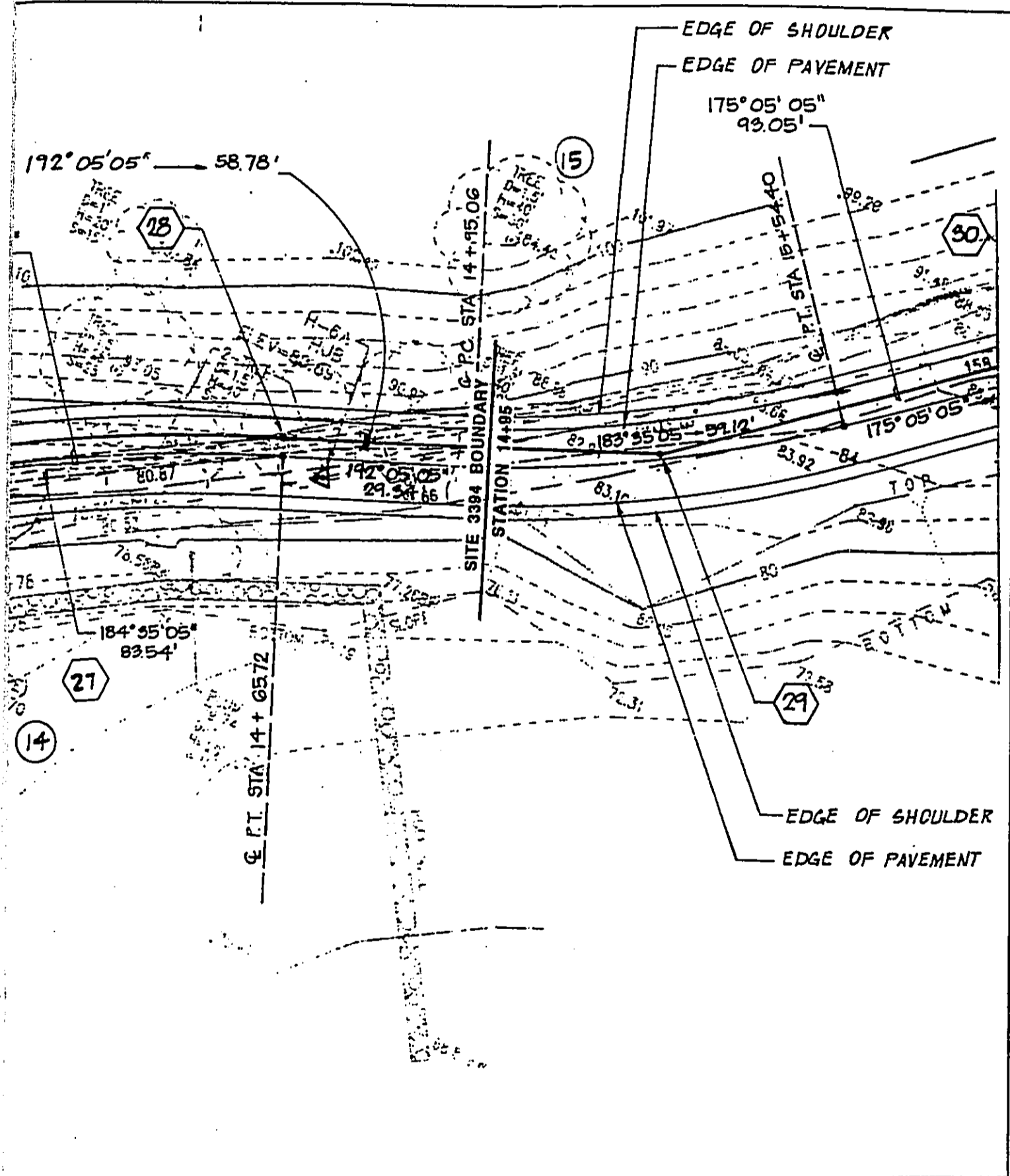

CAL SITE 3394

FIGURE  
2

DOCUMENT CAPTURED AS RECEIVED

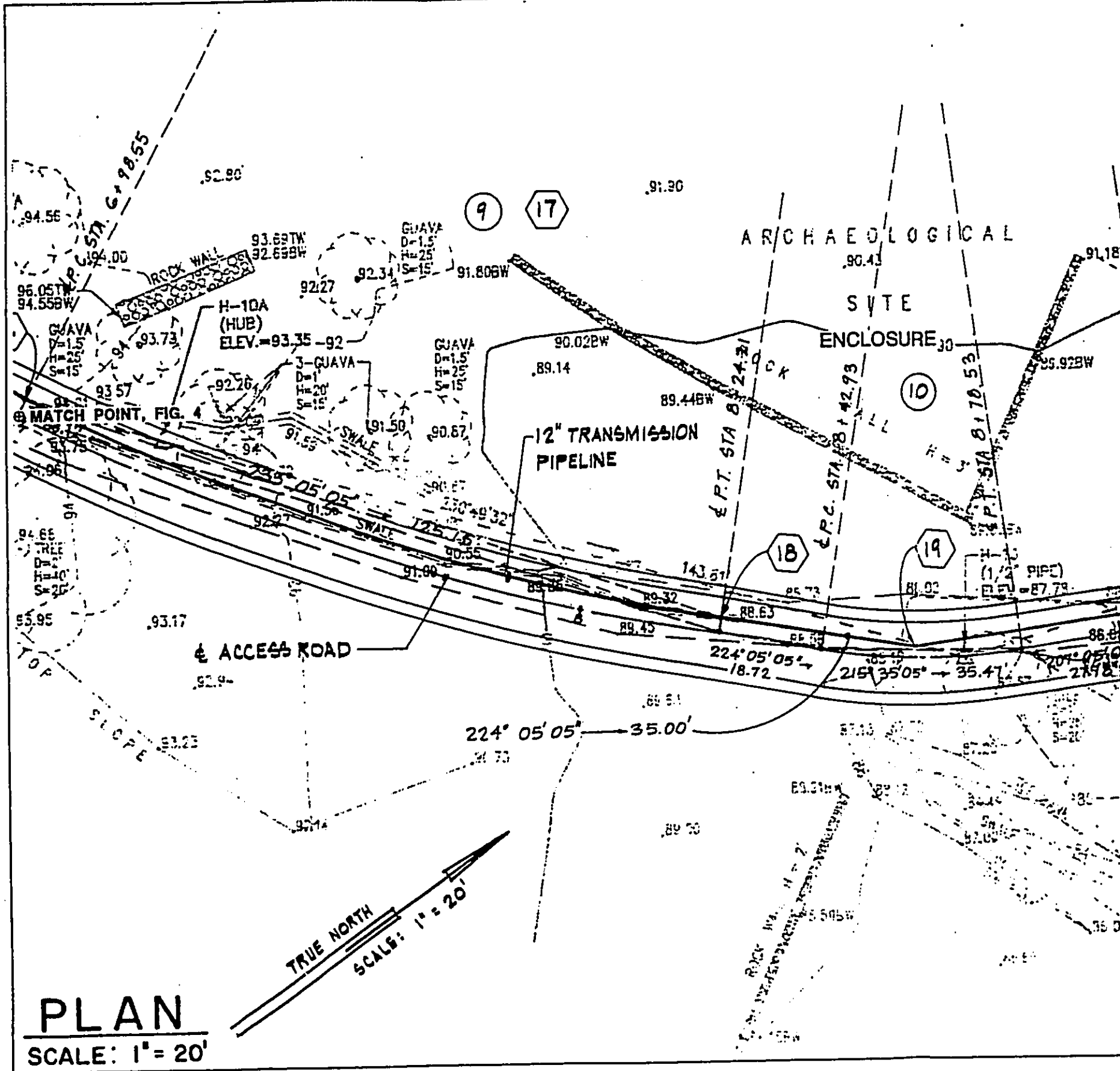

**OGDEN**  
■■■■

ARCHAEOLOGICAL SITE 4227







The limited field reconnaissance was conducted to collect the information necessary to assess impacts of the proposed project to the sites. Upon completion of the field work, and after in-house review of the findings, a telephone conference was arranged between Ogden Senior Archaeologist Allan Schilz, Project Archaeologist Jim Landrum, Okahara and Associates Engineer Masa Nishida, and Board of Water Supply Engineer Francis Fung and Planner Barry Usagawa. The telephone conference, held on April 29, 1992, was intended as an initial consultation to inform the Board of Water Supply of the preliminary findings and recommendations. A memorandum of the conference proceedings was submitted to participants on May 8, 1992. Jim Landrum had a preliminary telephone consultation with Dr. Tom Dye, Archaeologist in charge of O`ahu, Hawaii State Historic Preservation Division, on May 7, 1992 to discuss the general nature of the findings and recommendations prior to submittal of an earlier draft report (Landrum and Schilz, June 1992). Subsequently, SHPD commented on the draft (D. Hibbard letter July 10, 1992, attached). This letter was followed by telephone conversations with Dr. Dye (July 28, 1992) and Dr. Hibbard, Administrator, Hawaii State Historic Preservation Division (July 29, 1992). The results of these discussions are addressed in this report.

#### LOCATION, PHYSICAL SETTING, AND ENVIRONMENT

The Ma`akua well site project area and access road corridor is located between 40 and 160 ft (12.1 to 48.7 m) elevation above sea level, along the northwestern slopes of Ma`akua Gulch, Hau`ula Ahupua`a, Ko`olauloa District, Island of O`ahu; it is within the Hau`ula Forest Reserve Conservation District. The access road corridor commences at survey station 27+35.46, at the *makai* (east) end of Ma`akua Road, and extends inland along the northwestern side of Ma`akua Stream for approximately 2700 feet, terminating at the exploratory well head at survey station 0+00.

The access road corridor crosses the intermittent stream of Hanaimoa Gulch at survey station 18+18 (access road baseline) at approximately 60 feet (18.2 m) above sea level.

#### Physiography

Ma`akua Valley is an erosional physiographic feature of the windward Ko`olau volcano slopes commencing at approximately 2000 ft (609.6 m) above sea and terminating at approximately 40 ft (12.1 m) above sea level at the the Hau`ula coastal plain. Ma`akua



Stream is a perennial drainage that courses through this narrow valley and across the coastal plain emptying into the Pacific Ocean.

### Soils

Soils of the area are derived from the pleistocene era basalts of Ko`olau volcano, and belong to the Kawaihapai Series soils group. They are designated as Kawaihapai stony clay loam, with slopes as much as 15 percent in grade (Foote et al. 1972: 64, pl 48).

### Vegetation

Vegetation in the area is dominated by a variety of exotic shrubs and trees, primarily christmas berry (*Schinus terebinthefolius*), stawberry guava (*Psidium cattleianum* Sabine), and common guava (*Psidium guajava*). These exotic species are interspersed with a mix of lesser exotics, Polynesian introductions, indigenous, and endemic holdovers from earlier times. Char (1988) conducted a botanical survey of the project area and identified 95 species. Polynesian introductions included *ki* (*cordyline terminalis* [L.] Kunth.), *hala* (*Pandanus tectorius* Parkinson ex Z), *niu* or coconut (*Cocos nucifera* L.), *'ohia-ai* or mountain apple (*Syzygium malaccense*), and *noni* or Indian mulberry (*Morinda citrifolia* L.). Indigenous and endemic plants utilized by traditional Hawaiians that had subsistence value and economic importance included *hau* (*Hibiscus tiliaceus* L.), *popolo* (*Solanum americanum* Mill.), *huehue* (*Cocculus ferrandianus*), and *koali awahi`a* (*Ipomoea indica*). Historical period (after A.D. 1778) plant introductions of economic or subsistence value include tapioca, or manioc (*Manihot esculenta* Crantz), bittermelon (*Mormordica charantia* L.), indigo (*Indigofera suffruticosa* Mill.), guava (*Psidium guajava*), papaya (*Carica papaya* L.), date palm (*Phoenix dactylifera* L.), mango (*Mangifera indica* L.), and Job's tears (*Coix lachryma jobi* L.). In preparation of the current EA and CDUA, a recent botanical survey was conducted by Dr. Art Whistler (1992). For a more detailed review of the area vegetation, the reader is directed to that section of the EA.

### Rainfall

The *Atlas of Hawaii* depicts the Hau`ula coastal plain as having between 50 and 75 inches annual rainfall, and the lower slopes and valleys as receiving between 75 and 100 inches, while the summit of the northeast rift of Ko`olau volcano receives 250 inches (Armstrong

1983:62). Much of the precipitation falls between October and May (wet season) with the least precipitation occurring between June and September (dry season).

### Temperature

Temperatures in the area are fairly uniform year-round, with recorded monthly highs during August and September of 68 to 88 degrees Fahrenheit, and recorded monthly lows during January of 54 to 85 degrees Fahrenheit (Armstrong 1983:64).

## PREVIOUS ARCHAEOLOGICAL AND HISTORICAL RESEARCH

Three archaeological projects have been conducted within the project area over the last decade. These include archaeological reconnaissance surveys (Barrera 1984; Walker and Rosendahl 1988), testing (Walker and Rosendahl 1988), and monitoring (Shum and Dies 1990); the only previous archaeological survey was conducted by McAllister (1933). McAllister's research focused on the identification of monumental structures, in particular, religious and ceremonial sites such as *ko`a* and *heiau*, with lesser attention paid to vernacular structures such as agricultural and habitation sites, only noting them in passing in his regional descriptions. Williams (personal communication, 1992) indicated McAllister's research strategy relied heavily on informant interviews and on-site visitations with informants, who were predominantly older Hawaiians living as *kama`aina* in the various localities he visited. Apparently, when McAllister was in the Hau`ula area he could not locate any resident *kama`aina*, and therefore only identified the four sites (286 - 289) described in his report for which he had ethnographic documentation.

Handy (1940), and Handy and Handy (1972) produced two ethnographic and ethno-historical volumes pertaining to traditional Hawaiian lifeways, settlement patterns, subsistence strategies, environmental exploitation, resource acquisition, and land use. These earlier studies have formed the basis of hypotheses and formulation of research studies undertaken on O`ahu in recent years. Often, current researchers cite McAllister (1933), Handy (1940), and Handy and Handy (1972) as their primary source of historical, archaeological, and ethnographic information. Sites encountered that were not identified in these seminal reports appear to have been considered to have a lesser value as a cultural, historical, or archaeological resource, or lesser efforts have been expended researching the local histories of the sites. To date little archival documentary research or historical studies

have been undertaken in the Hau`ula area. This is perhaps important, as Handy and Handy (1972) state:

"Midway along the coastland called Ko`olau Loa (Long Ko`olau) we come upon what were once extensive wet-taro lands, beginning at La`ie and continuing through Hau`ula to Punalu`u and Kahana valleys. This was also an ideal area for offshore reef and bay fishing. It is precisely this area which was notable in legend as the residence of traditional chieftains, and for the exploits of demigods, particularly Kamapua`a, who was the incarnation of Lono the rain god and patron of agriculture...Undoubtedly this midsection of Ko`olau Loa on Oahu was an area of early settlement and of dense population, second only to that of the Waikiki-Nu`uanu-Manoa complex." [Handy and Handy 1972:271]

While previous attention has been offered to the earlier Handy (1940) references pertaining to taro cultivation in the Hau`ula area, citing that the Hau`ula coastal flats "were once all in terraces, irrigated by the valley's five streams," and "the remains of a few small terraces were still in existence in the interior of Ma`akua" [Handy 1940:91 cited in Shun and Dies (1990:3) and referred to in Walker and Rosendahl (1988:2)], there has been little attention paid to the Handy and Handy (1972:271) reference cited above. In the context of cultural, historical, and archaeological significance, the sites of Hau`ula, and Ma`akua in particular, may warrant greater levels of attention during future research than have been attended in the past. If, as Handy and Handy (1972:271) assert, the La`ie-Hau`ula-Punalu`u area was indeed an early settlement location, the second largest population center, and second-most extensive agricultural system, and home of traditional chieftains, then it would follow there is a need to investigate this area more closely, and pay greater attention to the management of cultural, historical, and archaeological resources.

Walker and Rosendahl (1988) identified, mapped, and test-excavated Site 3394. The results of their research did not provide the information necessary to make a specific determination of site function, yet indicated the structure was likely to have been either a ceremonial site, possibly an agricultural *heiau*, or a habitation site (Walker and Rosendahl 1988:9). Based upon this general assessment, the site was evaluated as significant for its information content, research value, cultural value, and as an excellent example of a site type. Recommendations included further data collection directed toward obtaining datable materials to establish site age, analyses of portable remains collected during excavation, detailed recording of previously identified and any newly identified features, and additional historical documentary research, followed by preservation and some level of interpretation (Walker and Rosendahl 1988:11). These recommendations were qualified with the

statement that "if the above recommendations are not compatible with development plans the site should be preserved 'as is' and that limited data recovery be conducted at a later date" (Walker and Rosendahl 1988:11). Again, this was further qualified with the recommendation that in the event of development, the site be avoided, flagged prior to development work, and that all grubbing in the immediate vicinity of the site be monitored by a qualified archaeologist (Walker and Rosendahl 1988:11).

Shun and Dies (1990) conducted the archaeological monitoring of the Ma`akua exploratory well site and access road corridor construction. Construction of the access road adjacent to Site 3394 was monitored, and, in consultation with the State Historic Preservation Office, the access road was allowed to come within 1 meter of the site, because of difficulties in road construction (Shun and Dies 1990:4; Shun personal communication, 1992). In addition to monitoring at this site, Shun and Dies identified Site 4227, a large core-filled enclosure wall set in a semi-rectangular fashion against the base of the talus slope and upon an alluvial flat. Set perpendicular to the long axis of the enclosure and bisecting the alluvial flat to the stream edge is an adjoining wall. The wall section was previously bisected by the Hawaii State Na Ala Hele Trails, Ma`akua Trail, and the access road was placed within this area. In consultation with the State Historic Preservation Division, mitigation of access-road corridor construction impacts was limited to mapping of the surface structural remains (Shun and Dies 1990:8). No subsurface archaeological or historical resources were identified during monitoring of the access-road corridor in the areas adjacent to the sites. Because of the proximity of Sites 3394 and 4227, it was concluded that the two sites constituted a site complex, and that they were significant for their information content, research value, cultural value, and as examples of site types (Shun and Dies 1990:8). Recommendations presented in the monitoring report included consultation with a qualified archaeologist in the event future development was undertaken in the area (Shun and Dies 1990:8).

#### METHODOLOGY

Prior to field work, previous archaeological and historical research was reviewed, and limited archival research was undertaken. Documents inspected included Barrera (1984); Walker and Rosendahl (1988); Shun and Dies (1990); McAllister (1933); Handy (1940); Handy and Handy (1972); Kirch (1985); and Sterling and Summers (1978). Archival sources briefly inspected included the Hawai`i State Archives and the Survey Division, Department of Land and Natural Resources, State of Hawai`i.

On April 23, 1992 a pedestrian survey was undertaken within the proposed Ma`akua wells project area and access road corridor. To review the proposed impact area and facilitate the location of sites and other area considerations, a set of engineering plans was carried in the field. Areas of concern were marked on the plans, with notes written on legal pads and site forms. Previously unidentified archaeological features encountered during the field inspection were located with tape and compass, and plotted on the engineering plans. Upon location of the previously unidentified archaeological resources within the corridor, the area to either side of the corridor was inspected to determine if additional resources were in the vicinity. Additional features were cursorily inspected to determine the nature and extent of the features, with attention focused on the relationship of these features to the proposed corridor and the previously identified archaeological sites (3394 and 4227).

## RESULTS

The existing access road and road cut condition does indicate some erosion has occurred, notably rivulet gullying and slumping along inclined portions of the corridor surface, the streamside shoulder, and within the roadcut on the upslope side of the road in the area adjacent to Site 3394. Sheetwash and flooding have removed the crushed coral pavement along the Site 4227 alluvial flat. Natural drainages along the corridor have been bisected. Bisection of these drainages has altered the drainage courses along the alluvial flats and is contributing to erosion in the area. Previously grubbed areas are visible on the stream-side of the access road, extending up to 15 meters from the shoulder. In these areas are large bulldozer berms and mounds of earth and rock, as well as piles of grubbed vegetation.

### Site 50-80-05-3394

This site is located between survey stations 13+35 and 14+95 on the stream-side shoulder of the access road (see Figure 2). The existing access road corridor is within one meter (3 ft) of Site 3394 structural components (*mauka* walls). The access road, road cut, and shoulder are eroding. The slope above the road cut is also eroding, due to eucalyptus trees preventing the growth of ground cover. The road cut along this portion of the slope also may be contributing to de-stabilization of the slope. The site is readily visible from the access road corridor, and may be easily observed by hikers traveling along the Ma`akua Trail.

#### Site 50-80-05-4227

This site is located between road survey stations 5+0.00 and 10+0.00. The area delimited by the two stations is an alluvial flat (see Figures 3 and 4). Site 4227 covers the entire flat, and appears to be an agricultural site similar in form to sites identified in other valley systems on O`ahu (Kirch 1979, 1985). Newly identified and previously identified archaeological features are bisected by the road corridor. The access road bisects the south wall extension of Site 4227 at approximately survey station 8+45.00, and bisects a previously unidentified wall at survey station 5+86.85. The drainage feature termed a "swale" on the engineering plans and in Shun and Dies (1990:6,7) is possibly a vestigial *auwai* (irrigation ditch) associated with apparant agricultural terraces, free-standing walls, and retaining wall features on the alluvial flat. The access road corridor has bisected the natural drainage pattern within the alluvial flat, and extensive gullying is ongoing in two areas of the flat on the stream-side of the access road. As with Site 3394, this site is readily visible from the access road corridor and may be easily observed by hikers traveling along the Ma`akua Trail.

#### CONCLUSIONS AND RECOMMENDATIONS

Shun and Dies (1990) considered sites 3394 and 4227 to be a continuous complex of archaeological features, comprised of ceremonial, habitation, and agricultural structures. Site 3394 was previously identified and assessed by Walker and Rosendahl (1988) as a probable ceremonial or possible habitation-related enclosure, and evaluated as significant under the National Register of Historic Places Criteria "a", "c", and "d". Site 4227 enclosure was identified by Shun and Dies (1990) as a probable prehistoric habitation structure and was assessed and evaluated as significant under Hawaii State Inventory of Historic Places criteria "d" and "e". The brief field inspection identified additional surface structural remains, indicating that Site 4227 area was more extensive than previously determined. Site 3394 is within the access corridor, and Site 4227 is within and bisected by the road corridor.

Previous recommendations pertaining to sites 3394 and 4227 should be reviewed, particularly in light of the proposed development, and additional features identified within the 4227 portion of the complex should be mapped. Walker and Rosendahl (1988:11) recommended that detailed instrument mapping, limited data recovery, historical research, and stabilization be completed at site 3394. This site has become more visible and

accessible since completion of the present access road and will be more accessible to pedestrian traffic once the proposed access road expansion is complete. Therefore, it is recommended that the following tasks be completed: (1) a long-term site monitoring program should be initiated to monitor and record any impacts as a result of the increased access; (2) institute protective measures or further mitigation as necessary; and (3) institute a long term management program. The need for a long term management program was stressed in the SHPD letter (Hibbard July 10, 1992).

There is evidence of erosion at Site 3394. The proximity of the current access road appears to be the primary contributing factor. Therefore, it is important that measures be taken to reduce or stop this erosion. It is recommended that the access road corridor, in the vicinity of Site 3394, be separated by no less than a 10-foot buffer zone between the site and the road. It is also recommended that the slope between the road and the site be stabilized. This realignment will require cutting further into the ridge located north of the site. This, in turn, will require stabilization, e.g., a retaining wall, to eliminate the possibility of erosion of the ridge.

As presently proposed, specific mitigation measures have been incorporated into the project design to minimize erosion impacts. The BWS has committed to installation of drainage control structures (swales and drains) based on a calculated 50 year storm. A retaining wall is to be constructed adjacent to Site 3394 and where necessary for slope stabilization, at other locations along the alignment. In addition, the present design plan calls for a 10-foot buffer zone between 3394 and the edge of the road bed.

As with Site 3394, Site 4227 will become more accessible with completion of the proposed access road. Relative to future archaeological investigations, it is recommended that instrument mapping and historical research be completed at Site 4227. It is also recommended that a limited data recovery program be developed and completed within the proposed access road corridor and a long term management program be implemented.

The recommended data recovery program should be limited to the access corridor and include the following elements:

- 1) A specific research design should be developed. This research design should include current research topics and testable hypotheses; and a field and laboratory methodology to address these topics and hypotheses. The

research topics addressed should include chronology and changes through time, resource exploitation, land use, social organization, and architectural form. Methodological site formation and transformation through time can also be studied.

2) A field program using a combination of controlled hand-excavated units and backhoe-excavated trenches should be established to collect cultural materials and stratigraphic information. The field program should also include surface collection and instrument mapping.

3) A laboratory program to process and analyze the materials collected within access corridor should be established. In addition to standard cataloging procedures, the laboratory program should include analyses of stone, bone, and shell tools. If available, organic material, e.g., charcoal, should be collected and submitted for radiocarbon assay; and bulk samples for pollen and plant macrofossil analyses should be collected.

4) A draft and final report should be produced that complies with the requirements set forth by the State Historic Preservation Division. At a minimum, this would include archival and historical background research, interviews with local residents knowledgeable of the area, research orientation and methodology, site and feature descriptions, and a discussion of the results and interpretations.

These recommended tasks should be completed prior to the proposed well, access road, and pipeline construction. Subsequently, the pipeline trenching from Kamehameha Highway to beyond Site 4227, and grading for the access road in the vicinity of Sites 3394 and 4227 should be monitored by a qualified archaeologist.

At present, no construction-related vehicular staging area within or along the corridor has been identified. Consultation with a qualified archaeologist will be necessary prior to development of a staging area to assess the presence or absence of archaeological and historical resources. In the event archaeological or historical resources are encountered, consultations with the State Historic Preservation Division and other affected agencies will be necessary to develop and implement appropriate mitigation measures.



## REFERENCES

- Armstrong, Warwick R., Editor  
1983 *Atlas of Hawai'i*. University of Hawai'i Press: Honolulu, Hawai'i.
- Barrera, W. M., Jr.  
1984 Maakua, O'ahu: Archaeological Survey at Proposed Well Locations. Chiniago, Inc. Ms. report prepared for VTN Pacific.
- Char, Winona  
1988 Botanical Survey: Proposed Ma'akua Well Site and Access Road, Ko'olauloa District, Island of O'ahu. Prepared for Belt Collins and Associates by Char and Associates: Honolulu.
- Foot, Donald E., Elmer L. Hill, Sakuichi Nakamura, and Floyd Stevens  
1972 *Soil Survey of the Islands of Kauai, Oahu, Maui, Molokai, and Lanai, State of Hawaii*. United States Department of Agriculture, Soil Conservation Service in cooperation with the University of Hawaii Agricultural Experiment Station. U.S. Government Printing Office: Washington, D.C.
- Handy, E.S.C.  
1940 *The Hawaiian Planter, Volume I: His Plants, Methods and Areas of Cultivation*. Bishop Museum: Honolulu.
- Handy, E.S.C., and E.G. Handy  
1972 *Native Planters of Old Hawaii: Their Life, Lore, and Environment*. Bishop Museum Press: Honolulu.
- Kirch, Patrick Vinton  
1979 *Late prehistoric and early historic settlement-subsistence systems in the Anahulu Valley, O'ahu*. Dept. Anthro. Report Series 79-2, BPBM.  
1985 *Feathered Gods and Fishhooks*. University of Hawaii Press: Honolulu.

McAllister, J.G.

1933 *Archaeology of O`ahu*. Bishop Museum, Honolulu.

Shun, Kanalei, and Steven Dies

1990 Archaeological Monitoring Maakua Exploratory Well Maakua Gulch, Hauula Ahupua`a, Koolauloa District O`ahu Island Hawaii (TMK:5-4-05:1). ERC Environmental & Energy Services Co.. Prepared for City & County of Honolulu Board of Water Supply.

Sterling, Elspeth P., and Catherine Summers

1978 *Sites of O`ahu*. Reprinted. Originally published 1962. Honolulu, Bishop Museum Press.

Walker, A.T., and P.H. Rosendahl

1988 Limited Archaeological Test Excavations: Proposed Maakua Exploratory Well Site and Access Road Project Area, Land of Hanula, Koolauloa District, Island of O`ahu (TMK:5-4-5:1). Paul H. Rosendahl, PhD., Inc. Ms. Report prepared for Belt Collins and Associates, Honolulu.

Whistler, Arthur

1992 Botanical Survey of the Proposed Ma`akua Well Site and Access Road Corridor. IN EA and CDUA.

**APPENDIX III**

**COMMENTS AND RESPONSES TO PUBLIC REVIEW OF DRAFT EA  
MAAKUA WELL PROJECT**

DEPARTMENT OF PUBLIC WORKS  
CITY AND COUNTY OF HONOLULU



C. MICHAEL STREET  
DIRECTOR AND CHIEF ENGINEER  
PUBLIC WORKS DEPARTMENT

March 15, 1993

ENV 93-70

MEMORANDUM

TO: KAZU HAYASHIDA, MANAGER AND CHIEF ENGINEER  
BOARD OF WATER SUPPLY

FROM: C. MICHAEL STREET, DIRECTOR AND CHIEF ENGINEER

SUBJECT: DRAFT ENVIRONMENTAL ASSESSMENT (DEA)  
THE PROPOSED MAAKUA WELL  
TRK1\_5-4-93101

- We have reviewed the subject DEA and have the following comments:
1. If dewatering activity is anticipated during the construction, storm water NPDES permits associated with construction dewatering will be required by the State Department of Health as well as the Department of Public Works, City and County of Honolulu.
  2. The DEA should address the potential impact on storm water discharges associated with construction activities on water quality of the receiving waters.
  3. The DEA should also state what structural or non-structural best management practices (BMP) will be provided to control and reduce the discharges of pollutants resulting from construction and dewatering operations.

Should you have any questions, please contact Mr. Alex Ho, Environmental Engineer at extension 4150.

*C. Michael Street*  
C. MICHAEL STREET  
Director and Chief Engineer

April 7, 1993

TO: C. MICHAEL STREET, DIRECTOR AND CHIEF ENGINEER  
DEPARTMENT OF PUBLIC WORKS

FROM: KAZU HAYASHIDA, MANAGER AND CHIEF ENGINEER  
BOARD OF WATER SUPPLY

SUBJECT: YOUR MEMORANDUM OF MARCH 15, 1993 REGARDING THE DRAFT ENVIRONMENTAL ASSESSMENT (EA) FOR THE PROPOSED MAAKUA WELL PROJECT. TRK-5-4-95: 01. HAUNA, OAHU

Thank you for reviewing the Draft EA for our proposed project. We have the following response to your comments.

1. We understand that National Pollutant Discharge Elimination System (NPDES) permits associated with construction dewatering will be required by the State Department of Health and the City Department of Public Works.
2. The storm water discharge that will be associated with construction activity will have minimal impact on the water quality of receiving waters because of the project's three acres area being subject to disturbance. An Erosion Control Plan (ECP) will address measures to retain storm water runoff on the project site using earth dikes and drainage swales. A stabilized construction entrance will also be specified. The ECP will be submitted for your review and approval prior to construction. The total project area is less than five acres and, therefore, a NPDES permit for storm water runoff associated with construction activity will not be required.
3. Permits to discharge effluent into the municipal separate storm sewer system and NPDES permits will be filed for the discharge of construction dewatering and pipeline hydrotesting water. Best management practices (BMP) will be provided to control and reduce the discharge of pollutants into receiving waters. The BMP will be described in detail in the permit applications.

If you have any questions, please contact Bert Kuloa at 527-5235.

JT:js  
cc: K. Hayashida  
B. Kuloa

93-0632

930751

PLANNING DEPARTMENT  
CITY AND COUNTY OF HONOLULU  
530 SOUTH KING STREET  
HONOLULU, HAWAII 96813



ROBIN FOSTER  
CHIEF PLANNING OFFICER  
530 SOUTH KING STREET, 5TH FLOOR  
HONOLULU, HAWAII 96813  
PH 3/93-707

March 24, 1993

MEMORANDUM

TO: KAZU HAYASHIDA, MANAGER AND CHIEF ENGINEER  
BOARD OF WATER SUPPLY

FROM: ROBIN FOSTER, CHIEF PLANNING OFFICER  
PLANNING DEPARTMENT

SUBJECT: DRAFT ENVIRONMENTAL ASSESSMENT (EA) FOR  
THE PROPOSED MAAKUA WELL PROJECT.  
TAX MAP KEY 5-4-051-01, HAAUULA, OAHU

This is in response to your request for comments on the Draft Environmental Assessment identified above. The Koolauloa Development Plan Public Facilities Map shows the subject proposal as a water well addition, site undesignated, within six years. As you know, we have recently processed your amendment proposal to change the water well symbol for the MaaKua Well from site undesignated to site determined. Our positive recommendation for this change has been forwarded with Planning Commission's concurrence to the City Council for their further action. We have no other comments to offer at this time.

Should you have any questions, please contact Melvin Murakami of our staff at 527-6020.

*Robin Foster*  
ROBIN FOSTER  
Chief Planning Officer

RF:js

May 4, 1993

TO: ROBIN FOSTER, CHIEF PLANNING OFFICER  
PLANNING DEPARTMENT

FROM: KAZU HAYASHIDA, MANAGER AND CHIEF ENGINEER  
BOARD OF WATER SUPPLY

SUBJECT: YOUR MEMORANDUM DATED MARCH 24, 1993 REGARDING THE  
DRAFT ENVIRONMENTAL ASSESSMENT (EA) FOR THE PROPOSED  
MAAKUA WELL PROJECT. IMR: 5-4-05: 1. HAAUULA, OAHU

Thank you for responding to our draft EA for our proposed well project. We will revise the EA to reflect the recent change in the water well symbol on the Development Plan Public Facilities Map to Site Determined. We note that your positive recommendation for this change along with the Planning Commission's concurrence has been forwarded to the City Council for further action.

If you have any questions, please contact Roy Dol at 527-5235.

BU:js  
cc: K. Hayashida  
R. Dol

93-0751



930753

**CITY COUNCIL**  
CITY AND COUNTY OF HONOLULU  
HONOLULU, HAWAII 96813-3065 / TELEPHONE 522-4000

STEVE HOLMES  
Councilmember  
(808) 522-4003

March 24, 1993

Mr. Kazu Hayashida  
Manager and Chief Engineer  
Board of Water Supply  
City and County of Honolulu  
630 South Beretania  
Honolulu, HI 96843

MAR 24 1993

Dear Mr. Hayashida:

Thank you for forwarding the Draft Environmental Assessment for the proposed Maakua Well Project for my review. We too hope for a negative declaration determination for this project so that it can move ahead as soon as possible.

The only concern that might surface from the community at this time is the possible disruption to the hiking trails during the construction phase. These trails are a much-valued asset to the area, and are used by locals and visitors alike. We hope that every effort will be made to minimize any inconvenience to hikers.

I appreciate the opportunity to give comments on this project. If I can assist in any other way, please feel free to contact me.

Sincerely,

STEVE HOLMES  
Councilmember, District II

SH:ma

RECEIVED  
CITY CLERK  
C&C OF HONOLULU  
MAY 10 10 02 AM '93

May 4, 1993

The Honorable Steve Holmes, Councilmember  
City Council  
City and County of Honolulu  
City Hall  
Honolulu, Hawaii 96813-3065

Dear Councilmember Holmes:

Subject: Your Letter of March 24, 1993 Regarding the Draft Environmental Assessment for the Proposed Maakua Well Station Project, TMC 5-4-05: 1, Honolulu, Oahu

Thank you for your letter regarding our proposed well project in Hauula.

We will require our construction contractor to maintain a continuous corridor through all construction areas adjacent to the Maakua Hiking Trail to minimize any inconvenience to hikers.

If you have any questions, please contact Roy Doi at 527-5235.

Very truly yours,

KAZU HAYASHIDA  
Manager and Chief Engineer

FORWARDED:

JEREMY HARRIS  
JEREMY HARRIS  
Managing Director

BU:js  
cc: K. Hayashida  
JR. Doi

93-0753

DEPARTMENT OF LAND UTILIZATION  
**CITY AND COUNTY OF HONOLULU**  
430 SOUTH KING STREET  
HONOLULU, HAWAII 96813 • PHONE 535-3411

930993

RECEIVED  
BD OF WATER SUPPLY

APR 19 11 37 AM '93



DONALD A. CLEGG  
DIRECTOR

LORETTA C. CHIEF  
MANAGER

93-00147 (JT)

April 16, 1993

MEMORANDUM

TO: KAZU HAYASHIDA, MANAGER AND CHIEF ENGINEER  
BOARD OF WATER SUPPLY

ATTN: BERT KUIOKA

FROM: DONALD A. CLEGG, DIRECTOR

SUBJECT: THE DRAFT ENVIRONMENTAL ASSESSMENT (DEA) FOR  
MAAKUA WELL PROJECT - HAUULA, OAHU, HAWAII  
TAX MAP KEY: 5-4-51\_01

We appreciate the opportunity to review and comment on the Draft Environmental Assessment (DEA) for the above mentioned project which includes the construction of a well site, installation of a water pipeline, replacement of stream crossing culverts, and reconstruction of the existing access road.

Approximately 200 feet of the proposed water transmission pipeline, proposed along Hauula Homestead Road and mauka of its intersection with Kawahewa Highway, falls within the Special Management Area (SMA). The installation of the underground pipeline, however, is not defined as "development" under the SMA Ordinance, Chapter 25, Revised Ordinances of Honolulu, and is therefore, exempt from its regulations.

We concur with the description on page 4-6 of the DEA which states that the project site is in the State-designated Conservation District and in the P-1 Restricted Preservation District. As such, the uses, structures and development standards are governed by the appropriate State agencies, and not the City and County of Honolulu Land Use Ordinance.

Should you have any questions, please contact Joan Takano of our staff at 527-5038.

DAC:ak  
sideswell.jnc

*Donald Clegg*  
DONALD A. CLEGG  
Director of Land Utilization

May 4, 1993

TO: DONALD C. CLEGG, DIRECTOR  
DEPARTMENT OF LAND UTILIZATION

FROM: KAZU HAYASHIDA, MANAGER AND CHIEF ENGINEER  
BOARD OF WATER SUPPLY

SUBJECT: YOUR MEMORANDUM DATED APRIL 16, 1993 REGARDING THE DRAFT ENVIRONMENTAL (EA) FOR THE PROPOSED MAAKUA WELL PROJECT, TMK: 5-4-05: 1, HAUULA, OAHU

Thank you for responding to our draft EA for our proposed well project.

We note that the portion of our project within the Special Management Area (SMA) is not defined as "development" and is therefore, considered exempt from the SMA Ordinance.

The project is situated within the State Conservation District requiring a Conservation District Use Application which has been filed with the Office of Conservation and Environmental Affairs of the Department of Land and Natural Resources.

If you have any questions, please contact Roy Doi at 527-5235.

BU:jc  
cc: K. Hayashida  
/R. Doi, *RD*

93-0993





State of Hawaii  
 DEPARTMENT OF LAND AND NATURAL RESOURCES  
 Commission on Water Resource Management  
 Honolulu, Hawaii

APR 15 1993

MEMORANDUM

TO: Mr. Edward E. Henry, Acting Administrator  
 Office of Conservation and Environmental Affairs

FROM: Rae M. Lord, Deputy for *[Signature]*  
 Water Resource Management

SUBJECT: Draft EA and CDUA: Maakua Well Project, Hawaii Town, Oahu

SL

The location of the Maakua Well Project on State-owned land raises an important issue of concern that needs to be immediately addressed by the Honolulu Board of Water Supply. This issue relates to the "first-call" rights of the Department of Hawaiian Home Lands (DHHL) to waters developed on State-owned lands, as provided for in Section 221 of the Hawaiian Homes Commission Act and as further emphasized in Act 325, 511H 1991.

For your information, DHHL is currently preparing a strategic plan for the reservation of water to expedite the settlement of the Hawaiian Home lands, and will be utilizing the above laws to achieve its objectives. The Division of Water Resource Management (DWRM), as staff to the State Commission on Water Resource Management (CWRM), has been working closely with DHHL to identify those areas of potential water supply where DHHL might exercise its "first-call" rights. Because the Maakua well site is a candidate location, DWRM is recommending that the Honolulu BWS discuss its project proposal with DHHL to determine the extent of DHHL's interest in the use of the Maakua waters. Later, when the Honolulu BWS seeks to obtain the permission of DLNR to utilize the State's Maakua land for its well, DHHL's position on its need for the Maakua water can be factored into DLNR's evaluation of the Honolulu BWS's land use request.

Aside from the above, DWRM is satisfied that the Honolulu BWS is aware of the need to obtain certain water-related permits from the Water Commission.

GM:ly  
 attachments

APR 15 1993



STATE OF HAWAII  
 DEPARTMENT OF LAND AND NATURAL RESOURCES  
 DIVISION OF WATER AND LAND DEVELOPMENT

P. O. BOX 21  
 HONOLULU, HAWAII

MAY -5 1993

TO: Mr. Edward Henry, Acting Administrator  
 Office of Conservation and Environmental Affairs

FROM: Manabu Tsunomori, Manager-Chief/Engineer *[Signature]*

SUBJECT: Application for Proposed Use of State-Owned Conservation District Lands,  
 Review for Chairperson's Signature, Maakua Well on State Property Identified  
 as LMS-5-4-5-1 in Hawaii, Oahu

Reference A) OCEA memo of March 23, 1993, same subject  
 Reference B) Telephone conversation between Sen. OCEA, and Ed Lan,  
 DOWALD, on April 21, 1993

Water supply is very critical to the State's development programs. State water credits in the Honolulu area are exhausted and diminishing in the other few areas where we have credits. State projects may, in the near future, be stopped or delayed because of lack of State water credits with the Honolulu Board of Water Supply (BWS).

The Department of Land and Natural Resources' Conservation District Use Application should require the BWS and the State to negotiate a fair and reasonable agreement in water credits for State programs for the use/lease of this land for water supply. The agreement should be based on the fair and reasonable value of the land itself plus the fair and reasonable value as a source of water supply. The Division of Water and Land Development (DOWALD) is willing to assist the Division of Land Management in the lease negotiations.

EL:jk

C: Div. of Land Management

State of Hawaii  
Department of Land and Natural Resources  
DIVISION OF AQUATIC RESOURCES

March 30, 1993

MEMORANDUM

To: Paul Kawamoto, Program Manager  
Aquatic Resources and Environmental Protection

From: Bill Devick, Program Manager  
Recreational Fisheries 567-0110

Subject: Use of State-owned conservation lands

Comments Requested By: Roger Evans, OCEA  
Date of Request:  
Date Received:

Summary of Proposed Project

Title: Application for Proposed Use of State-Owned Conservation  
District Lands, Review for Chairperson's Signature, File MA-2638

Project By: Board of Water Supply, City and County of Honolulu

Location: Hauula, Oahu

Brief Description: The project involves construction of a permanent water well located at low elevation in Maakua Gulch near Hauula Town at the site of an existing exploratory well within a State Conservation Land Use District. Construction will include well facilities, a pipeline, a stream crossing, and reconstruction of an existing access road. The draft EIS stresses no long-term environmental impacts.

Comments: The draft EIS references the Hawaii Stream Assessment Report (HSA) but fails to interpret the criteria in the Aquatic Resources section to the point of identifying the introduced Tahitian prawn, *Macrobrachium* sp., as a native species. It further misrepresents the document as a satisfactory representation of the relative environmental quality of a given stream, even though the Aquatic Resources section explicitly states that the report "should not be construed as a reliable assessment of the quality of stream habitats or of the occurrence and distribution of biota within or between streams"; and that it "should not be substituted either for needed research or the proper biological reconnaissance surveys that should be performed and carefully reviewed before development is seriously considered." Instead, the draft EIS has used the Report exactly as it was not intended to be used, as a substitute for a proper biological reconnaissance. The reconnaissance was not performed and should be required before approval of a COUA is considered.

We believe that Maakua Stream may be of considerably greater value biologically than was suggested in the Hawaii Stream Assessment Report. Spawning populations of one endemic goby, *Lenipies* sp., have recently been found in Kahuani Stream below Maakua. In Kahuani Stream immediately above Maakua, and in the upper reaches of Waiale Stream south of Lala. The latter stream was thought to be devoid of native fishes when the HSA was completed but when a biological reconnaissance was required as part of another development proposal, all 5 endemic freshwater stream fishes as well as other native aquatic species were found. Waiale is usually dry in its lower reaches. We actually have unconfirmed reports of *Lenipies* in the upper reaches of Maakua and are fairly certain that other endemic species are present. *Lenipies* concolor, it should be noted, has been proposed for listing as an endangered species. At the time the HSA was completed, this species was thought to be extinct on Oahu but improved survey techniques have discovered small populations in several streams on the island.

The draft EIS suggests that current status quo instream flow regulations will eliminate any legal opportunity for dewatering the stream, indicates a stream flow monitoring system will be established, and states that if the stream flow is reduced, pumping will be modified and the instream flow standards amended. The latter is not within the authority of the Board of Water Supply and would require approval from the State Commission on Water Resource Management. If such an application is filed, hard questions will have to be answered about the effect of the proposed activity on native aquatic biota. The failure to incorporate any kind of biological reconnaissance for stream biota in the draft EIS indicates that the many ramifications of this possibility have not been considered very seriously.

We believe that a careful biological reconnaissance of the entire Maakua Stream should be a prerequisite for any decision-making on this proposal.

Conditions described in the draft EIS suggest the ground in the area of the well is highly permeable and leaves the impression that stream dewatering attributable to pumping from the well is likely. Monitoring is proposed to detect any such dewatering. An adequate description of the monitoring procedure is needed to assure its adequacy for the purposes intended.

  
Bill Devick

Department of Land & Natural Resources  
Division of Forestry and Wildlife

MEMORANDUM

May 17, 1993

TO: Ed Henry, OCEA  
FROM: Michael G. Buck, Administrator *MB*  
SUBJECT: Well Project and Miscellaneous Improvements, Hanalei  
File No. OA-2636 *SL*

We have reviewed File No. OA-2636 and have the following comments:

- 1) The draft EA for the Proposed Maunaloa Well Project satisfactorily addresses our concerns regarding the access to the Hanalei trail system. Although the biker may feel inconvenienced because of the proposed construction, his access to the trails will not be impeded.
- 2) The draft EA did not address the use of the area as a burning area. It should be known to the applicant that burners do use the area and necessary precautions need to be taken during construction of the project.
- 3) We have no objections to the proposed request. A fire contingency plan is required prior to construction.

cc: Oahu Branch  
Na Ala Hele

RECEIVED  
MAY 18 PM 3:45  
OCEA  
OCEA

April 22, 1993

LOG NO: 7167  
DOC NO: 9304TD32

MEMORANDUM

TO: Edward E. Henry, Acting Administrator  
Office of Conservation and Environmental Affairs *SL*

FROM: *Don Hubbard*  
Historic Preservation Division

SUBJECT: Application for Proposed Use of State-Owned Conservations District Lands, Review for Chairperson's Signature  
(File No. MA-2836)  
Hanalei, Keolu, Oahu  
TRM: 2-4-5

The DEA correctly notes the presence of two historic sites, Sites 50-80-05-3394, a probable shrine or small heiau and -4227 an agricultural site, along the route of the well site access road. The adverse effects of this project on these two historic sites and on unrecorded historic features in the vicinity is noted.

The DEA proposes the following actions to mitigate these adverse effects and these should be attached as conditions to any approved Conservation District Use Permit to ensure "no adverse effect" to these sites:

A detailed mitigation plan shall be approved by the Historic Preservation Division prior to project construction. This mitigation plan shall include the following: 1) detailed instrument mapping, limited data recovery, historical research and stabilization shall be completed by a qualified archaeologist at sites 50-80-05-3394 and -4227 prior to project construction 2) an inventory of previously unrecorded historic features in the vicinity of the project shall be completed 3) road grading and pipeline trenching activities shall be monitored by a qualified archaeologist 4) historic sites shall be clearly marked and construction crews briefed to ensure that construction activities do not have an "adverse effect" on historic sites 5) a long-term plan for preservation as-is of site 3394, which includes a monitoring program, shall be developed.

If you have any questions please call Tom Dye at 587-0014.

TD:bek

COPY

COPY



September 17, 1993

Mr. Keith W. Ahue  
Page 2  
September 17, 1993

Mr. Keith W. Ahue, Chairperson  
Department of Land and Natural  
Resources  
State of Hawaii  
P. O. Box 621  
Honolulu, Hawaii 96809

Dear Mr. Ahue:

Subject: Your Letter of May 13, 1993 Regarding the Conservation District Use  
Application (CDUA), File No. OA-2636, for the Proposed Maakua Well  
Station Project. TMK: 5-4-05: 1, Hawaii, Oahu

9

We have the following comments to the concerns of your department regarding the proposed well station project:

Commission on Water Resource Management

It is our understanding that the Department of Hawaiian Home Lands will be contacting us when they are ready to discuss the reservation of water as it relates to specific water resource development sites.

Division of Water and Land Development (DOWALD)

We agree that water is critical to State development projects. However, we feel that the status of State water credits with the Board of Water Supply (BWS) should have no bearing on permit decisions for the proposed well. We recommend the State consider the development of sources in the Windward area, including Maakua Well, to resolve the problem of lack of State water credits with BWS.

Division of Aquatic Resources (DAR)

We are presently processing a contract with Ogden Environmental Consultants to conduct the stream survey. The scope of work will be submitted to DAR prior to finalizing the contract to ensure all concerns are met.

We clarify that stream flow monitoring during test pumping was not conducted because there was no stream flow in the vicinity of the well to monitor. Maakua Stream is an intermittent stream in the lower reaches and only flows during periods of high rainfall in the form of runoff. Test pumping for wells near flowing streams is usually conducted during dry weather periods to determine an accurate assessment of effects on stream flow. We understand the Commission on Water Resource Management is in the process of establishing a standard aquifer test pump protocol to estimate surface water impacts.

Division of Forestry and Wildlife

We are aware that the well project may affect the Haauiua hiking trail system, and therefore, will require our contractor to provide continuous access to hikers and hunters. The access road is expected to ease ingress and egress to the area.

We note the area is designated for hunting, and therefore, necessary precautions will be taken during construction, such as adequate signage at the access road entrance to inform hunters of the construction project. The majority of hunting occurs during the weekend which should not conflict with the regular work week of this project.

A fire contingency plan will be submitted for review and approval prior to construction.

Historic Preservation Division (SHPD)

We acknowledge the access road is adjacent to two archaeological sites which are significant in terms of historic and cultural value. We are presently in the process of finalizing a contract with Social Research Systems Co-op to provide all archaeological services for the project. In coordination with SHPD, a mitigation plan will be developed, including mapping, limited data recovery, historical research, an inventory survey of any unrecorded historic features, monitoring of road grading and pipeline trenching activities, flagging of historic sites, and education of construction crews about the significance of these sites.

The specifics of the Board of Water Supply's responsibility regarding a long-term plan for monitoring and preservation of site-3394 will be discussed with SHPD.

BOARD OF WATER SUPPLY  
CITY AND COUNTY OF HONOLULU



COPY

Mr. Keith W. Ahue  
Page 3  
September 17, 1993

Additional Comments

We would also like to add, in the current CDUA, the construction of the necessary electric power lines installed along the access corridor to provide power to the pump and telemetering equipment necessary to integrate the pump station into the existing water system.

We attach our comments to the Department of Land Utilization regarding exemptions to the Special Management Area requirements.

If you have any questions, please contact Roy Doi at 527-5235.

Very truly yours,

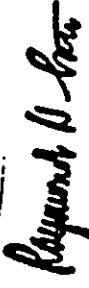
  
for KAZUO HAYASHIDA  
Manager and Chief Engineer

Attachment

cc:  Ogden Environmental  
Hawaiian Electric Company

STATE OF HAWAII  
DEPARTMENT OF HEALTH

RECEIVED



93 JUN 4 9 06 AM  
STATE OF HAWAII  
DEPARTMENT OF HEALTH

STATE OF HAWAII  
NATURAL RESOURCES  
STATE OF HAWAII

P. O. BOX 2075  
HONOLULU, HAWAII 96820

June 1, 1993

JOHN C. LEVIN, M.D.  
DIRECTOR OF HEALTH

92-352/epo

To: The Honorable Keith W. Ahue, Chairperson  
Department of Land & Natural Resources

From: John C. Levin, M.D. *John C. Levin*  
Director of Health

Subject: Conservation District Use Application

Applicant: Board of Water Supply  
File No.: CA-5/7/93 - 2636  
Request: Maakou Well Project  
Location: Hauula, Oahu  
TRK: 5-4-5; 1

RECEIVED  
93 JUN 4 11 55 AM  
DLNR  
OCEA

Thank you for allowing us to review and comment on the subject request. We have the following comments to offer:  
Drinking Water

1. The draft EA/CDUA summary (page 5-3) does not mention the required source approval by the Director of Health. As new sources of water are developed, it will be necessary to comply with Hawaii Administrative Rules, Title 11, Chapter 20, "Potable Water Systems." Section 11-20-29 of Chapter 20 requires that all new sources of potable water serving a public water system be approved by the Director of Health prior to its use. Such an approval is based primarily upon the submission of a satisfactory engineering report which addresses the requirements set in Section 11-20-29.

Underground Injection Control

Our previous comments in the letter dated April 16, 1993, to Kasu Hayashida, Manager and Chief Engineer, Board of Water Supply, are still applicable. For your convenience, we are restating these comments:

1. The proposed well site lies above the Underground Injection Control (UIC) line.

The Honorable Keith W. Ahue, Chairperson  
June 1, 1993  
Page 2

2. Our UIC map (71/2 minute USGS quadrangle map in scale 1:24,000) indicates the presence of adjoining wells. Described below are the well numbers, their approximate distances, and bearings with respect to the proposed well location.

Well No.	Approximate Distance in Feet (CBL) Bearing
3655-01	4100 ft., NE
3655-02	2000 ft., NE
3554-01	3100 ft., SE
3554-02	3100 ft., SE
3554-03	3100 ft., SE
3554-04	3100 ft., SE
3554-05	3600 ft., SE

3. The Department of Health encourages the practice of wise sanitation procedures during construction to insure that contamination is not introduced into the well from construction activities. Down hole drilling tools and well construction material should be clean and should not be contaminated with toxic materials associated with the operation of engines and machinery.

If you have any questions, please contact Stuart Yamada (Drinking Water) or Jaime Miranda (Underground Injection Control) of the Safe Drinking Water Branch at 586-4258.

c) Safe Drinking Water



STATE OF HAWAII  
DEPARTMENT OF HEALTH  
P. O. BOX 2071  
HONOLULU, HAWAII 96843

April 16, 1993

Mr. Kazu Hayashida  
Manager and Chief  
Board of Water Supply  
City & County of Honolulu  
630 South Beretania Street  
Honolulu, Hawaii 96843

Dear Mr. Hayashida:

Subject: Draft Environmental Assessment (EA)  
for the Proposed Maikua Well Project  
Hauula, Oahu  
TKK: 5-4-05: 01

Thank you for allowing us to review and comment on the subject project. We have the following comments to offer:

Underground Injection Control (UIC)

1. The proposed well site lies above the Underground Injection Control (UIC) line.
2. The UIC map (7 1/2 minute USGS quadrangle map in scale 1:24,000) indicates the presence of adjoining wells. Described below are the well numbers, their approximate distances and bearings with respect to the proposed well location.

Well No.	Approximate Distance in Feet (ft), Bearing
3655-01	4100 ft., NE
3655-02	2000 ft., NE
3554-01 &	5100 ft., SE
3554-02	
3554-03	8300 ft., SE
3554-04	6100 ft., SE
3554-05	5600 ft., SE

3. Department of Health encourages the practice of wise sanitation procedures during construction to insure that contamination is not introduced into the well from construction activities. Down hole drilling tools and well construction material should be clean and should not be contaminated with toxic materials associated with the operation of engines and machinery.

Mr. Kazu Hayashida  
April 16, 1993  
Page 2

If you have any questions, please contact Jaime Rimando of the Safe Drinking Water Branch at 586-4259.  
Very truly yours,

*John C. Lewin*

JOHN C. LEWIN, M.D.  
Director of Health  
c: Safe Drinking Water Branch

JOHN C. LEWIN, M.D.  
DIRECTOR OF HEALTH

In reply, please refer to:  
93-086/epo

September 16, 1993

John C. Lewis, M.D.  
Director of Health  
State Department of Health  
P. O. Box 3378  
Honolulu, Hawaii 96801

Dear Dr. Lewis:

Subject: Your Letter of April 16, 1993 Regarding the Draft Environmental Assessment for the  
Proposed Muihwa Well Project. DRK-5-4-93; J. Hamaoka, Oahu

Thank you for your letter regarding the proposed potable water source project. We provide the following response to the concerns of your department:

1. Safe Drinking Water

We are presently developing the required engineering report in accordance with Hawaii Administrative Rules, Title 11, Chapter 20, Section 29 and will be submitting the report with complete water quality analysis for your review and approval prior to bringing the well online on-site.

2. Underground Injection Control

Thank you for providing information on the adjacent well's numbers and coordinates. We understand the existing well is above the UIC line.

The construction contractor will be required to utilize proper sanitation procedures during construction to ensure that the well is not contaminated.

If you have any questions, please contact Roy Doi at 527-5233.

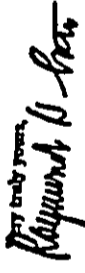
Very truly yours,  
  
for KAZUO HAYASHIDA  
Manager and Chief Engineer

cc: Office of Conservation and Environmental Affairs, DNR  
Office Environmental

BU:rk  
cc: K. Hayashida, Engineering, A. Doi (V)  
93-1060





**NATIVE HAWAIIAN ADVISORY COUNCIL**

A Hawaiian Organization  
1088 Bishop Street, Suite 1204, Honolulu, Hawaii 96813  
Telephone (808) 522-1445  
Facsimile (808) 522-0300

1671-707

1993 May 7

TO: Honolulu Board of Water Supply  
630 South Beretania Street  
Honolulu, HI 96843

RE: Maekua Well Project Draft Environmental Assessment and  
Conservation District Use Application

**GENERAL ANALYSIS**

With regard to the provisions of Title 11, Chapter 200, we find the Draft Environmental Assessment (DEA) deficient in the following areas:

(4) General description of the action's technical, economic, social, and environmental characteristics.

Particularly socio-economic impacts of county use of state water sources with no apparent compensation to the Hawaiian Homes Commission, ceded lands trust, and Office of Hawaiian Affairs.

(6) Identification and summary of major impacts and alternatives considered, if any.

Particularly well site alternatives and access road alignment alternatives to completely avoid archaeological sites worthy of preservation and restoration.

(7) Proposed mitigative measures, if any.

Particularly mitigation of socio-economic impacts.

Cumulative impacts complicated by archaeological and socio-economic concerns demand much more in-depth assessment and evaluation, and possibly the preparation of Supplemental EIS for reviewing them from a regional perspective. Water rights and water allocation issues have become much more complex and controversial since 1988.

PH 22 3 27 1993

D

**DETAILED ANALYSIS**

PAGE SECTION

-2- ...the BWS is requesting a subdivision to remove the project area from the Division of Forestry's jurisdiction.

What problems arise from continuing DOPAW jurisdiction? More detail on subdivision proposal, process, and implications needed.

-4- What are the implications of County General Plan Preservation (P-2) Designation?

COOA SUPPLEMENT

1.0. What is State land title status?

2. Access road bisects site 50-80-05-4227 (appears to be an agricultural site) in two places, yet "sites can be avoided during construction."

This is contradictory - will sites be avoided, and if so, how?

B-3

B.7 Well construction and pump installation permits from the Commission on Water Resource Management would be required. "Permit to Withdraw Water from a Ground Water Control Area" has not been a DWR permitting process since 1987, when the Ground Water Control Act was repealed in favor of the State Water Code.

1-1 The 1988 BWS FEIS discussed the potential need for supplemental EIS's for individual components of the Regional Water System Improvements. This and subsequent DEA's for these components should be carefully examined for the need to complete SEIS, especially in view of changing legislative, regulatory, political, and socio-economic frameworks.

2-1

2.3

What is State land title status?

2.3

What is the quantity of demand in the Haunala area that will be primarily served by the proposed well? How might this change as additional regional water system improvement components are brought on-line?

2-8

2.4

How is the estimated total project cost allocated among project components?

3-5

3-6  
The possible presence of a vestigial irrigation ditch and associated pondfield complexes previously drawing water from Meakua stream deserves closer attention, especially since there may be groundwater impacts on streamflow sources of ditch water.

3-6

3-9  
When surface water is harvested from State lands, the State issues water licenses and collects fees for this harvest. Thirty percent of these revenues go to the Hawaiian Homes Commission (HHC), and 20% of the remaining revenues go to the Office of Hawaiian Affairs (OHA). Strangely, unfairly, and perhaps illegally, no similar compensation is paid for extraction of groundwater underlying State lands. This is a severe impact upon Native Hawaiian Beneficiaries of the Hawaiian Homes Commission Act (HHCA) and the Public Land Trusts, who see mismanagement and erosion of their trust assets at every turn. Details of subdivision plans and other land use arrangements between HHC and BLMR must be presented in the DEA on order to fairly identify, assess, and evaluate these impacts (see testimony from Native Hawaiian Legal Corp. attached). Furthermore, the implications of Act 325 (1991 legislature) for development of water sources on State lands needs to be addressed within this DEA and the Windward Regional FZIS (probably as a Supplemental EIS). The DEA should summarize how HHC and the State involve HHC, HHCA beneficiaries, and OHA in planning for and allocation of water source development on ceded lands.

4-2

4-3.1

Instream flow standards do regulate ground water management in that changes to instream flow resulting from groundwater development require approval of the Water Commission. HWS does not have the choice to "voluntarily comply," and would probably provide a different explanation today than that interpreted by DEA preparers from 1988 HWS documents.

As stated by USGS District Chief William Meyer in recent Water Commission meetings, the most important part of monitoring instream flow effects of groundwater development in to create mutually agreeable monitoring and analysis protocol prior to implementing project construction and monitoring. Discussion of planned monitoring protocol would be instructive to the DEA, and could dictate more stringent review in a Supplemental EIS.

4-3

4-3

The current proper terminology is water management area, not ground water control area.

4-6

4-7

Mitigation may not be the best strategy for cultural resource protection. The EA should assess the significance of irreparably destroying a portion of what may have been a pondfield agricultural complex. Because this complex is on unencumbered State land, it could possibly be restored and put back into operation by cultural preservationists and practitioners.

4-8

Assessment of socioeconomic impacts fails to address questions of county-state development agreements and compensation for disposition of public land trust assets.

5-1

5-3

Comparative assessment of alternative sites cannot be accomplished with the limited information presented in this section. At the very least, a matrix showing the advantages and disadvantages of each alternative site should be presented, including but not limited to the listed criteria of expected yield, resiliency, presence of endangered species, archaeological impacts, and land availability.

5-1

5-4

Conservation of existing supplies and reductions in existing use are two primary alternatives which appear in many water source development assessments and which should not be ignored here.

APPENDIX II

i

Statements that "access road construction would have no direct adverse impact on the site" (50-80-05-4227) are contradicted by statements that "the well access road is known to ... bisect archaeological Site 50-80-05-4227."

The documented and suspected cultural and historical importance of the area suggests that mitigative alternatives other than archaeological data recovery and interpretation be studied. The DEA should address alternatives which achieve preservation in place, site protection, site restoration, and reactivation in cultural uses.

Mahalo

*for* *Gayle M. Brown*

David L. Martin, Vice-President

encl: HHL testimony of 4/6/93 on SCR 140/SR 115  
DHHL Statewide Water Strategy Unmet Needs  
Draft Press Release of 4/26/92 - "Hawaiian Groups Outraged"

pc: Okahara and Associates  
Ogden Environmental and Energy Services Co., Inc.  
Office of the Governor, State of Hawaii  
Office of Environmental Quality Control  
DLNR Office of Conservation and Environmental Affairs  
DLNR Division of Land Management  
DLNR Commission on Water Resource Management  
Water Commissioners  
Land Board members  
Planning Committee, Honolulu County Council  
County Council members  
Native Hawaiian Legal Corp.  
Hawai'i- La'ieka'ala Association, Inc.

----- DRAFT -----  
FOR IMMEDIATE RELEASE  
April 16, 1992

**HAWAIIAN GROUPS OUTRAGED BY KEY LEGISLATORS' ACTIONS  
TO REDUCE PAYMENTS FOR CEDED LANDS RIGHTFULLY  
OWED TO THE DEPARTMENT OF HAWAIIAN HOME LANDS  
(Honolulu, HI)**

Current versions of bills pending before legislative conference committees have sparked outrage from a broad coalition of Hawaiian organizations and individuals concerned about the low priority being given native Hawaiians by the 1992 Legislature. Members from the following organizations protested the cuts in funding for the Department of Hawaiian Home Lands (DHHL) and infrastructure for homestead development, and the attempts to deprive native Hawaiians of revenue due from ceded lands in Lahaina, Kona, and elsewhere being eyed by the Housing Finance Development Corporation (HFDC) to build affordable housing. They oppose the sale of ceded lands that will cut back or stop payments mandated by federal and state law from lands due to native Hawaiians:

Waimoa Advisory Council	State Council of Hawaiian Homestead Assn.
Hawaiian Business/Professional Assn.	Nakoa Ka'ala
Waimoa Hawaiian Homestead Assn.	Ne Kane O Ke Miao
Kalaheula Hawaiian Homestead Assn.	Pah'e'eh'e Ridge Hawaiian Homestead Assn.
Ho'olehua Hawaiian Homestead Assn.	Makuru Hawaiian Homestead Assn.
Native Hawaiian Legal Corporation	

These groups are critical of Maui Representative Joseph Scuitto's decision to base compensation to native Hawaiians for the use of ceded lands being leased to sugar companies on the current (agricultural) value of the lands, rather than on their future residential or commercial value (SB 2485 and SB 2638). Under federal and state law, the DHHL is entitled to receive 30% of all such revenues; OHA is supposed to receive an additional 20%.

"Why should native Hawaiians continue to subsidize these projects? Why should we continue to accept less revenue than that to which we are entitled under our constitution and federal law, just so that politicians can claim credit for building affordable housing?" asked Charles Ke'ala'i of the Pah'e'eh'e Ridge Homesteaders Association.

They also criticize Representative Souki's decision to slash a \$24 million compensation package for the illegal uses of DHHL trust lands by public agencies since statehood to \$12 million (SB 2855). He also deleted a provision supported by Representative David Hegino that would have allowed future compensation when more information becomes available. They are particularly upset at this action since his counterpart Maui Senator Mamonu Yamasaki simultaneously slashed a Capital Improvement Projects (CIP) bill targeted for Hawaiian home lands infrastructure development from \$25 million to \$13.9 million (HB 2922). The higher figure is still less than 3% of what the DHHL will eventually need to build homes for the 20,000 currently on the waiting list.

"With all the national attention from the Wall Street Journal article last September, I had hoped that native Hawaiians would finally have the opportunity to break the chains of legislative and bureaucratic inaction that have jailed them for the past seventy years," commented, Sonny Kanfhe, the subject of this year's *Na Hoku Hanohano* awarding-winning song, "Broken Promise." He added that, "the 1992 Legislature should give more native Hawaiians higher funding priority so that they can be placed back on their lands."

"We understand that the State is trying to save money with the drop in tax revenues," said Hawaiian attorney, Bruce Kappeler, a Hawaiian Civic Club member, "but look at the items in the budget they gave higher priority, e.g. mass transit (\$53 million)." "Besides, the State spent millions in cash just in the past two years on boondoggle projects for the rich, like *Kaka'ako* (\$120 million). And is the second UH stadium (\$32 million) and parking lot more important than DHHL needs? The money set aside for affordable housing (\$120 million) wasn't even spent!"

"And where was the planning for this compensation bill when the state was flush with a surplus only a year ago?" asked Mahaleli Kama'u, Executive Director of the Native Hawaiian Legal Corporation. "We had a \$750 million cash surplus only two years ago. At that time only \$7 million of the cash surplus went to the DHHL." Currently, the DHHL gets only .01% of the total operating budget of the state - about 1 penny for every \$10 spent by the state for its total operations.

Adds Lela M. Hubbard of *Nakoa Na'ike*, "Is the Legislature ignoring justice for Hawaiians to ensure that the extinction of Hawaiians predicted for 2040 becomes a reality? What is our 'Hawaiian' Governor doing for native Hawaiians?"

As the legislature nears deadline for finalizing these bills, these Hawaiian groups called upon all voters, in support of the Hawaiian homes program, especially constituents of

Senator Yamasaki and Representative Souki, to communicate their opposition to the actions of the money committee chairs from Maui. They urge their supporters to ask for a restructuring of the state's priorities to give greater justice and equity for native Hawaiians as the 100th year commemoration of the overthrow of Queen *Lili'uokalani* approaches.

Media Contact:

DAVID CHUN (Telephone: 943-8599)  
ALAN MURAKAMI (Telephone: 521-2302).



**NATIVE  
HAWAIIAN  
LEGAL  
CORPORATION**

RECEIVED APR 08 1993

11:30 P. HONOLULU HAWAII TEL: (808) 531-2527 FAX: (808) 537-4700

TESTIMONY OF CARL C. CHRISTENSEN  
NATIVE HAWAIIAN LEGAL CORPORATION

Before the Senate Committees on  
Planning, Land and Water Use Management and  
Governmental Operations, Environmental Protection,  
and Hawaiian Programs

April 6, 1993

S.C.R. 140/S.R. 115

Requesting that the Department of Land and Natural  
Resources Report on the Fairness of Compensation Being  
Generated by the Private Use of Ceded Lands

Native Hawaiian Legal Corporation is a public interest law firm committed to the assertion, protection, and defense of Native Hawaiian claims to lands, natural resources, and related entitlements. NMLC represents actual or potential beneficiaries of the programs of the Department of Hawaiian Home Lands and Office of Hawaiian Affairs which are funded in part by entitlement payments derived from State revenues from Ceded Lands. As Native Hawaiians, they are disproportionately impacted when the State fails to obtain adequate compensation for private use of public lands which are assets of the Ceded Lands Trust established under § 5(f) of the Hawaii Admission Act.

The State Must Obtain Fair Market Value when Making Dispositions of Ceded Lands for Purposes not Authorized in § 5(f) of the Hawaii Admission Act.

Section 5(f) of the Hawaii Admission Act provides that the lands obtained by the State of Hawaii under § 5(b) of the Admission Act, together with revenues derived from those lands,

"shall be held by [the State of Hawaii] as a public trust for the support of the public schools and other public educational institutions, for the betterment of the conditions of native Hawaiians, as defined in the Hawaiian Homes Commission Act, 1920, as amended, for the development of farm and home ownership on as widespread a basis as possible, for the making of public improvements, and for the provision of lands for public use."

The § 5(f) Trust or Ceded Lands Trust is unique in federal law in that in no other instance has the United States

Testimony of Carl C. Christensen on SCR 140/SR 115  
April 6, 1993, p. 3

making entity and without compensation to the § 5(f) Trust, is a "public use" permissible under § 5(f) of the Admission Act. The language of § 5(f) restricting the use of the Trust's assets to five purposes would become mere surplusage if BLMR could certify virtually any disposition of these assets as a "public use." Where courts have allowed such a broad interpretation of "public use" (and they have done so in the context of eminent domain proceedings, not when reviewing state trust obligations imposed under the terms of land trusts governing management of lands granted to states by the federal government), they have done so on the basis of a clear legislative statement authorizing the particular action at issue. Instead, BLMR's position with regard to the uncompensated disposition of public lands rests only on an executive branch determination of "public use" and is wholly without legislative support.

The State of Hawaii is a major landowner, and it is inevitable that those who would use public lands for private benefit would seek to obtain those lands at as low a price as possible. It appears that BLMR has assumed for itself the power to subsidize certain economic activities by the expedient of declining to obtain rents that reflect the rates that would be charged by a private landowner for equivalent lands. Because of the particular manner in which the State of Hawaii has chosen to fund BLMR and OHA, such invisible subsidies impose a disproportionate economic burden on Native Hawaiians, whose revenue entitlements are thereby improperly reduced in a manner that is all but invisible to the public and that thus escapes scrutiny by the Legislature and the public. While the State of Hawaii may well choose, as a matter of public policy, to subsidize certain private economic activities as a device to ensure the continued economic viability of certain enterprises or industries, these activities should be subsidized by legislative appropriation, not by the renting out of public lands at concessionary rates without legislative authority or oversight.

In contrast to the impropriety of subsidizing non § 5(f) purposes, it may well be appropriate for the Legislature to determine that fulfillment of the State's obligation under § 5(f) to encourage "the development of farm and home ownership on as widespread a basis as possible" requires that sub-market rentals be provided to families whose farms or residences are located on Ceded Lands and who would be unable to compete economically if the lands they now occupy were put up for lease at public auction. Such action would be consistent with the State's obligations under § 5(f), and in fact the Legislature has provided relief for such hardship cases in the past. It is not the intent of this testimony to discourage such actions, but only

\*See, e.g., Act 237 (1988); Act 249 (1990).

Testimony of Carl C. Christensen on SCR 140/SR 115  
April 6, 1993, p. 5

Recommendation. DNR should be asked to establish a timetable for replacing all outstanding revocable permits with leases issued at public auction, unless continued disposition of particular parcels can be shown to be justified on a case-by-case basis by a foreseeable change in use that makes disposition by lease inappropriate at this time or that hardship conditions exist with regard to particular classes of tenants that justify legislative relief. DNR should be asked to identify any additional manpower required to accomplish this task in a timely manner.

Disposition of State-Owned Water Resources by Executive Order Rather than by Water License as Contemplated Under § 171-59, H.R.S.

Section 171-58, H.R.S., authorizes the DLNR to dispose of state-owned water rights. Although § 171-58 would, by its terms, appear to be the only statutory authority for the transfer of such water rights, the DLNR also makes such water resources available for use by the various county water supply agencies through the mechanism of a conveyance of land by executive order under the supposed authority of § 171-11, H.R.S. Such a transaction raises two areas of concern. *(copy attached to DLNR memorandum)*

First, transfer of state-owned water resources by executive order, rather than by issuance of a water license in accordance with § 171-58, could have the effect of avoiding the requirement of § 171-58(9) that DLNR consult with DHRL prior to disposing of state-owned water resources. This requirement was imposed by the 1991 Legislature, Act 325, § 3, for the purpose of facilitating the reservation of such rights for the future benefit of DHRL and its beneficiaries. Because § 171-11 contains no similar requirement, DHRL may be unable to protect the rights of its beneficiaries in such a transaction by seeking an appropriate reservation of rights in a timely manner.

Second, the use of the executive order mechanism may unfairly reduce the revenues that would otherwise be received by DHRL and OHA. This is so because county water agencies charge

<sup>1</sup>Section 213(b)(5)(A) of the Hawaiian Homes Commission Act and Article XII, § 1, of the State Constitution provide that 30% of state receipts from water licenses shall be paid into the Native Hawaiian Rehabilitation Fund for the use of the Department of Hawaiian Home Lands. Where the affected government-owned waters are assets of the public land trust established under Art. XII, § 4, of the State Constitution (which encompasses all lands included in the public trust established under § 5(f) of the Hawaii Admission Act), under § 10-13.5, H.R.S., 20% of all

*IN PARTIAL COPY SUPPLIED DHRH*

*DNR  
Murtin*

DHHL STATEWIDE WATER STRATEGY  
UNMET NEEDS

The attached summary identifies Hawaiian home lands on each island, the current and foreseeable homestead water needs for each tract, and a "tool box" of strategies for meeting the requirements of Act 325, SLH 1991, as they might apply to each tract.

PURPOSE: This summary is meant to serve as a reference for discussions between DHRH, the Commission on Water Resources Management (CWRM, or "Water Commission"), the Division of Water and Land Development (DOWLD) of the Department of Land and Natural Resources (DLNR), the Department of Agriculture (DOA), and the counties' departments of water supply and general planning.

Act 325: The public trust requires a balancing of multiple values, including homestead needs, public health and safety, economic development, environmental protection, among others. The intent of Act 325 was to resolve the conflicts that exist among these by thoughtful integrated, long-term planning.

"Current" needs mentioned in Act 325 are here defined as those falling within a ten-year time frame, roughly corresponding to DHRH's ten-year plan of subdivision improvements to serve lots already awarded from 1984 through 1988; these are well underway and intended for completion by 1998 or 1999.

"foreseeable" needs mentioned in Act 325 are defined here as those beyond the ten-year time frame, expressed as priority development areas currently being planned. These are conceptual and subject to change; some areas indicate no existing plans for the foreseeable future, but this does not preclude future development there, even within the same time frame, if conditions change.

Strategies: Counties are bound to deliver services to developers who have met all other permit requirements, and are fully occupied within a six-year time frame to meet these immediate needs. Our efforts are aimed at reserving water resources on state lands to give public agencies flexibility in dovetailing our respective longer-range infrastructure planning.

By setting aside adequate sources for current and foreseeable needs now, we remove the threat of inadequate funding undermining rights to available water. This does not address infrastructure appropriations directly, and funding will continue to be a constraint upon the pace of development.

Maps and Charts: The maps indicate approximate acreages as of 1978. There are outstanding land claims that are changing these figures; when current efforts reach completion, new base maps will be prepared. The charts show only Unmet needs; some projects underway already have water commitments. Each figure is a total of all projects for each tract, in two categories, potable supply for households, and irrigation for agriculture. The number of households is abbreviated "no-du" (dwelling units); the agricultural acreage is abbreviated "ac-irrigation" total sums the amounts needed for all "du" the "irrigation" total sums amounts needed for agricultural acreage.



October 8, 1993

Mr. David L. Martin  
Page 2  
October 8, 1993

Mr. David L. Martin  
Native Hawaiian Advisory Council  
1088 Bishop Street, Suite 1204  
Honolulu, Hawaii 96813

Dear Mr. Martin:

Subject: Your Letter of May 7, 1993, Regarding the Draft Environmental Assessment,  
(EA) for the Proposed Maakua Well Project. TMK: 5-4-05: 1, Hawaii, Oahu.

1) Thank you for your comments on the Maakua Well project. We have revised the text of  
the EA to address your comments where appropriate and provide the following response  
to your major concerns:

General Analysis

1. We understand the Department of Hawaiian Home Lands will be contacting us to discuss the reservation of water as it relates to specific water resource development sites. Water developed at Maakua is planned to meet the water demands of State projects.
2. Alternative well sites were considered prior to the exploratory well construction. However, since this well is already existing and has sufficient yield, it remains the preferred alternative.  
Alternative roadway alignments were considered during the initial construction of the well under the supervision of a qualified archaeologist. The proposed roadway is designed to avoid any direct impacts on the existing historic sites.
3. The impacts of the Maakua Well project on the existing Windward regional water system are positive, consistent and beneficial to the public. The regional water system improvements, of which the Maakua Well is a part, will upgrade water service for domestic and fire protection purposes. Undersized and fragmented water systems will be brought up to current water system standards and be more efficiently interconnected.

This source, as well as the associated regional system improvements, are planned for development to meet the continually increasing water demand on Oahu. The BWS goal is to integrate our sources to provide operational flexibility and reliability of water service to all customers. Water pumped from the Maakua Well would first be used to meet the needs of consumers within the Windward district. Water in excess of this need should be available for customers in other areas.

If water system improvements are not brought on-line in a timely manner to keep pace with projected population growth, regional water shortages may occur.

Detailed Analysis

Land

Conservation District Use Application, Master Application Form & Supplement and Section 2.2

The existing well is located on State owned land under the jurisdiction of the Division of Forestry, (DOF), of the Department of Land and Natural Resources, (DLNR). The land acquisition process is still on-going and is separate and subsequent to the EA. The process involves a request by the BWS to the State to convey the land and any easements by Executive Order to the BWS. A subdivision application will then be submitted to the Department of Land Utilization for their review and approval. The BWS land acquisition process is to request the land in fee rather than lease.

The change of jurisdiction over the parcel involved in the Maakua Well development is standard BWS procedure and there should be no significant impact to DOF operations in the area. There are no implications to the County General Plan Preservation Designation. The land use and development standards for projects within State Designated Conservation Districts and County P-1 Restricted Preservation Districts are governed by DLNR and not the City and County of Honolulu Land Use Ordinance.



Mr. David L. Martin  
Page 3  
October 8, 1993

WAIKI

Section 2.3

The current average day water demand for the Hauula 180-foot water system is 0.6 Million Gallons per Day, which extends from Punaluu to Kokololio Stream in Hauula.

We do not anticipate any adverse effect on the Hauula water system as regional water system improvements are constructed. Water from the proposed source would first be used to meet the needs of consumers in the Windward district extending from Hauula to Waimanalo. Water in excess of this need would be available for consumers in other areas.

Section 5.7

We submitted applications for a Water Use Permit and a Pump Installation Permit in September 1993, to the Commission on Water Resource Management, (CWRM), as required by the State Water Code and will fully comply with their requirements.

Section 4.3.1

We note that instream flow standards do regulate groundwater development. However, stream monitoring during test pumping was not conducted because there was no stream flow in the vicinity of the well. Maakua Stream is an intermittent stream in the lower reaches and only flows during periods of high rainfall in the form of runoff. The water elevation within the well is approximately 100-feet below the stream bed elevation in the vicinity of the well site, therefore, well pumpages will not affect stream flow.

Exploratory well test pumping near flowing streams is usually conducted and monitored during dry weather periods to accurately assess the effects on stream flow. The U.S. Geological Survey and the CWRM along with the BWS, is in the process of establishing a standard aquifer test pump protocol to estimate surface



Mr. David L. Martin  
Page 4  
October 8, 1993

water impacts. Once finalized, the test pumping protocol will be included in future exploratory well EA's. The significance of stream flow monitoring was appropriately addressed prior to and during test pumping of the exploratory well at Maakua; therefore, at this phase of the well's development, the suggestion that further review of the information is needed, does not warrant a supplemental EIS.

Socio-Economic

Section 3.9 and 4.8

Questions of County-State development agreements and compensation from the disposition of public land trust assets are not pertinent to the primary intent of the EIS process and, therefore, were not specifically addressed. As previously stated, discussions with DLNR and the Department of Hawaiian Home Lands regarding the reservation of water as it relates to specific water resource development sites are anticipated.

Alternatives

Sections 5.3 and 5.4

Alternative sites were considered prior to the exploratory well construction. The main criteria were sufficient quality and yield, cost, land availability, topography, and affected environment. Because of the scarcity of developable groundwater sources, alternative sites may offer future groundwater development opportunities and are usually considered in addition, rather than as alternatives to, the BWS well development program. However, as previously stated, since this well is already existing, it remains the preferred alternative.

Conservation of existing supplies to extend existing water usage is an on-going program of the BWS. Our active water conservation program utilizes a variety of methods including public education, inverted residential water rates, leak detection, low flow plumbing fixtures, audits, drought tolerant plants, dual water





Mr. David L. Martin  
Page 5  
October 8, 1993

systems and water-use restriction plans. Water conservation is not a substitute solution for the timely development of high-quality groundwater resources which is still the most economical source for meeting increasing water demands on Oahu.

Cultural Resources

Sections I.H, 3.8, 4.7, and Appendix II

We acknowledge the access road is adjacent to two archaeological sites which are significant in terms of historic and cultural value. We clarify that one site (3394) will be avoided completely, and the portion of the other site (4227), which is not bisected by the existing hiking trail/access road, will also be avoided.

Alternative roadway alignments were considered during the initial construction of the well, where topography and historic sites were the main concerns. A qualified archaeologist monitored all site grading work. The proposed roadway is designed to avoid any direct impacts to the existing historic sites.

If there is a vestigial irrigation ditch and associated pondfield complexes, they will not be impacted because, as stated earlier, well pumpages will not affect stream flow in Maakua Stream. Restoration and reactivation of agricultural operations within the pondfield agricultural complex as a preservation alternative is not recommended by our consultant archaeologist because reconstruction of the existing walls and structures would destroy the existing nature of the archaeological sites. The State Historic Preservation Division (SHPD) is requiring preservation of these sites as-is.

We are finalizing a contract with Social Research Systems Co-op to provide all archaeological services for the project. In coordination with the SHPD, a mitigation plan will be developed including mapping, limited data recovery, historical research, an inventory survey of any unrecorded historic features, monitoring of road grading and pipeline trenching activities, flagging of historic sites and education of construction crews about the significance of these sites. We will also be discussing a long-term plan for monitoring and preservation of site-3394.



Mr. David L. Martin  
Page 6  
October 8, 1993

Summary

We feel the environmental issues, such as cultural resources and stream biota, relating to the development of this project, are site specific and adequately addressed in the final environmental assessment. Water rights and water allocation issues and test pumping protocol, are being addressed by the BWS in other more appropriate avenues, such as land acquisition and in departmental discussions. Other planning studies are addressing the viability of alternative water sources along a cost/benefit analysis. We, therefore, conclude that a supplement to our 1988 Windward Regional Environmental Impact Statement is not necessary for this project.

If you have any questions, please contact Roy Doi at 527-5235.

Very truly yours,

KAZU HAYASHIDA  
Manager and Chief Engineer

cc: Ogden Environmental, Inc.



# University of Hawaii at Manoa

Environmental Center  
A Unit of Water Resources Research Center  
Crawford 317 - 2350 Campus Road - Honolulu, Hawaii 96822  
Telephone: (808) 958-7381

May 7, 1993  
EA:00026

Mr. Bert Kuloaka  
Board of Water Supply  
City and County of Honolulu  
630 South Beretania Street  
Honolulu, Hawaii 96843

Dear Mr. Kuloaka:

## Draft Environmental Assessment (DEA) Maakua Well Project Koolauloa, Oahu

The Board of Water Supply (BWS) proposes to develop a permanent water well at the site of the existing exploratory well in Maakua Valley, maunaloa of Hauula town. This project is part of the on-going BWS program to develop water resources to meet increasing needs due to population expansion. Maakua Well is expected to contribute up to 1.0 million gallons per day to the Windward Oahu Regional Water System. The proposed project involves installing a well pump and pad, building a pump control station, widening and paving an existing construction access road, and installing approximately 4,000 linear feet of pipeline along the access road alignment. The well site is located on State-owned land and is in the conservation district. Estimated project duration is 360 consecutive calendar days and estimated project cost is \$2.1 million.

The Environmental Center has reviewed this document with the assistance of David Penn, Geography, and B. Alex Butaro of the Environmental Center.

### Master Application Form (pages 2-4)

The EA states that "the BWS is requesting a subdivision to remove the project from the Division of Forestry's jurisdiction" (page 2).

- 1) Under what authority does the BWS request a "subdivision"?
- 2) What implications are entailed by the removal of the Division of Forestry's (DOF) jurisdiction?

Mr. Bert Kuloaka  
May 7, 1993  
Page 2

- 3) Do any problems arise from DOF jurisdiction?
- 4) What are the implications of County General Plan Preservation (P-1) Designation?

### CDUA SUPPLEMENT

#### Section I.G

What is State land title status?

#### Section I.H

The EA states that the access road will bisect Site 50-80-05-4227 (appears to be an agricultural site) in two places, but the statement is also made that "sites can be avoided during construction" (page S-2). These ideas seem contradictory because if the road already bisects the sites, how can future road work avoid archaeology both below and adjacent to the existing road?

### Required Permits and Approvals, Section S.7 (page S-2)

"Permit to Withdraw Water from a Ground Water Control Area" (page S-2) has not been a DLNR permitting process since 1987, when the Ground Water Control Act was repealed in favor of the State Water Code. According to the State Water Code, well construction and pump installation permits from the Commission on Water Resource Management are required.

- 1) Does this well fall under the permitting provisions dictated by the State Water Code.
- 2) To what extent will compliance to the permitting provisions be carried out?

### Introduction (page 1-1)

The 1988 BWS Final Environmental Impact Statement (EIS) for Windward Oahu Regional Water System Improvements discussed the potential need for Supplemental EIS for individual components of the Regional Water System Improvements. In light of the dynamic and rapidly changing nature of legislative, regulatory, political, and socio-economic contextual frameworks, this EA as well as subsequent DEAs for these components should be carefully examined for the need to complete Supplemental EIS's in order to provide

Mr. Bert Kuiuoka  
May 7, 1993  
Page 3

thorough and up to date documentation and to enable an accurate assessment of cumulative impacts.

**Project Location, Section 2.2 (page 2-1)**

What is state land title status?

**Project Description, Section 2.3 (page 2-1)**

- 1) What is the quantity of demand in the Haunala area that will be primarily served by the proposed well?
- 2) How might this change as additional regional water system improvement components are brought on-line?

**Project Cost, Section 2.4 (page 2-6)**

How is the estimated total project cost allocated among project components?

**Socio-Economics, Section 3.9 (page 3-6)**

When surface water is harvested from State lands, the State issues water licenses and collects fees for this harvest. Thirty percent of these revenues go to the Hawaiian Homes Commission, and 20 percent of the remaining revenues go to the Office of Hawaiian Affairs. The fact that so similar compensation is paid for extraction of groundwater underlying State lands seems inequitable. This has a severe impact upon Native Hawaiian beneficiaries of the Hawaiian Homes Commission Act and the Public Land Trusts, who see mismanagement and erosion of their trust assets at every turn. Details of subdivision plans and other land use arrangements between the BWS and the Board of Land and Natural Resources (BLNR) should be presented in the DEA in order to fairly identify, assess, and evaluate these impacts.

**Surface Water, Section 4.3.1 (page 4-2)**

Our reviewers note that the statement, "Although instream flow standards do not regulate ground water development, the BWS will voluntarily comply (BWS 1988)", is probably dated and incorrect. Presently, changes to instream flow resulting from groundwater development require approval of the Water Commission, thus instream flow standards do regulate ground water management.

Mr. Bert Kuiuoka  
May 7, 1993  
Page 4

USGS District Chief William Meyer stated in recent Water Commission meetings, that the most important part of monitoring instream flow effects of groundwater development is to create mutually agreeable monitoring and analysis protocol prior to implementing project construction and monitoring. Discussion of planned monitoring protocol would have been helpful in the DEA. The importance of this information may warrant issuance of a Supplemental EIS, where such critical information may be more adequately addressed and comprehensively reviewed.

**Ground Water, Section 4.3.2 (page 4-3)**

The statement, "Under current law, the State can ultimately control production and use of ground water by designating ground water control areas" (page 4-3), is again, incorrect and most likely dated. The current proper terminology is "water management area," and the specific governing body is presently the Water Commission.

**Archaeological Site Evaluation and Impact Assessment, Appendix II (page 1)**

The statements in this section and throughout Appendix II that "access road construction would have no direct adverse impact on the site" [50-80-05-4227] are contradicted by the statements that say "the well access road is known to...direct archaeological site 50-80-05-4227" (page 1). How is this contradiction reconciled?

**Cultural Resources, Section 3.8 (page 3-5)**

The possible presence of a vestigial irrigation ditch and associated pondfield complexes previously drawing water from Maunua Stream deserves closer attention, especially since there may be groundwater impacts on streamflow sources of ditch water. We are concerned that until the locations of ditch intake from the stream and well site are known, it is difficult to assess the potential impacts to future irrigation potential that exists.

**Cultural Resources, Section 4.7 (pages 4-5 thru 4-6)**

The DEA states that "a retaining wall is to be constructed adjacent to Site 3394 and, where necessary for slope stabilization at other locations along the alignment" (page 4-6). Our reviewers note that such structures may destroy the cultural and archaeological integrity of interrelated sites in this area, and the proposed constructions may be entirely incompatible with existing features. What criteria were used to determine whether the proposed structures are compatible with the existing ones?

With increasing awareness of Hawaiian entitlements to public lands, particularly those involving water resources and cultural use areas, and because of unavailability of other

Mr. Bert Kuitoka  
May 7, 1993  
Page 5

lands, there is a growing need and interest in reactivating previous cultural uses such as taro cultivation, which easily utilize pre-existing infrastructure.

Mitigation may not be the best strategy for protection of cultural resources. The EA should also assess the significance of irreparably destroying a portion of what may have been a pondfield agricultural complex. Because this complex is on unencumbered State land, it could possibly be restored and put back into operation by cultural preservationists and practitioners.

The documented cultural and historical importance of the area suggests that mitigative alternatives other than archaeological data recovery and interpretation be considered. The DEA should have addressed alternatives which achieve preservation in place, site protection, site restoration, and reactivation of cultural uses.

Socio-Economics, Section 4.6 (page 4-6)

The assessment of socioeconomic impacts should have addressed questions of county-State development agreements and compensation from disposition of public land trust assets.

Alternate Sites, Section 5.3 (page 5-1)

Adequate comparative assessment of alternative sites cannot be accomplished with the limited information presented in this document. At a minimum, a matrix delineating the advantages and disadvantages of each alternative site should be included. This information should include the listed criteria of expected yield, remoteness, presence of endangered species, archaeological impacts and land availability.

Alternate Sources, Section 5.4 (page 5-1)

Conservation of existing supplies and reductions in existing use are two primary alternatives which appear in many water source development assessments and which should have been addressed in this DEA. It may be appropriate to deal with this and the previous issue (Section 5.3) even more comprehensively than we have suggested, possibly within the context of a Supplemental EIS, where more information may enable an accurate cost/benefit assessment of all the alternatives.

Cumulative Impacts

This DEA mentions that the proposed project is part of the Windward Oahu Regional Water System, yet does not expound on their interrelationship and the extent to which this project participates in the cumulative impacts of the Windward Oahu Regional

Mr. Bert Kuitoka  
May 7, 1993  
Page 6

Water System. To what extent and in what ways does this project contribute and interrelate to the System Improvements?

Cumulative impacts complicated by archaeological and socio-economic concerns demand much more in-depth assessment and evaluation, and may warrant the preparation of a Supplemental EIS to better enable assessment of environmental impacts from a regional perspective, especially because water rights and water allocation issues have become much more complex and controversial since 1988.

SUMMARY

The scope and depth of environmental issues relating to development of this project warrant more comprehensive assessment than was provided in this DEA. Consequently, a Supplemental EIS should be issued pursuant to Chapter 343 and Title 11, Chapter 200 EIS Rules. More rigorous discussion of potential impacts and mitigative strategies for cumulative impacts, cultural resources, socio-economics, and water rights/beneficiaries should be included, in addition to more comprehensive disclosure of potential alternatives and water monitoring strategies.

Thank you for the opportunity to review this DEA and we hope our comments are helpful.

Sincerely,

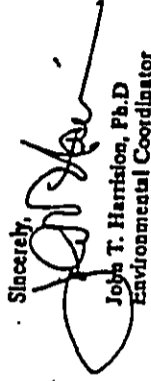

John T. Harrison, Ph.D.  
Environmental Coordinator

CC: OEQC  
Roger Fujjoka  
David Penn  
B. Alex Battaro



COPY



COPY

October 6, 1993

John T. Harrison, Ph.D.  
Environmental Center  
University of Hawaii  
Crawford 317  
2550 Campus Road  
Honolulu, Hawaii 96822

Dear Dr. Harrison:

Subject: Your Letter of May 7, 1993 Regarding the Draft Environmental Assessment (DEA) for the Proposed Maakua Well Project. TMK: 5-4-05: 1, Haoula, Oahu

Thank you for your comments to the Maakua Well project. We have revised the text of the DEA to address your specific comments where appropriate and provide the following response to your major concerns:

**Land**

Conservation District Use Application, Master Application Form & Supplement and Section 2.2

The State, by Executive Order, grants the Board of Water Supply (BWS), the authority to request a subdivision. The existing well is located on State owned land under the jurisdiction of the Division of Forestry (DOF) of the Department of Land and Natural Resources (DLNR). The land acquisition process is still ongoing and is separate and subsequent to the DEA. The process involves a request by the BWS to the State to convey the land and any easements by Executive Order to the BWS. A subdivision application will then be submitted to the Department of Land Utilization for their review and approval. The BWS land acquisition process is to request the land in fee rather than lease.

The change of jurisdiction over the land parcel involved in the Maakua Well development is standard BWS procedure and there should be no significant impact to DOF operations in the area. There are no implications to the County General Plan Preservation Designation. The land use and development standards for projects within State Designated Conservation Districts and County P-1 Restricted Preservation Districts are governed by DLNR and not the City and County of Honolulu Land Use Ordinance.

John T. Harrison, Ph.D.  
Page 2  
October 6, 1993

**Waiahi**

Section 2.3

The current average day water demand for the Haoula 180' water system is 0.6 million gallons per day, which extends from Punaluu to Kokololio Stream in Haoula.

We do not anticipate any significant effect on the Haoula water system as regional water system improvements are constructed. Water from the proposed source would first be used to meet the needs of consumers in the Windward district extending from Haoula to Wainanalo. Water in excess of this need would be available for consumers in other areas.

Section 5.7

We submitted applications for a Water Use Permit and a Pump Installation Permit in September 1993 to the Commission on Water Resource Management (CWRM), as required by the State Water Code and will fully comply with their requirements.

Section 4.3.1

We note that instream flow standards do regulate groundwater development. However, stream monitoring, during test pumping of Maakua Well, was not conducted because there was no stream flow in the vicinity of the well. Maakua Stream is an intermittent stream in the lower reaches and only flows during periods of high rainfall in the form of runoff. The water elevation within the well is approximately 100 feet below the stream bed elevation in the vicinity of the well site, therefore, well pumpages will not affect stream flow.

Exploratory well test pumping near flowing streams is usually conducted and monitored during dry weather periods to accurately assess effects on stream flow. The U. S. Geological Survey and the CWRM along with the BWS, is in the process of establishing a standard aquifer test pump protocol to estimate surface water impacts. Once finalized, the test pumping protocol will be included in future exploratory well EAs. The significance of stream flow monitoring was



COPY

John T. Harrison, Ph.D.  
Page 3  
October 6, 1993

appropriately addressed prior to and during test pumping of the exploratory well at Maakua; therefore, at this phase of the well's development, the suggestion that further review of the information is needed does not warrant a supplemental Environmental Impact Statement (EIS).

Socio-Economic

Section 3.9 and 4.8

We understand the Department of Hawaiian Home Lands will be contacting us to discuss the reservation of water as it relates to specific water resource development sites. Water developed at Maakua is also planned to meet the water demands of State projects.

Questions of County-State development agreements and compensation from the disposition of public land trust assets are not pertinent to the primary intent of the EIS process and, therefore, were not specifically addressed.

Alternatives

Sections 5.3 and 5.4

A cost/benefit assessment weighing the development of potable groundwater sources in increasingly remote areas against alternative water sources can also be discussed in separate planning studies and does not warrant the issuance of a Supplemental EIS. We have undertaken feasibility studies addressing the viability and cost effectiveness of desalination, wastewater reuse and other nonpotable water sources.

Alternative sites were considered prior to the exploratory well construction. The main criteria were sufficient quality and yield, cost, land availability, topography, and affected environment. Because of the scarcity of developable groundwater sources, alternative sites may offer future groundwater development opportunities and are usually considered in addition rather than as alternatives to the BWS well development program. However, since this well is already existing, it remains the preferred alternative.



COPY

John T. Harrison, Ph.D.  
Page 4  
October 6, 1993

Conservation of existing supplies to extend existing water usage is an ongoing program of the BWS. Our active water conservation program utilizes a variety of methods including public education, inverted residential water rates, leak detection, low flow plumbing fixtures, audits, drought tolerant plants, dual water systems and water-use restriction plans. We feel water conservation cannot be a substitute solution for the timely development of high-quality groundwater resources which insures the available safe drinking water supply keeps pace with projected population growth.

Cultural Resources

Sections 1.H, Appendix II, 3.8 and 4.7

We acknowledge the access road is adjacent to two archaeological sites which are significant in terms of historic and cultural value. We clarify that one site (3394) will be avoided completely, and the portion of the other site (4227), which is not bisected by the existing hiking trail/access road, will also be avoided.

Alternative roadway alignments were considered during the initial construction of the well, where topography and historic sites were the main concerns. The proposed roadway is designed to avoid any direct impacts to the existing historic sites.

Cultural site avoidance and structural support were the main criteria in the retaining wall design. The use of retaining walls along the roadway serve to stabilize and reduce the affected area. To maintain adequate buffer zones for historic sites, sections of the roadway were relocated into the existing embankment necessitating the use of retaining walls. As much as possible, stabilizing structures will be compatible with the environmental setting. Standard embankments sloped at a 2:1 ratio, which create a wider corridor, will be used in most areas if site conditions allow. Concrete retaining walls will only be used in confined areas where structural support is necessary. Drainage control structures along the roadway will further minimize erosional impacts to the historic sites.



COPY

John T. Harrison, Ph.D.  
Page 5  
October 6, 1993

Restoration and reactivation of agricultural operations within the pondfield agricultural complex is not recommended by our consultant archaeologist as a preservation alternative because reconstruction of the existing walls and structures would destroy the existing nature of the archaeological sites. State Historic Preservation Division (SHPD) is requiring preservation of these sites as is.

We are finalizing a contract with Social Research Systems Co-op to provide all archaeological services for the project. In coordination with the SHPD, a mitigation plan will be developed including mapping, limited data recovery, historical research, an inventory survey of any unrecorded historic features, monitoring of road grading and pipeline trenching activities, flagging of historic sites and education of construction crews about the significance of these sites. We will also be discussing a long-term plan for monitoring and preservation of site 3394.

Cumulative Impacts

The impacts of the Maakua Well project on the existing Windward regional water system are positive, consistent and beneficial to the public. The regional water system improvements, of which the Maakua Well is a part, will upgrade water service for domestic and fire protection purposes. Undersized and fragmented water systems will be brought up to current water system standards and be more efficiently interconnected.

This source, as well as the associated regional system improvements, are planned for development to meet the continually increasing water demand on Oahu. The BWS goal is to integrate our sources to provide operational flexibility and reliability of water service to all customers. Water pumped from the Maakua Well would first be used to meet the needs of water users within the Windward district. Water in excess of this need should be available for customers in other areas.

Summary

We feel the environmental issues, such as cultural resources and stream biota, relating to the development of this project, are site specific and adequately addressed in the final environmental assessment. Water rights and water allocation issues and test pumping protocol are being addressed by the BWS in other more appropriate avenues, such as



COPY

John T. Harrison, Ph.D.  
Page 6  
October 6, 1993

the land acquisition process and in departmental discussions. Other planning studies are addressing the viability of alternative water sources along a cost/benefit analysis. We, therefore, conclude that a supplement to our 1988 Windward Regional Environmental Impact Statement is not necessary for this project.

If you have any questions, please contact Roy Doi at 527-5235.

Very truly yours,

KAZU HAYASHIDA  
Manager and Chief Engineer

cc: Ogden Environmental

**APPENDIX IV**

**COMMENTS AND RESPONSES TO PUBLIC REVIEW OF  
DRAFT AMENDED EA  
MAAKUA WELL PROJECT**





Page Three  
R. Sato

If you have any questions please call Tom Dye at 587-0014.

Aloha,

  
DON HIBBARD, Administrator and  
State Historic Preservation Officer

TD:smf

cc. Sam Lemmo, Land Division

BOARD OF WATER SUPPLY

CITY AND COUNTY OF HONOLULU  
630 SOUTH BERETANIA STREET  
HONOLULU, HAWAII 96813  
PHONE (808) 527-6180  
FAX (808) 533-2714



May 15, 1996

JEREMY HARRIS, Mayor  
WALTER D. WATSON, JR., Chairman  
MAURICE H. YAMASATO, Vice Chairman  
KAIU HAYASHIDA  
KEISSA Y. LUM  
FOREST C. MURPHY  
ALMETHIE SPRAGUE  
BARBARA KUM STANTON  
RAYMOND H. SATO  
Manager and Chief Engineer

Mr. Don Hibbard, Administrator  
State Historic Preservation Division  
Department of Land and Natural Resources  
State of Hawaii  
33 South King Street, 6th Floor  
Honolulu, Hawaii 96813

Dear Mr. Hibbard:

Subject: Your Letter of March 4, 1996 Regarding the Archaeological Inventory Survey and Mitigation Plan for the Board of Water Supply's Proposed Maakua Well Control Station and Access Road Project. IMK: 5-4-05: 01

Thank you for your letter regarding the archaeological inventory survey and mitigation plan for the proposed Maakua Well Control Station and Access Road project.

We acknowledge that the archaeological inventory survey and mitigation plan are not acceptable in their present form. We are in the process of selecting another archaeological consultant to address the archaeological requirements established in Condition 12 of Conservation District Use Permit OA-2636. Our new consultant will not proceed with any field work until the scope of work is approved by your staff.

If you have any questions, please contact Barry Usagawa at 527-5235.

Very truly yours,

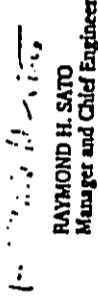
  
RAYMOND H. SATO  
Manager and Chief Engineer



STATE OF HAWAII  
DEPARTMENT OF LAND AND NATURAL RESOURCES  
DIVISION OF LAND MANAGEMENT  
P.O. BOX 621  
HONOLULU, HAWAII 96809  
MAR - 6 1996

RECEIVED  
MAY 14 1996  
DIVISION OF LAND MANAGEMENT  
P.O. BOX 621  
HONOLULU, HAWAII 96809

BOARD OF WATER SUPPLY  
CITY AND COUNTY OF HONOLULU  
630 SOUTH BERETANIA STREET  
HONOLULU, HAWAII 96843  
PHONE (808) 527-6180  
FAX (808) 533-2714



May 14, 1996

JEFFREY HARRIS, Mayor  
WALTER D. WATSON, Jr., Chairman  
MARGARET M. HANAUSS, Vice Chairman  
KAZUHIYASHIRO  
ARLENE S. Y. LUI  
FORESTIC MERRITT  
KEVIN THE SPURLOCK  
BARBARA KIM STANTON  
RAYMOND H. SATO  
Manager and Chief Engineer

Mr. Dean Uchida, Administrator  
Land Division  
Division of Land Management  
Department of Land and Natural Resources  
State of Hawaii  
P. O. Box 621  
Honolulu, Hawaii 96809

Dear Mr. Uchida:

Subject: The Oahu Land Agent's Memorandum of March 6, 1996 on the Amendment of the Conservation District Use Permit for Construction of a 10,000-Gallon Overflow Reservoir for the Proposed Maakua Well Project, TMK: 5-4-5: Pordon 1, Hauula Town, Koolauloa District, Oahu, Hawaii

We note that the Oahu District Office of Land Management has no objections to the proposed project. We have the following response to Mr. Dooling's comments:

1. Construction will be performed in accordance with the requirements of the Conservation District Use Permit, particularly, in mitigating adverse impacts to Maakua Stream and to the two recorded historic sites in the project vicinity.
2. We will apply with the Land Division for easements after the projects meters and bounds are determined and a subdivision map is prepared.
3. Construction activities will be conducted in compliance with Federal, State and County laws, statutes, and ordinances. All required permits will be obtained.

If you have any questions, please contact Barry Usagawa at 527-5235.

Very truly yours,

*Raymond H. Sato*  
RAYMOND H. SATO  
Manager and Chief Engineer

TO: Dean Uchida, Administrator  
Land Division

FROM: *John Dooling*  
John Dooling  
Oahu Land Agent

SUBJECT: Amendment of the Conservation District Use Permit for construction of a 10,000 gallon overflow reservoir for the Maakua Well Project at Hauula Town, Koolauloa, Oahu, TMK: 5-4-5:01 (BOR)

The Oahu District Office of Land Management has no objections to the subject plans provided that:

- 1.) The construction activities are specifically concurrent with the requirements of the Conservation District Use Permit, in particular those requirements that mitigate adverse effects on Maakua stream and on the two recorded historic sites in the project vicinity.
- 2.) The Board of Water Supply must apply with the Land Division for easements for the project on the State-owned subject land.
- 3.) The construction activities are in compliance with Federal, State and County laws, statutes, and ordinances and that all required permits are obtained.

CITY AND COUNTY OF HONOLULU  
PLANNING DEPARTMENT  
150 SOUTH BERETANIA STREET  
HONOLULU, HAWAII 96813

MAR 13 1 31 PM '96



CHERYL D. SOON  
CHIEF PLANNING OFFICER  
PLANNING DEPARTMENT  
150 SOUTH BERETANIA STREET  
HONOLULU, HAWAII 96813

MH 2/96-0489

March 11, 1996

Honorable Michael D. Wilson, Chairperson  
Board of Land and Natural Resources  
Department of Land and Natural Resources  
State of Hawaii  
P.O. Box 621  
Honolulu, Hawaii 96809

Dear Mr. Wilson:

Amended Conservation District Use Application  
(CDUA) No. OA-2636A for the Proposed Maakua  
Well Project, Haoula Town, Koolauloa District,  
Oahu, TMK: 5-4-5: Prr. 1

In response to your department's request of February 15, 1996, we have reviewed the subject amended CDUA/Environmental Assessment and have no objections. The proposed project is consistent with the Koolauloa Development Plan Public Facilities Map, which shows a symbol for a publicly funded well, site determined, within six years, for the proposed Maakua Well (Ordinance No. 93-35).

Should you have any questions, please contact Matthew Higashida of our staff at 527-6056.

Sincerely,

*Cheryl D. Soon*  
CHERYL D. SOON  
Chief Planning Officer

CDS:n

cc: Office of Environmental Quality Control  
Board of Water Supply

BOARD OF WATER SUPPLY

CITY AND COUNTY OF HONOLULU

630 SOUTH BERETANIA STREET

HONOLULU, HAWAII 96813

PHONE (808) 527-6100

FAX (808) 533-2714

COPY



April 26, 1996

JEREMY HARRIS, Mayor  
WALTERO WATSON, Jr., Chairman  
MAURICE H. YAMASATO, Vice Chairman  
KAZUHIYASHIDA  
MELISSA Y. LUM  
FORREST C. MURPHY  
KENNETH E. STRAUDE  
BARBARA KIM STANTON  
RAYMOND H. SATO  
Manager and Chief Engineer

TO: CHERYL D. SOON, CHIEF PLANNING OFFICER  
PLANNING DEPARTMENT

FROM: RAYMOND H. SATO, MANAGER AND CHIEF ENGINEER  
BOARD OF WATER SUPPLY

SUBJECT: YOUR MEMORANDUM OF MARCH 11, 1996 TO THE BOARD OF LAND  
AND NATURAL RESOURCES REGARDING THE CONSERVATION  
DISTRICT USE APPLICATION (CDUA) AMENDMENT OA-2636A FOR THE  
BOARD OF WATER SUPPLY'S (BWS) PROPOSED MAAKUA WELL  
PROJECT. HAUULA, KOOLAULOA, OAHU, TMK: 5-4-5: PORTION 1

Thank you for reviewing the CDUA amendment for the BWS's proposed Maakua Well project.

We acknowledge that you have no objections to the proposed amendment to construct an overflow reservoir and appurtenant facilities. We note that the proposed project is consistent with the Koolauloa Development Plan Public Facilities Map.

If you have any questions, please contact Barry Usagawa at 527-5235.

cc: Sam Lemmo (Department of Land and Natural Resources)

1111 ANA'OLI CALEMANO  
CHIEF

RECEIVED  
DIVISION OF  
LAND AND NATURAL RESOURCES

MAR 14 12 20 PM '96  
STATE OF HAWAII  
DEPARTMENT OF TRANSPORTATION  
869 PUNCHBOWL STREET  
HONOLULU, HAWAII 96813-5097

MAR 13 1996

RECEIVED  
DIVISION OF  
LAND AND NATURAL RESOURCES

DEPARTMENT OF TRANSPORTATION  
869 PUNCHBOWL STREET  
HONOLULU, HAWAII 96813-5097

**BOARD OF WATER SUPPLY**

CITY AND COUNTY OF HONOLULU

630 SOUTH BERTANHA STREET

HONOLULU, HAWAII 96813

PHONE (808) 527-6180

FAX (808) 533-2714



April 26, 1996

JEREMY HARRIS, Mayor  
WALTER O. WATSON, JR., Chairman  
LAURENCE H. YAMASATO, Vice Chairman  
KAZU HAYASHIDA  
MELISSA Y. LUI  
FOREST C. MURPHY  
KEMETHE SPRAGUE  
SUSANA KIM STANTON  
RAYMOND H. SATO  
Manager and Chief Engineer

Mr. Kazu Hayashida  
Director of Transportation  
Department of Transportation  
State of Hawaii  
869 Punchbowl Street  
Honolulu, Hawaii 96813-5097

Dear Mr. Hayashida:

Subject: Your Letter of March 13, 1996 to the Board of Land and Natural Resources  
Regarding Conservation District Use Application (CDUA) Amendment OA-2636A for  
the Board of Water Supply's (BWS) Proposed Maakua Well Project, Hanalei,  
Koolauloa, Oahu, TMK: 5-4-5: POR. 1

Thank you for your letter regarding the CDUA amendment for the BWS's proposed Maakua Well project.

We acknowledge that the proposed amendment to construct an overflow reservoir and appurtenant facilities will not impact any State highway facilities.

If you have any questions, please contact Barry Usagawa at 527-5235.

Very truly yours,

RAYMOND H. SATO  
Manager and Chief Engineer

cc: Sam Lemmo (Department of Land and Natural Resources)

TO: MICHAEL D. WILSON, CHAIRPERSON  
BOARD OF LAND AND NATURAL RESOURCES

FROM: KAZU HAYASHIDA  
DIRECTOR OF TRANSPORTATION

SUBJECT: CONSERVATION DISTRICT USE APPLICATION AMENDMENT OA-2636A,  
MAKUA WELL PROJECT (HONOLULU BOARD OF WATER SUPPLY),  
HAUULA TOWN, KOOLAULOA, OAHU, TMK: 5-4-5: POR. 1

The proposed amendment to construct an overflow reservoir and appurtenant facilities will not impact our State highway facilities.

Please note that a Highways Division permit will be required if there is to be any work within the Kamehameha Highway rights-of-way.

BENJAMIN J. CAYETANO  
Director



STATE OF HAWAII  
OFFICE OF ENVIRONMENTAL QUALITY CONTROL

230 SOUTH KING STREET  
FOURTH FLOOR  
HONOLULU, HAWAII 96813  
TELEPHONE (808) 533-4100  
FACSIMILE (808) 533-4100

April 8, 1996

The Honorable Raymond H. Sato, Manager and Chief Engineer  
Board of Water Supply  
City and County of Honolulu  
630 South Beretania Street  
Honolulu, Hawaii 96813

Dear Mr. Sato:

We submit for a response (required by Section 343-5(c), Hawaii Revised Statutes) the following comments on a January 1996, amended conservation district use application and draft environmental assessment for "Maakua Well Project, Hauula Town, Koolaha District, Oahu, TMK 5-4-5: por.1." The document was submitted by a February 15, 1996, memorandum to our office by the State of Hawaii Department of Land and Natural Resources (File No. OA-2638, Ref. OCEA-SL). Notice of availability of this draft environmental assessment was published in the March 8, 1996, and March 23, 1996, editions of the Environmental Notice.

1. Please ascertain and describe for inclusion in a final environmental assessment the land title status, if any, of the proposed parcel under Section 5 of the Admission Act. If the project involves the use of ceded lands, please consult with the Office of Hawaiian Affairs before proceeding.
2. We are concerned on the effects of the project on access to hiking trails in the area, however we find that the Board's March 23, 1993, response to Councilmember Holmes (in Appendix A) addresses our concerns.

Please submit this letter and response to the Department of Land and Natural Resources for inclusion in the final environmental assessment and notice of determination for this project. If there are any questions, please call Mr. Leslie Segundo, Environmental Health Specialist toll-free at 588-4185. Thank you for the opportunity to comment.

Sincerely,

GARY GILL  
Director

- cc: Hon. Michael D. Wilson, Chairperson, Board of Land and Natural Resources  
Mr. Barry Usagawa, Board of Water Supply  
Ms. Linda K. Delaney, Office of Hawaiian Affairs

961023

CLAY GILL  
DIRECTOR  
7/3  
11/17/96  
PE

APR 12 11 27 AM '96

BOARD OF WATER SUPPLY

CITY AND COUNTY OF HONOLULU  
630 SOUTH BERETANIA STREET  
HONOLULU, HAWAII 96813  
PHONE (808) 527 6180  
FAX (808) 533 2714



May 15, 1996

JEREMY HARRIS, Mayor  
WALTER D. WILSON, Jr., Chairman  
MURPHY H. YAMAGUCHI, Vice Chairman  
BARU HAYASHIDA  
MELISSA J. LIMA  
FORRESTIC LARSEN  
ALEXANDER SPRADUE  
BARBARA RIM STANTON  
RAYMOND H. SATO  
Manager and Chief Engineer

Mr. Gary Gill, Director  
Office of Environmental Quality Control  
State of Hawaii  
220 South King Street  
Honolulu, Hawaii 96813

Dear Mr. Gill:

Subject: Your letter of April 8, 1996 Regarding Conservation District Use Application (CDUA) Amendment OA-2638A for the Board of Water Supply's Proposed Maakua Well Project, Hauula, Koolaha District, Oahu, TMK 5-4-5: Portion 1

Thank you for your letter regarding the CDUA amendment for the Board of Water Supply's proposed Maakua Well project. We provide the following response:

1. The proposed project involves the use of ceded lands; therefore, we will consult with the Office of Hawaiian Affairs before proceeding with the project.
2. Continuous access to the hiking trails in the area will be maintained.

If you have any questions, please contact Barry Usagawa at 527-5235.

Very truly yours,

RAYMOND H. SATO  
Manager and Chief Engineer

- cc: Division of Land Management, Department of Land and Natural Resources

Pure Water... our greatest need - use it wisely

P

May 1 9 02 AM '96

961336

Mr  
Rep  
PE



STATE OF HAWAII  
OFFICE OF HAWAIIAN AFFAIRS  
711 KAPICLANI BOULEVARD, SUITE 500  
HONOLULU, HAWAII 96813-5249  
PHONE (808) 584-1885  
FAX (808) 584-1885

April 25, 1996

Mr. Raymond H. Sato  
Board of Water Supply  
City and County of Honolulu  
630 South Beretania St.  
Honolulu, HI 96813

Dear Mr. Sato:

Thank you for the opportunity to review the Amended Conservation District Use Application and Environmental Assessment (EA) for the Maakua Well Project, Haunala Town, Koolauloa District, Island of Oahu. The proposed well is part of a major development project to integrate new ground water sources to meet growing demand for drinking water in windward Oahu.

The Office of Hawaiian Affairs (OHA) has no objections to the proposed project as it apparently bears no adverse impacts on adjacent lands nor upon existing flora or fauna and no known archaeological remains exist in the area.

According to the preparers, the land for the project belongs to the State of Hawaii (page S-2, EA Report). OHA wishes to clearly state that if the project involves the use of ceded lands, further implementation plans must be pursued in close consultation with OHA directives. Please contact me, or Linda K. Delaney, LNR Division Officer (594-1938), or Luis A. Manrique (594-1755), should you have any questions on this matter.

Sincerely yours,

*Linda M. Colburn*  
Linda M. Colburn  
Administrator

LN:lm

BOARD OF WATER SUPPLY

CITY AND COUNTY OF HONOLULU  
630 SOUTH BERETANIA STREET  
HONOLULU, HAWAII 96813  
PHONE (808) 527-6180  
FAX (808) 533-2714

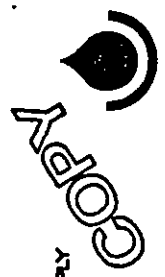

May 23, 1996

Mrs. Linda M. Colburn, Administrator  
Office of Hawaiian Affairs  
711 Kapiolani Boulevard, Suite 500  
Honolulu, Hawaii 96813-5249

Dear Mrs. Colburn:

Subject: Your Letter of April 25, 1996 Regarding the Board of Water Supply's (BWS) Amended Conservation District Use Application (CDUA) and Environmental Assessment (EA) for the Proposed Maakua Well Project, Haunala, Koolauloa, Oahu. TMK: 5-4-5: Pot. 1

Thank you for your letter regarding the BWS's amended CDUA and EA for the proposed Maakua Well project.

We provide the following comments to your concerns:

1. We acknowledge that you have no objections to the proposed project as it should not adversely impact any adjacent lands, historic sites, or flora or fauna in the area.
2. We understand the proposed project is within ceded lands; therefore, further implementation plans will be coordinated with the Office of Hawaiian Affairs.

If you have any questions, please contact Barry Usagawa at 527-5235.

Very truly yours,

*Raymond H. Sato*  
RAYMOND H. SATO  
Manager and Chief Engineer

cc: Sam Lemmo  
(Department of Land and Natural Resources, Division of Land Management)

JEREMY HARRIS, Mayor  
WALTER D. WATSON, JR., Chairman  
MAURICE H. YAMASATO, Vice Chairman  
KAZU HAYASHIDA  
MELISSA J. LIU  
FORREST C. MURPHY  
KEVIN M. SPRAGUE  
BARBARA RIM STANTON  
RAYMOND H. SATO  
Manager and Chief Engineer

RECEIVED  
DIVISION OF  
LAND & NATURAL RESOURCES  
MAY 3 1 50 PM '96



STATE OF HAWAII  
DEPARTMENT OF HEALTH  
1001 KALANIANA'OLA  
HONOLULU, HAWAII 96801

PLN-44/96

RECEIVED  
DIVISION OF  
LAND & NATURAL RESOURCES  
MAY 3 1 50 PM '96

April 25, 1996

92-352C/epo

TO: The Honorable Michael Wilson, Chairperson  
Department of Land and Natural Resources

FROM: Lawrence Mike *Lawrence Mike*  
Director of Health

SUBJECT: CONSERVATION DISTRICT USE APPLICATION

Applicant: City & County of Honolulu  
Board of Water Supply  
File No: OA-2636 A  
Request: 10,000 Gallon Overflow Reservoir at  
Maakua Well Site  
Location: Haunala, Oahu  
THK: 5-5-05; por. of 1

Thank you for allowing us to review and comment on the subject request. We have the following comments to offer:

1. The Maakua well is within an aquifer area that is characterized with groundwater that is fresh, but highly vulnerable to contamination.
2. There are concerns with the potential contamination that the neighboring cesspools could impose upon the quality of the basal groundwater. Though current Department of Health water quality data from the nearest drinking water well, Haunala Well No. 3655-01, have not detected high levels of nitrate, we would like to encourage the use of caution in the opening and use of this well.
3. We would like to recommend the use of Best Management Practices in maintaining the present quality of the basal groundwater.

If you have any questions, please call Mr. Russell Kumabe of the Environmental Planning Office at 586-7550.

c: EPO (Groundwater Protection)

RECEIVED  
MAY 13 12:14

BOARD OF WATER SUPPLY

CITY AND COUNTY OF HONOLULU  
630 SOUTH BERTINARA STREET  
HONOLULU HAWAII 96843  
PHONE (808) 537 6180  
FAX (808) 533 2714



May 31, 1996

Mr. Michael Wilson, Chairperson  
Commission on Water Resource Management  
Department of Land and Natural Resources  
State of Hawaii  
P.O. Box 621  
Honolulu, Hawaii 96809

Dear Mr. Wilson:

Subject: The Director of Health's Memorandum of April 25, 1996 on the Conservation District Use Application OA-2636A for the Proposed 10,000 Gallon Overflow Reservoir at the Maakua Well Site, THK: 5-4-05; Portion 01, Haunala, Oahu, Hawaii

We have the following response to Dr. Mike's comments:

1. We understand that the Maakua Well is within an aquifer area that is characterized with groundwater that is fresh, but vulnerable to contamination.
2. Contamination of the Maakua Well from deep percolation of cesspools from residential areas along Haunala Homestead Road is unlikely, since the well is almost a quarter mile up-gradient from the nearest residence. Although current Department of Health water quality data indicates that high levels of nitrate have not been detected from the nearest drinking water well, Haunala Well No. 3655-01, standard sanitary procedures will be followed in the construction and use of the Maakua Well. The Board of Water Supply (BWS) will monitor the quality of withdrawn water to ensure compliance with applicable State and Federal drinking water regulations.
3. Best Management Practices will be used in maintaining the present quality of the basal groundwater. The well casing extends to a depth of 215 feet below ground level and is grouted to the surface, thereby protecting the aquifer from contamination by a surface source. The watershed providing source water to this well is within the No-Pass Zone where inappropriate land uses are restricted. The BWS will measure salinity in the production well for seawater intrusion into the basal aquifer. If salinity trends indicate salt water intrusion, well pumpage will be decreased accordingly.

If you have any questions, please contact Barry Usagawa at 527-5235.

Very truly yours,

*Barry Usagawa*  
BARRY USAGAWA  
Manager and Chief Engineer

Pure Water... our greatest need - see it study