

1998 - Oahu - FEIS -
Waimanalo Wastewater

FILE COPY

~~XXXXXXXXXX~~
1-8-99

Final Supplemental Environmental Impact Statement

**Waimanalo Wastewater Facilities Plan
Koolaupoko, Oahu, Hawaii**

**Proposing Agency:
Department of Design and Construction
City and County of Honolulu
650 South King Street
Honolulu, Hawaii 96813**

**Prepared By:
Hawaii Pacific Engineers, Inc.**

**Contract No. F37195(A)
December 28, 1998**

Department of Design and Construction
City and County of Honolulu

FINAL SUPPLEMENTAL ENVIRONMENTAL IMPACT STATEMENT
FOR
WAIMANALO WASTEWATER FACILITIES PLAN

Koolaupoko, Oahu, Hawaii
TMK: 4-1

December 28, 1998

THIS ENVIRONMENTAL DOCUMENT IS SUBMITTED
PURSUANT TO CHAPTER 343, HRS

PROPOSING AGENCY: Department of Design and Construction
City and County of Honolulu
650 South King Street
Honolulu, Hawaii 96813

ACCEPTING AUTHORITY: Governor
State of Hawaii

RESPONSIBLE OFFICIAL: Randall K. Fujiki, Director

*This document has been prepared under my direction
pursuant to the requirements of Chapter 343, HRS:*



FOR Randall K. Fujiki, Director

DEC 24 1998

Date

PREPARED BY: Hawaii Pacific Engineers, Inc.
1132 Bishop Street, Suite 1003
Honolulu, Hawaii 96813-2830

PREFACE

The City and County of Honolulu Department of Design and Construction (formerly Department of Wastewater Management) is in the process of updating the Waimanalo Wastewater Facilities Plan. The facilities plan describes the basis and recommendations for collection system and treatment facility improvements to meet the wastewater management needs of the Waimanalo community to the year 2020.

The prefinal submittal "Waimanalo Wastewater Facilities Plan" report, dated April 30, 1997, updates and supersedes the previous "Waimanalo Facility Plan," dated January 1984. A final facilities plan report will be prepared based on input and comments received during the environmental review process. This *Final Supplemental Environmental Impact Statement (FSEIS)* updates the "Revised Environmental Impact Statement, Waimanalo Wastewater Facilities" previously prepared in January 1984 and accepted by the Governor on March 13, 1984.

Proposed offsite facilities involving reuse of effluent for irrigation of farm lots were previously addressed in the "Final Watershed Plan and Environmental Impact Statement, Waimanalo Watershed," December 1981, prepared by the U.S. Department of Agriculture Soil Conservation Service (SCS). Federal funding through the Natural Resources Conservation Service (formerly SCS) is anticipated to be available for the construction of the reclaimed water storage and transmission facilities servicing the farm lots. This *FSEIS* provides updated information on the plans to utilize treated effluent for irrigation.

Many of the recommendations in the facilities plan would normally be exempt from the Chapter 343 environmental review process because they involve routine repair and upgrade work having minimal impacts. Examples of exempt actions include rehabilitation of existing sewers, and replacement or minor upgrade of pumping and treatment process equipment. These actions are addressed in this document largely because they are an integral part of the wastewater facilities plan recommendations and collectively contribute substantially to the overall financial impacts.

The City and County of Honolulu has recently undergone a major reorganization of its staff. Prior to the reorganization, the Department of Wastewater Management was responsible for the Waimanalo Wastewater Facilities Plan project and the preparation and distribution of the SEIS preparation notice. Following the reorganization, the responsibility for the facilities plan project and the completion of the environmental review process has been transferred to the newly created Department of Design and Construction (DDC). The Department of Wastewater Management (WWM) has been reorganized and is now called the Department of Environmental Services (ENV). This document makes reference to both the DDC and ENV as the DDC is responsible for planning and design of the wastewater facilities and the ENV is responsible for operating and maintaining the facilities.

This FSEIS incorporates revisions to the Draft Supplemental Environmental Impact Statement (DSEIS). The revisions are italicized in this FSEIS to comply with the Chapter 343 requirement that the FSEIS be written in a format which allows the reader to easily distinguish changes made to the text of the DSEIS.

TABLE OF CONTENTS

	Page No.
SUMMARY	
DESCRIPTION OF PROPOSED ACTION	S-1
SIGNIFICANT BENEFICIAL AND ADVERSE IMPACTS	S-1
Water Quality and Public Health Protection	S-1
Economic, Land Use, Social and Other Long Term Impacts	S-2
Short Term Impacts	S-3
PROPOSED MITIGATION MEASURES	S-3
ALTERNATIVES CONSIDERED	S-3
UNRESOLVED ISSUES	S-4
COMPATIBILITY WITH LAND USE PLANS AND POLICIES	S-5
LISTING OF PERMITS OR APPROVALS	S-6
CHAPTER 1 - PROPOSED ACTION	
PURPOSE AND NEED FOR PROPOSED ACTION	1-1
Background and Historic Perspective	1-1
Need for Upgrade and Expansion of Wastewater Facilities	1-3
STATEMENT OF OBJECTIVES	1-4
DESCRIPTION OF PROPOSED ACTION	1-4
Sewer Rehabilitation	1-7
Sewering of Existing Development	1-7
Kahawai Stream Wastewater Pump Station Upgrade	1-7
Waimanalo Wastewater Treatment Plant Upgrade	1-8
USE OF PUBLIC FUNDS AND LANDS	1-10
Funding	1-10
Land	1-14
PHASING AND TIMING OF ACTION	1-14
SUMMARY OF DIFFERENCES BETWEEN THE PROPOSED ACTIONS OF THE 1984 AND CURRENT WASTEWATER PLANS	1-14

TABLE OF CONTENTS (Continued)	Page No.
CHAPTER 2 - ALTERNATIVES TO THE PROPOSED ACTION	
INTRODUCTION	2-1
WASTEWATER COLLECTION SYSTEM ALTERNATIVES	2-1
Evaluation of Collection System Capacity Alternatives	2-2
Evaluation of Collection System Service Area Expansion Alternatives	2-6
WASTEWATER TREATMENT PLANT ALTERNATIVES	2-13
Evaluation of Biological Treatment Alternatives	2-13
Evaluation of Effluent Disinfection Alternatives	2-25
Evaluation of Effluent Disposal Alternatives	2-27
Evaluation of Sludge Disposal Alternatives	2-39
CHAPTER 3 - ENVIRONMENTAL SETTING	
INTRODUCTION	3-1
CHARACTERISTICS OF THE PHYSICAL ENVIRONMENT	3-2
Climate	3-2
Topography	3-2
Geology and Soils	3-7
Groundwater	3-12
Streams	3-21
Wetlands	3-31
Coastal Waters	3-32
Natural Hazards	3-39
BIOLOGICAL ENVIRONMENT	3-40
Terrestrial and Freshwater Biota	3-40
Marine Biota	3-42
CHARACTERISTICS OF THE DEVELOPED COMMUNITY ENVIRONMENT	3-43
Historical Overview	3-44
Economic and Social Profile	3-45
Land Ownership	3-46
Population and Projected Growth	3-47
Water Supply	3-64
Wastewater Facilities	3-66
Drainage Facilities and Flood Control	3-78
Solid Waste Disposal/Reuse	3-80
Transportation Facilities	3-82
Electrical Utilities	3-82
Recreational Facilities	3-82
Historic Sites and Archeological Resources	3-84
Air Quality	3-85
Noise Levels	3-88

TABLE OF CONTENTS (Continued)

Page No.

CHAPTER 4 - RELATIONSHIP TO LAND USE PLANS, POLICIES AND CONTROLS

GENERAL 4-1

EVALUATION OF STATE LAND USE PLANS AND POLICIES 4-1

 Land Use Classifications 4-1

 State Land Use Planning/Development Practices and Policies 4-4

 Agricultural Lands of Importance (ALISH) 4-4

 Coastal Zone Management 4-6

 State of Hawaii Department of Health, Water Quality Management Plan
 for the City and County of Honolulu, (208 Plan) 4-6

EVALUATION OF CITY LAND USE PLANS AND POLICIES 4-7

 Oahu General Plan 4-7

 Koolaupoko Development Plan 4-8

 Zoning 4-11

 Special Management Area 4-11

EVALUATION OF FEDERAL LAND USE PLANS AND POLICIES 4-14

SUMMARY OF THE REQUIRED APPROVALS 4-14

CHAPTER 5 - PROBABLE IMPACTS AND MITIGATION MEASURES

INTRODUCTION 5-1

LONG TERM IMPACTS 5-1

 Water Quality and Public Health Protection 5-1

 Land Use, Development and Social Impacts 5-25

 Land Alteration, Aesthetics and Impacts to Surrounding Community 5-26

 Noise Impacts 5-27

 Air Quality Impacts 5-27

 Solid Waste Disposal Impacts 5-30

 Energy Consumption Impacts 5-31

 Economic Impacts 5-31

 Flooding Impacts 5-33

 Natural and Human Environmental Impacts on the Project 5-35

SHORT TERM IMPACTS 5-35

 Land Alteration and Aesthetic Impacts 5-35

 Flora and Fauna Impacts 5-36

 Archeology and Historical Sites Impacts 5-36

 Water Quality Impacts 5-37

 Noise and Air Quality Impacts 5-39

 Traffic and Public Safety Impacts 5-40

 Impacts to Utilities 5-41

 Economic Impacts 5-42

STATE REVOLVING FUND (SRF) FEDERAL "CROSS CUTTING" AUTHORITIES 5-42

TABLE OF CONTENTS (Continued)

Page No.

CHAPTER 6 - RELATIONSHIP BETWEEN LOCAL SHORT-TERM USES OF THE ENVIRONMENT AND THE MAINTENANCE AND ENHANCEMENT OF LONG-TERM PRODUCTIVITY

CHAPTER 7 - IRREVERSIBLE AND IRRETRIEVABLE COMMITMENTS OF RESOURCES

CHAPTER 8 - UNAVOIDABLE ADVERSE ENVIRONMENTAL IMPACTS

WATER QUALITY AND PUBLIC HEALTH PROTECTION IMPACTS 8-1

ENERGY CONSUMPTION IMPACTS 8-2

FINANCIAL IMPACTS 8-2

GROWTH IMPACTS 8-2

LAND USE IMPACTS 8-2

CONSTRUCTION IMPACTS 8-2

CHAPTER 9 - SUMMARY OF UNRESOLVED ISSUES

FUNDING 9-1

CONSTRUCTION TIMETABLE 9-1

KOOLAUPOKO DEVELOPMENT PLAN REVISIONS 9-1

FLOODING 9-1

WATER QUALITY IMPACTS FROM INDIVIDUAL WASTEWATER SYSTEM IN COASTAL AREAS AND THE WAIMANALO WWTP 9-2

USE OF RECLAIMED WATER FOR IRRIGATION 9-2

BENEFICIAL REUSE OF WASTEWATER SLUDGE 9-3

CHAPTER 10 - ORGANIZATIONS AND PERSONS CONSULTED

LIST OF ORGANIZATIONS/PERSONS CONSULTED AND COPIES OF SEISPN COMMENT/RESPONSE LETTERS 10-1

LIST OF ORGANIZATIONS/PERSONS CONSULTED AND COPIES OF DSEIS COMMENT/RESPONSE LETTERS 10-39

PUBLIC INPUT DURING PREPARATION OF THE WAIMANALO WASTEWATER FACILITIES PLAN 10-92

 Resident Survey 10-92

 Public Information Meetings 10-107

LIST OF PREPARERS 10-130

TABLE OF CONTENTS (Continued)

Page No.

CHAPTER 11 - REFERENCES

APPENDICES

APPENDIX A	WAIMANALO WWTP UPGRADE TECHNICAL INFORMATION
APPENDIX B	WATER QUALITY STANDARDS AND PARAMETERS
APPENDIX C	LITERATURE REVIEW ON INDIVIDUAL WASTEWATER SYSTEMS
APPENDIX D	GROUNDWATER INVESTIGATION REPORT

LIST OF FIGURES

Figure 1-1	Planning Area	1-2
Figure 1-2a	Projected Future Developments and Proposed Collection System Improvements (West Side)	1-5
Figure 1-2b	Projected Future Developments and Proposed Collection System Improvements (East Side)	1-6
Figure 1-3	Site Plan for Proposed New Waimanalo WWTP Facilities	1-9
Figure 1-4	Proposed Reclaimed Water Irrigation Sites and Infrastructure	1-11
Figure 3-1	Average Annual Rainfall	3-3
Figure 3-2	Wind Rose	3-4
Figure 3-3	Topographic Map	3-5
Figure 3-4	Geologic Map	3-8
Figure 3-5	Generalized Geologic Cross Section AA	3-9
Figure 3-6	Soils Map	3-13
Figure 3-7	Conceptual Diagram of Groundwater Aquifers in Waimanalo	3-19
Figure 3-8	Streams, Irrigation Ditch System and Potable Water Wells/Tunnels	3-22
Figure 3-9	Stream Sampling Station Locations	3-24
Figure 3-10	Shoreline Sampling Stations	3-34

LIST OF FIGURES (Continued)		Page No.
Figure 3-11	Existing Sewered and Unsewered Developments	3-50
Figure 3-12	Proposed Future and Existing Developments To Be Sewered	3-55
Figure 3-13	Typical Cesspool System	3-70
Figure 3-14	Typical Septic Tank System	3-71
Figure 3-15	Individual Wastewater Systems Problem Cesspool Areas	3-77
Figure 3-16	Existing Storm Drainage Facilities and Drainage Waterways	3-79
Figure 3-17	Flood/Tsunami Inundation Areas	3-81
Figure 3-18	Archaeological and Historical Sites	3-87
Figure 4-1	State Land Use Districts	4-3
Figure 4-2	Agricultural Lands of Importance	4-5
Figure 4-3	Koolaupoko Development Plan	4-9
Figure 4-4	Zoning and Special Management Area (SMA) Map	4-12
Figure 5-1	Photograph of Algal Bloom in Waimanalo Bay	5-19
Figure A-1	Proposed Future Waimanalo WWTP Process Flow Schematic	A-8
Figure B-1	Classification of Waimanalo Marine Waters	B-2

LIST OF TABLES

Table 1-1	Budgetary Construction Cost Estimate Summary for Proposed Action	1-12
Table 1-2	Recommended Implementation Priority List	1-16
Table 1-3	Comparison of 1984 and Current Waimanalo Wastewater Facilities Plan	1-17
Table 2-1	Comparison Summary of Capacity Remediation Alternatives	2-4
Table 2-2	Comparison Summary of Individual Wastewater System and Centralized Wastewater Collection and Treatment Alternatives	2-9
Table 2-3	Comparison Summary of Biological Treatment Alternatives	2-23
Table 2-4	Comparison Summary of Effluent Disposal Alternatives	2-37

LIST OF TABLES (Continued)

Page No.

Table 3-1	Characteristics of Soil Types Found in the Waimanalo Planning Area	3-15
Table 3-2	Aquifer Classifications in Waimanalo Planning Area	3-18
Table 3-3	Waimanalo Stream Mean Physical/Chemical Data Summary	3-25
Table 3-4	Waimanalo Stream Expanded Physical/Chemical Data Summary	3-26
Table 3-5	Waimanalo Stream Mean Bacteriological Data Summary	3-29
Table 3-6	Waimanalo Bay Station No. 4 Water Quality Data	3-35
Table 3-7	Waimanalo Bay Shoreline Bacteriological and Salinity Water Quality Data	3-38
Table 3-8	Estimated Existing Population and Household Size	3-51
Table 3-9	Traffic Analysis Zone (TAZ) Projections	3-53
Table 3-10	Future Department of Hawaiian Home Lands Developments	3-56
Table 3-11	Projected Year 2020 Populations for Sewer Service Areas	3-63
Table 3-12	Estimated Individual Wastewater Systems in Waimanalo	3-73
Table 3-13	Summary of City Cesspool Pumpings in Waimanalo During 1995	3-75
Table 3-14	Existing Recreational and Open Space Resources in the Waimanalo Planning Area	3-83
Table 3-15	Historic Places in the Waimanalo Planning Area	3-86
Table 4-1	State Land Use Districts in the Waimanalo Planning Area	4-2
Table 4-2	Planning Area Zoning	4-13
Table 10-1	Individual Wastewater System Survey Basic Information Summary	10-93
Table 10-2	Survey Results on Sewer Construction Issue	10-95
Table A-1	Conceptual Year 2020 Design Data and Recommendations for Upgrade of the Waimanalo WWTP	A-1
Table B-1	Summary Classification of State Water Based on Ecological Systems	B-4
Table B-2	Beneficial Uses of State Inland and Marine Waters by	

LIST OF TABLES (Continued)

Page No.

	Water Classification	B-5
Table B-3	State Receiving Water Quality Standards for Streams	B-7
Table B-4	State Receiving Water Quality Standards for Open Coastal Waters ..	B-8
Table C-1	Concentration of Pollutants in Household Wastewater	C-8
Table C-2	Nitrogen Removal Systems Construction Cost and Performance ..	C-14

Summary

SUMMARY

DESCRIPTION OF PROPOSED ACTION

The Waimanalo Wastewater Facilities Plan describes the basis and recommendations for collection system and treatment facility improvements to meet the wastewater management needs of the Waimanalo community to the year 2020. Capital improvement projects totaling approximately \$23 million are proposed.

Rehabilitation work on the western portion of the existing sewer system at an estimated cost of \$0.7 million is proposed to reduce infiltration and inflow of rainwater into the sewer lines during wet weather. The sewerage of approximately 350 existing homes in the coastal "beach lot area" of Waimanalo (Waimanalo Sewers, Section 2 Improvement District) is proposed to eliminate the use of individual wastewater systems in the area. This sewer project, which is estimated to cost \$5.8 million, currently has a low priority due to its high capital cost and uncertain water quality benefits.

Upgrade of motor controls and other miscellaneous improvements at the Kahawai Stream Wastewater Pump Station are proposed at an estimated capital cost of \$0.3 million.

Extensive improvements are proposed for the Waimanalo Wastewater Treatment Plant (WWTP) to increase its average design capacity from 0.7 mgd to 1.1 mgd at an estimated cost of \$16.1 million. Major proposed improvements include a new anoxic-aerobic activated sludge biological secondary treatment process, an effluent filtration system, additional injection wells, new sludge thickening facilities, an upgraded electrical system, and expanded personnel and maintenance facilities. Other proposed improvements to allow production of reclaimed water for irrigation include an ultraviolet disinfection system and effluent pumping facilities. Reclaimed water is targeted for use at selected agricultural farm lot sites and the Olomana Golf Links.

SIGNIFICANT BENEFICIAL AND ADVERSE IMPACTS

Water Quality and Public Health Protection

The proposed wastewater facility improvements will have beneficial long term impacts on water quality within the Waimanalo area. The proposed rehabilitation of the sewers will reduce wet-weather infiltration and inflow of extraneous rainwater into the wastewater system. This will reduce the probability of spillage of untreated sewage from the wastewater collection system and the Waimanalo WWTP during extreme

storm events and thereby improve water quality and public health protection. The reduction in peak wet weather flows will also improve the performance of the Waimanalo WWTP during the high flow periods.

If implemented, the proposed installation of sewers to eliminate the use of approximately 350 individual wastewater systems in the coastal beach lot area will reduce the contribution of nitrogen, an undesirable biostimulatory nutrient, into Waimanalo Bay. This would eliminate one of the suspected contributing causes of periodic algal blooms in the Waimanalo coastal waters. Spills and wastewater system backups caused by defective or overloaded individual wastewater systems will be eliminated to provide some additional long-term benefits to public health and water quality. *The capital cost of the sewers, excluding the cost of lateral sewers within private property, is estimated to be approximately \$16,000 per home.*

The proposed wastewater system improvements do not propose to sewer all areas currently served by onsite individual wastewater systems due to economic constraints and limited anticipated benefits. Public health concerns due to spills from existing overloaded systems in areas not proposed to be sewered will need to be mitigated by expanding existing or constructing new individual wastewater disposal systems. The homeowners will be responsible for upgrading failing individual wastewater systems on their properties.

Expansion of the wastewater collection system will increase wastewater flows at the Waimanalo WWTP and the discharge of effluent into the groundwater via subsurface injection disposal wells. Implementation of the proposed improvements to the treatment facilities, however, will significantly improve the level and reliability of treatment, and reduce the level of nitrogen in the effluent. The proposed effluent reuse will reduce the demand for *potable* water and potentially allow for additional crop production in Waimanalo.

Economic, Land Use, Social and Other Long Term Impacts

The estimated \$23 million capital cost of the proposed facility upgrades is expected to be largely funded with State and City funds. Residents currently with individual wastewater systems that will be served by the expanded sewer system will be responsible for sewer connection costs, assessment fees and monthly service charges.

The proposed improvements to the wastewater facilities will allow additional development to occur in Waimanalo. Increased development in Waimanalo may potentially have secondary long term impacts such as increased traffic congestion; added needs for schools, parks and other public facilities; additional demands on utility systems; and further loss of the rural agricultural nature of Waimanalo. The

anticipated growth, however, is generally consistent with City and County of Honolulu Planning Department projections and land use policies for the area.

Much of the projected growth in Waimanalo is associated with DHHL and OHA projects that benefit persons of Hawaiian descent. These projects will benefit those who are economically disadvantaged, families currently housed in overcrowded dwellings, and elderly persons.

The proposed expansion and upgrade of the Waimanalo WWTP will increase energy consumption due to the added treatment processes and increased capacity of the facilities.

The future use of ultraviolet disinfection in lieu of chlorine gas for disinfection of reclaimed water at the Waimanalo WWTP will benefit the community by eliminating safety hazards associated with the transportation and handling of chlorine gas.

Short Term Impacts

Short-term impacts are limited primarily to temporary disruptions associated with construction activities. Temporary adverse impacts include those associated with aesthetics, noise, dust, construction equipment exhaust, construction dewatering/runoff discharges, and traffic congestion. The project will provide employment for those in the construction industry.

PROPOSED MITIGATION MEASURES

Potential concerns with the increased nitrogen loading on groundwater and nearshore coastal waters due to increased subsurface injection of treated effluent will be mitigated by the use of a nitrogen removal process at the Waimanalo WWTP. Financial impacts will be partly mitigated by distribution of the City's portion of the costs among the large number of wastewater system customers on Oahu. Low interest loans and recovery of costs from users of the reclaimed water will also help mitigate financial impacts. Some of the adverse impacts associated with the growth of Waimanalo's population can be mitigated by timely planning and implementation of other supporting infrastructure improvements. Appropriate planning and design of new developments to help maintain the rural agricultural characteristics of Waimanalo should be utilized to the extent possible. Energy consumption impacts will be mitigated by the use of energy efficient motors and process design.

Best Management Practices will be employed to reduce adverse noise, dust, construction dewatering/runoff discharges, and traffic impacts.

ALTERNATIVES CONSIDERED

Major alternatives to the proposed actions that were considered included the following:

- Construct relief sewer and increase treatment plant capacity to accommodate peak wet weather flows in lieu of sewer rehabilitation.
- Continue utilizing individual wastewater systems.
- Utilize pressure sewer systems in lieu of gravity sewer systems.
- Utilize other low and high technology treatment systems.
- Continue utilizing *gas or liquid chlorine* for effluent disinfection.
- Utilize rapid infiltration trenches, ocean outfall, or transmission to the Kailua Regional Wastewater treatment plant for effluent disposal.

UNRESOLVED ISSUES

The following is a summary of unresolved issues:

- The source of funds for the proposed capital improvements is a major unresolved issue. Currently, the Waimanalo WWTP is owned by the State of Hawaii, and operated and maintained by the City. The City Department of Environmental Services and the State Department of Land and Natural Resources are currently negotiating to resolve wastewater facility financing and management issues. Financing and cost sharing issues for additional facilities to produce and convey reclaimed water are also unresolved among the potential water users and various government agencies.
- The construction schedule for the majority of the proposed facilities is unresolved as it will be largely dependent on the availability of funding for the improvements.
- The recommended sizing of treatment facilities is potentially subject to reevaluation during the engineering design phase due to revisions to the Koolaupoko Development Plan. *The public review draft of the revised Koolaupoko Development Plan is expected to be completed by December 1998 and the final revised is not expected to be effective until mid-1999 or later.*

- The 100-year flood elevations at the Waimanalo WWTP may potentially be increased in the future based on a March 1997 Inoaole Stream flood study by the U.S. Army Corps of Engineers (R.M. Towill, 1997). The extent and timetable for the flood elevation revisions are uncertain.
- The extent of public health and water quality benefits of installing sewers to eliminate the use of individual wastewater systems in the low-lying coastal areas is uncertain. The discharge of nitrogen is the primary concern. There is also some concern *about* treated effluent from the Waimanalo WWTP injection wells surfacing in the nearshore coastal waters. Additional investigations to address these concerns and to quantify and assess other sources of nitrogen in the Waimanalo watershed are recommended.
- The extent to which reclaimed water will be used for irrigation is uncertain. The Olomana Golf Links will likely require funding from other sources for reclaimed water use to be cost-effective. The extent of irrigation of the agricultural farm lots with reclaimed water may be slightly reduced by Honolulu Board of Water Supply restrictions to protect its drinking water sources. The extent of farm lot irrigation will also be dependent on the pricing structure of the reclaimed water and the cost-effectiveness of bringing additional land into production in areas experiencing water shortages.
- The future of the City's managed beneficial reuse program for its wastewater sludge is uncertain at the present time.

COMPATIBILITY WITH LAND USE PLANS AND POLICIES

The recommendations of the Waimanalo Wastewater Facilities Plan are generally consistent with applicable land use policies and plans. The proposed actions are expected to help achieve the environmental quality objectives expressed in the State Plan, the City and County of Honolulu General Plan, the Koolaupoko Development Plan, and other applicable land use policies. The proposed facilities will support existing development as well as future development envisioned by the land use plans and policies.

The facilities plan proposes a less extensive sewerage plan to eliminate existing cesspools than the 208 Water Quality Management Plan for the City and County of Honolulu (C&C of Honolulu and DOH, 1990) due to high capital costs. In the "Bell Street area" of Waimanalo, it was concluded that performing required upgrades to the existing individual wastewater systems would be a more cost-effective alternative.

LISTING OF PERMITS OR APPROVALS

Permits and approvals which are anticipated to be required for construction and operation of the proposed facilities are as follows:

State Permits/Approvals

Construction plan approvals	Department of Health, Department of Transportation
Engineering reports and submittals for reclamation facilities	Department of Health
Engineering reports and submittals for water reclamation reuse projects	Department of Health
Underground Injection Control (UIC) permit	Department of Health
<i>NPDES permit (construction dewatering and storm water runoff from a construction site)</i>	Department of Health
Community noise permit	Department of Health
Permit to perform work upon a State highway	Department of Transportation

City and County of Honolulu Permits/Approvals

Construction plan approvals	Department of Design & Construction
Building permit for building, electrical, plumbing, sidewalk/driveway, and demolition work	Department of Planning & Permitting
Grubbing, grading and stockpiling permit	Department of Planning & Permitting
Permit to excavate public right-of-way (trenching)	Department of Planning & Permitting
Street usage permit	Department of Planning & Permitting
Construction dewatering permit (temporary)	Department of Planning & Permitting
Permit to discharge effluent (temporary)	<i>Department of Environmental Services</i>

City and County of Honolulu Permits/Approvals (continued)

Special Management Area Use Permit	Department of Planning & Permitting
Flood hazard variance	Department of Planning & Permitting
Flammable and combustible liquids-tank installation	Honolulu Fire Department

Chapter 1

Proposed Action

CHAPTER 1

PROPOSED ACTION

PURPOSE AND NEED FOR PROPOSED ACTION

The City and County of Honolulu Department of Design and Construction (DDC) is in the process of updating *the Waimanalo Wastewater Facilities Plan originally prepared by the City in 1984*. This planning document describes the basis and recommendations for collection system and treatment facility improvements to meet the wastewater management needs of the Waimanalo community to the year 2020. Most of the facilities were built in 1984.

Background and Historic Perspective

The Waimanalo planning area is located on the southeast end of Oahu (see Figure 1-1). The area currently has an estimated resident population of 9,400. The Waimanalo community is comprised of single family dwellings, townhouses, agricultural lots, schools and other community facilities, and small scale commercial developments. Approximately six percent of the planning area is zoned for residential use and 41 percent is zoned for agricultural use. The Waimanalo planning area also encompasses the Bellows Air Force Station to the west and the Sea Life Park/Makai Pier complex to the east.

Approximately 65 percent of the Waimanalo residents are serviced by a wastewater collection system and centralized treatment and disposal facilities (see Figure 1-1). Wastewater is collected by a network of gravity sewers for treatment at the Waimanalo Wastewater Treatment Plant (WWTP). The Kahawai Wastewater Pump Station (WWPS) and force main pumps wastewater generated by the western end of the system into the main gravity trunk sewer.

Much of the Waimanalo wastewater facilities, including the Waimanalo WWTP, the Kahawai WWPS, and a substantial portion of the sewer system, *were* constructed with State funds through the Department of Land and Natural Resources (DLNR). The Department of Hawaiian Home *Lands* (DHHL) has been responsible for the construction of sewers within most of the DHHL subdivisions. Under an agreement with the State, the City and County of Honolulu Department of Environmental Services (ENV)¹ operates and maintains the sewers, pump station and treatment facilities

¹The Department of Environmental Services was previously known as the Department of Wastewater Management (WWM) prior to the City and County of Honolulu's recent reorganization.

DATE: 01/05/98
 SCALE: 1" = 4000'
 FILE: 9524-88

MS
 PM: *SIA/FA
 OPER: *SIA/FA
 REVISED: 07/23/98

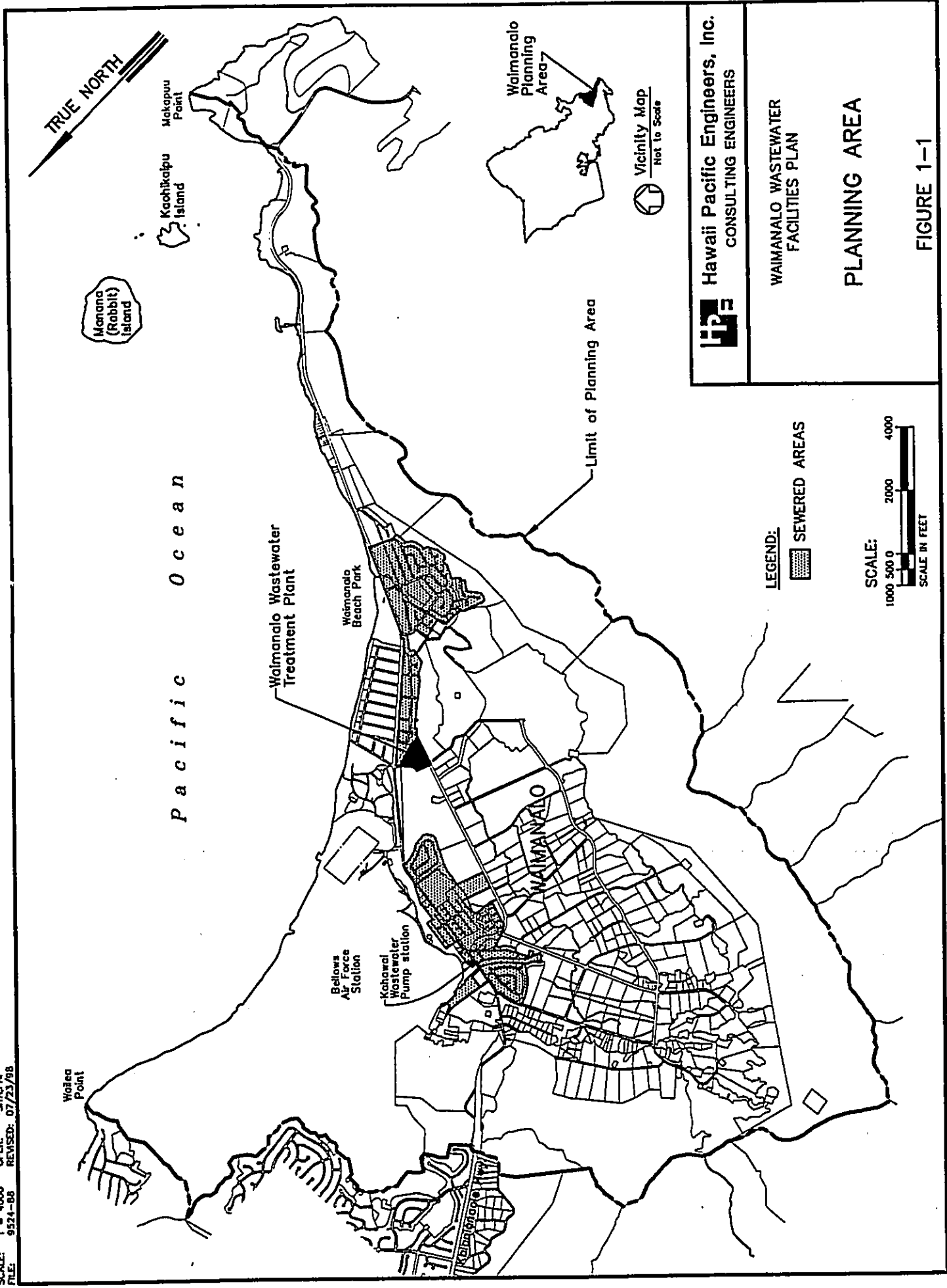

LEGEND:
 SEWERED AREAS

SCALE:
 1000 500 0 2000 4000
 SCALE IN FEET

LPE Hawaii Pacific Engineers, Inc.
 CONSULTING ENGINEERS

WAIMANALO WASTEWATER FACILITIES PLAN
 PLANNING AREA
 FIGURE 1-1

constructed by DLNR. The City also provides some assistance to DHHL with maintenance of sewers owned by DHHL. Actual ownership of sewers by the City in Waimanalo is generally limited to sewer lines that were constructed by the City and are located within streets under City jurisdiction.

The homes in Waimanalo that are not connected to sewers are served by individual wastewater systems, generally consisting of cesspools or septic tank/leach field systems. These unsewered areas include certain portions of the lower coastal areas and all of the inland agricultural lots. In addition, approximately 13 percent of the homes in sewer areas have not connected to the sewer system and continue to use individual wastewater systems.

The Waimanalo WWTP, which was originally constructed in 1969, has a rated average design capacity of 0.7 million gallons per day (mgd). The plant has a current average flow of approximately 0.6 mgd.

Need for Upgrade and Expansion of Wastewater Facilities

Maintaining high water quality in Hawaii's coastal waters has many important benefits. Water quality is important to ecosystem and species health and diversity; leisure and recreation (swimming, boating, snorkeling, SCUBA diving, and surfing); fishing and other food gathering activities; tourism and economic strength; research and technology; and Native Hawaiian cultural practices. There are also many undesirable consequences of water pollution. They include increased risk of illness from water recreation, algal blooms, fish kills, adverse impacts to coral growth and aquatic habitats, and turbid waters.

Waimanalo is well known for its white sand beaches and marine recreational activities. Currently, there are water quality concerns associated with the continued use of individual wastewater systems (primarily cesspools) in the lower coastal areas. Algal blooms have been reported to occur periodically in the nearshore waters of Waimanalo Bay. It is uncertain whether nutrients, particularly nitrogen, from individual wastewater systems are promoting the algal blooms. Nutrients from non-point stormwater runoff may also be a significant factor. Sewering the coastal areas to decrease the number of individual wastewater systems would contribute toward reducing the nutrient loading on the nearshore waters.

On the western side of the collection system, calculations indicate the capacity of the trunk sewer may be exceeded under current conditions by peak wet weather flows occurring during heavy rainfall (six-hour design storm having a five-year recurrence interval). The inadequate capacity may be attributed to excessive infiltration and inflow of stormwater into the sewers in certain portions of the service area. Repair

and rehabilitation of the defective sewers are required to reduce the probability of wet-weather spills from the collection system and minimize excessive hydraulic loading on the treatment facility.

The Waimanalo WWTP is currently experiencing unstable performance which results in periodic effluent quality violations. Treated secondary effluent is currently disposed by means of subsurface injection wells. The existing capacity of the *injection* wells is marginally adequate due to clogging of the wells from excessive suspended solids in the effluent. These problems at the Waimanalo WWTP can be attributed to *the* increase in the service area population and loadings, and the use of an outdated liquid stream treatment process. The Waimanalo WWTP is currently unable to effectively handle the high level of wet weather collection system infiltration and inflow without significant degradation of effluent quality. There is currently a moratorium on new sewer connections due to the capacity limitations of the Waimanalo WWTP. This *has* resulted in delays and difficulties in implementing new residential and commercial development projects.

STATEMENT OF OBJECTIVES

The objectives of the wastewater facility upgrades and improvements recommended in the Waimanalo Wastewater Facilities Plan include:

- Enhance coastal water quality and promote protection of public health,
- Improve the reliability, performance and capacity of wastewater facilities,
- Provide sewer service to future developments, and
- Comply with applicable public health and pollution control regulatory requirements.

The intent of the facilities plan is to identify and recommend improvements to the wastewater collection, treatment and disposal system that can most cost-effectively meet the above objectives.

DESCRIPTION OF PROPOSED ACTION

The following discussions summarize the proposed upgrade and expansion of wastewater facilities recommended by the Waimanalo Wastewater Facilities Plan. The improvements will support the projected future development in Waimanalo as shown on Figure 1-2a and 1-2b.

DATE: 03/25/88
 SCALE: 1" = 1200'
 FILE: 9324-34A

MS
 SIA/FALCOX
 OPER:
 REVISED: 7/23/88

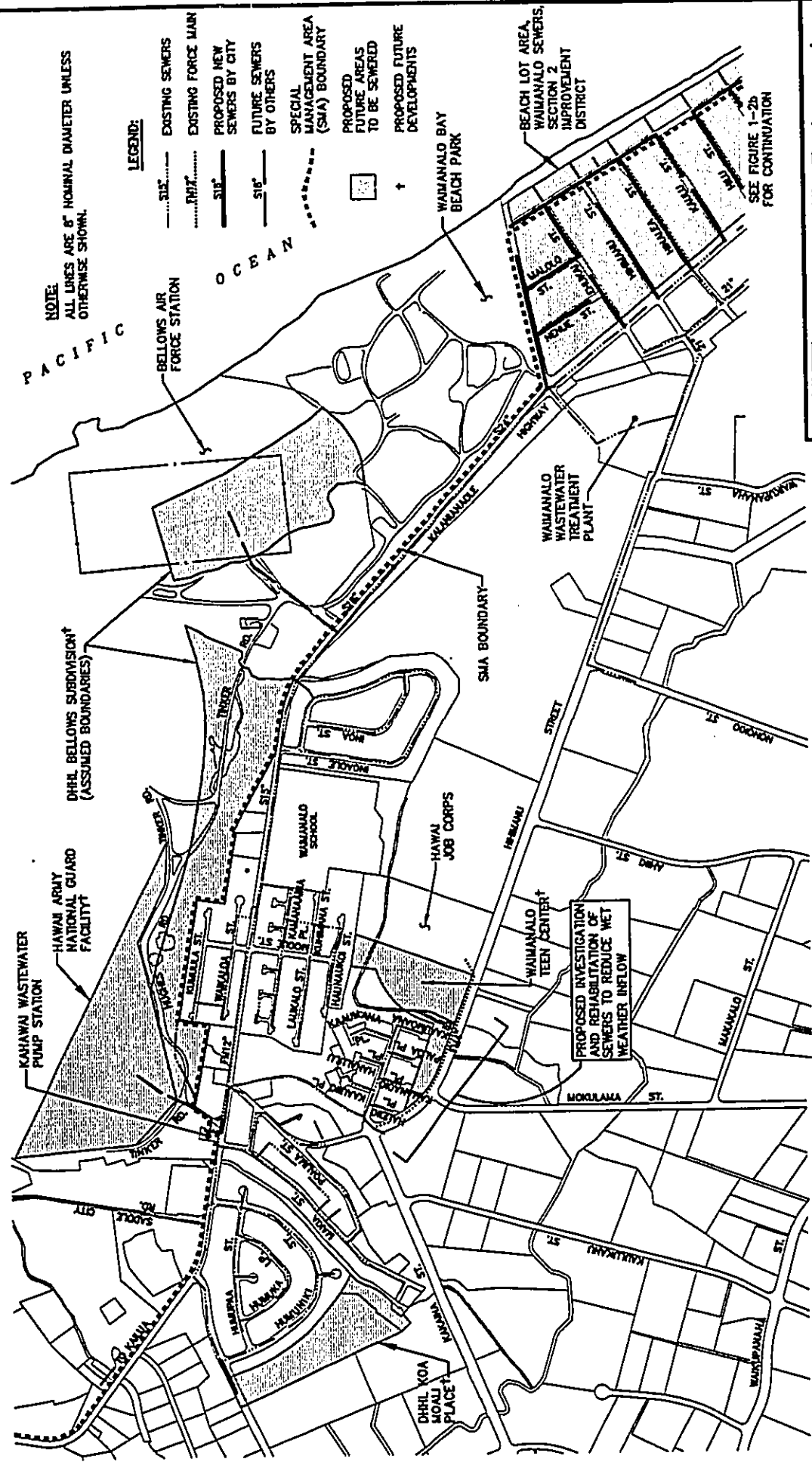

HPe Hawaii Pacific Engineers, Inc.
 CONSULTING ENGINEERS

WAIMANALO WASTEWATER FACILITIES PLAN

PROJECTED FUTURE DEVELOPMENTS AND PROPOSED COLLECTION SYSTEM IMPROVEMENTS (WEST SIDE)

FIGURE 1-2a

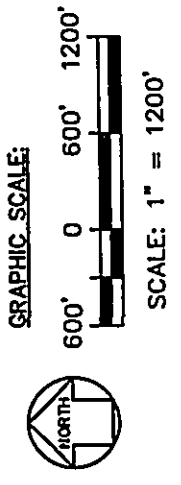

**PROJECTED FUTURE DEVELOPMENTS
AND PROPOSED COLLECTION SYSTEM
IMPROVEMENTS (EAST SIDE)**

FIGURE 1-2b

DATE: 03/25/88
SCALE: 1" = 1200'
FILE: 8324-83A

MS
SIA/FALCON
REMSID: 7/23/88

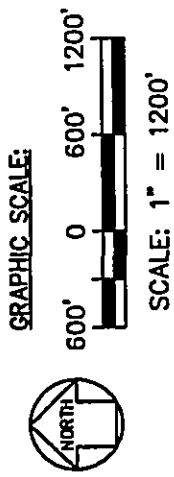

BEACH LOT AREA,
WAIMANALO SEWERS, SECTION 2 IMPROVEMENT DISTRICT
(Implementation of sewerage to be
based on additional water quality
investigations.)

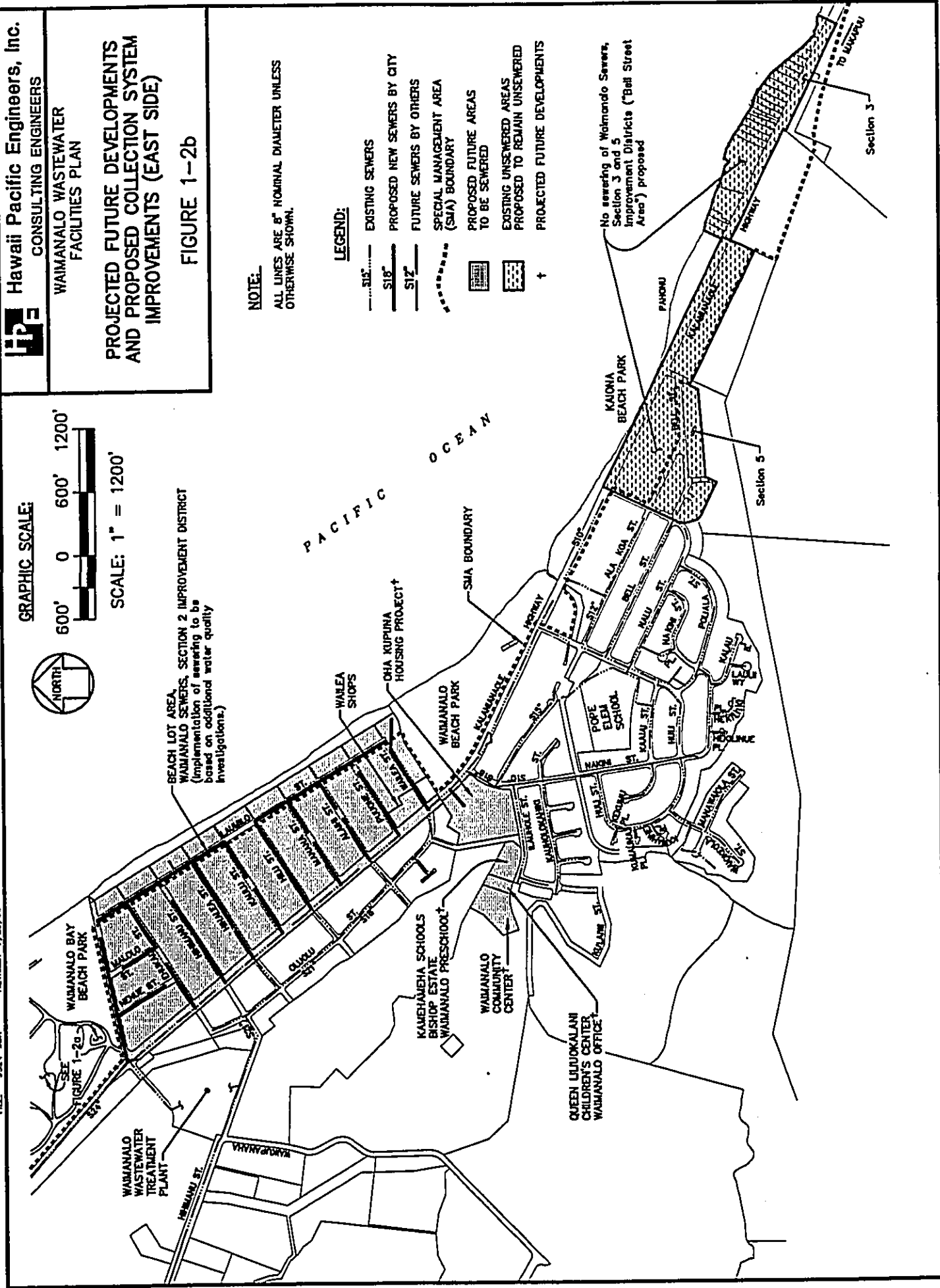

NOTE:

ALL LINES ARE 6" NOMINAL DIAMETER UNLESS OTHERWISE SHOWN.

LEGEND:

- EXISTING SEWERS
- - - PROPOSED NEW SEWERS BY CITY
- · · FUTURE SEWERS BY OTHERS
- - - SPECIAL MANAGEMENT AREA (SMA) BOUNDARY
- [Cross-hatched] PROPOSED FUTURE AREAS TO BE SEWERED
- [Dotted] EXISTING UNSERWERED AREAS PROPOSED TO REMAIN UNSERWERED
- † PROJECTED FUTURE DEVELOPMENTS

No sewerage of Waimanalo Sewers, Section 3 and 5 Improvement Districts ("Bat Street Area") proposed

Sewer Rehabilitation

Rehabilitation work on the western portion of the existing sewer system is proposed to reduce infiltration and inflow of stormwater into the sewer lines during wet weather (see Figure 1-2a). This work would include conducting investigations to locate sewer defects, and reconstructing or lining the sewers and manholes. This action will reduce the magnitude of the wet weather peak flow in the collection system and at the Waimanalo WWTP. This in turn will lower the probability of wastewater spills and minimize capital expenditures required to increase the capacity of the system. The performance of the Waimanalo WWTP during wet weather periods would also be improved. Additional sewer rehabilitation work may also be performed in other areas to reduce dry weather groundwater infiltration.

Sewering of Existing Development

The sewerage of approximately 350 existing homes in the coastal "beach lot area" of Waimanalo (Waimanalo Sewers, Section 2 Improvement District) is proposed to eliminate the use of individual wastewater systems in the area (see Figure 1-2b). The project would involve construction of approximately 14,500 linear feet of 8-inch and 6-inch gravity sewers *mostly* within the street right-of-way. The depths of the sewers would typically range from 4 to 15 feet below the existing grade. Some of the deeper sewers would be located below the water table. This sewer project currently has a low priority due to its high capital cost and uncertain benefits (see discussion on alternatives in Chapter 2). In addition, the majority of homeowners in the areas to be sewerage were opposed to the project.² Additional studies are recommended to evaluate the anticipated water quality benefits of the project prior to its implementation.

Kahawai Stream Wastewater Pump Station Upgrade

The Kahawai Stream Wastewater Pump Station (WWPS), rated for a peak flow of 2.6 million gallons per day (mgd), is projected to have adequate future capacity provided that the sewer rehabilitation work discussed above is implemented. Upgrade of the motor controls with a state-of-the-art energy efficient variable frequency drive system is recommended. The installation of a new fire hydrant to provide the facility with adequate fire protection is also recommended. Upgrade of the pumps to increase capacity may be implemented in the event that sewer rehabilitation work does not reduce the future peak flow to below 2.6 mgd.

²A mail-out survey was conducted. See discussions in Chapter 10.

Waimanalo Wastewater Treatment Plant Upgrade

Extensive improvements are proposed for the Waimanalo WWTP to increase its average design capacity from 0.7 mgd to 1.1 mgd to accommodate the projected year 2020 wastewater flows (see Figure 1-3). The improvements will mitigate existing treatment reliability problems and concerns associated with the existing facilities.

The proposed improvements include the following:

- A new secondary biological treatment process utilizing an anoxic-aerobic activated sludge process to provide improved treatment performance and reliability, increased flow handling capacity, and biological nutrient removal capability.
- Granular media effluent filtration facilities to improve suspended solids removal, reduce clogging of the effluent disposal wells, and facilitate future effluent reuse.
- Three additional injection wells to increase effluent disposal capacity.³
- Sludge thickening facilities utilizing a dissolved air flotation (DAF) thickener system to facilitate sludge handling.
- Retrofit of existing sludge drying beds with plastic media and a polymer feed system to decrease drying time, increase drying capacity, *reduce labor costs, and minimize sludge handling.*
- Equalization basin to minimize undesirable diurnal flow variations on downstream processes.
- An ultraviolet disinfection system, chemical feed system, and effluent pumping facilities to allow production of reclaimed water for irrigation reuse. The use of gas chlorination is being discontinued due to safety concerns.
- Other miscellaneous improvements, including upgrade of the electrical system and standby power facilities, expanded personnel and maintenance facilities, and flood proofing of existing buildings and critical plant components.

³Depending on the results of capacity tests to be conducted on six existing wells that will remain in use and the capacity of the new wells, more than three wells may potentially be required to meet the State Department of Health's reserve well capacity requirements. It should be noted that a seventh existing well is partially collapsed but is still on-line and included in the facility's Underground Injection Control (UIC) permit. This well will be removed from service in the future.

DATE: 01/05/98
 SCALE: 1" = 100'
 FILE: 9524-92A

MS
 PH: SH
 OPER: SH
 REVISED: 7/23/98

GRAPHIC SCALE:

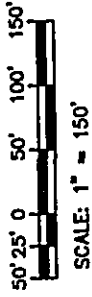

HP Hawaii Pacific Engineers, Inc.
 CONSULTING ENGINEERS

WAIMANALO WASTEWATER
 FACILITIES PLAN

**SITE PLAN FOR PROPOSED
 NEW WAIMANALO WWTP
 FACILITIES**

FIGURE 1-3

- LEGEND**
- PROPOSED NEW FACILITIES
 - FUTURE FACILITIES
 - PROPOSED NEW PAVEMENT
 - EXISTING FACILITIES
 - EXISTING FACILITIES TO BE MODIFIED

* Locations of injection wells to be determined based on detailed geotechnical investigations.

Note:
 Proposed improvements shown are conceptual in nature. The proposed facility improvements and layouts are subject to revision during the design phase of the projects.

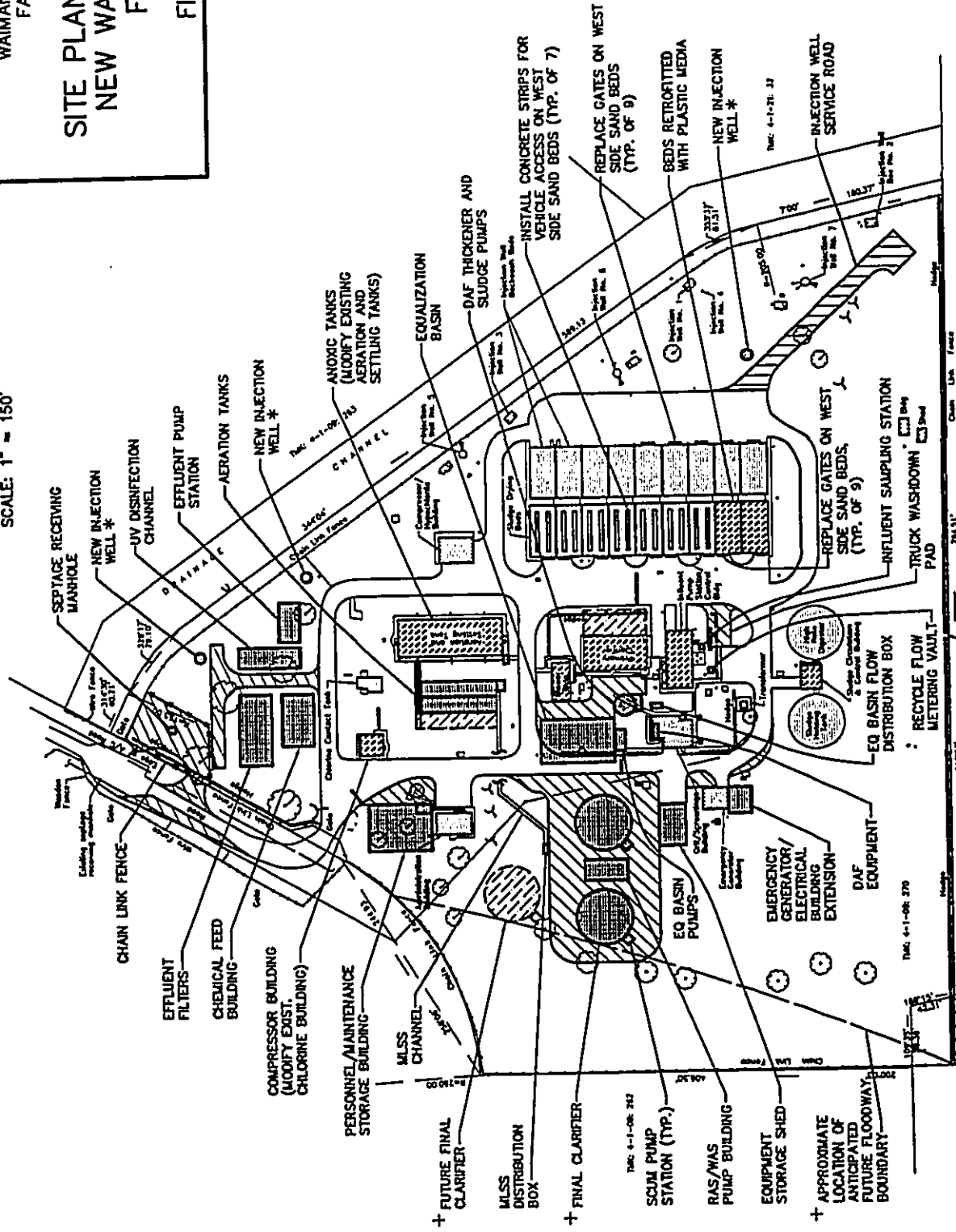

+ Clarifiers to be located outside of future floodway boundary. See discussions in Chapter 5.

The proposed facility improvements described above are subject to revisions and refinement during the design stage of the projects. Any revisions that result in significant changes to the impact on the environment (i.e., odors, noise, visual impacts, etc.) will be subject to a supplemental environmental impact statement or environmental assessment.

The facility improvements will be designed to comply with the requirements of Chapter 62, "Wastewater Systems," and Chapter 23, "Underground Injection Control," of the Hawaii Administrative Rules, Title 11, and other applicable regulations and guidelines.

Reclaimed water is targeted for use at selected agricultural farm lot sites and the Olomana Golf Links (see Figure 1-4). The irrigation of agricultural farm lots will involve the construction of a transmission line to a new 3.5 million gallon two-cell effluent reservoir constructed adjacent to the existing Wing King Reservoir. If effluent is utilized at the Olomana Golf Links, a second effluent transmission main along Kalaniana'ole Highway will be constructed. The two proposed effluent irrigation scenarios are described in greater detail in the discussion of alternatives in the next chapter.

Composting of sludge for beneficial reuse is not proposed at the Waimanalo WWTP site due to concerns with site flooding problems and generation of odors. Sludge processing for beneficial reuse, if implemented in the future, is anticipated to occur at an offsite centralized or regional facility that is not located in Waimanalo.

Additional technical information on the proposed Waimanalo WWTP upgrade work is presented in Appendix A. The additional information includes process flow diagrams and conceptual design data.

USE OF PUBLIC FUNDS AND LANDS

Funding

The total estimated capital cost for the proposed wastewater facility improvements is \$22.8 million. A summary of the costs is presented in Table 1-1.

The capital cost of the improvements at the Waimanalo WWTP is estimated to be \$16.1 million. The DLNR is expected to fund a substantial portion of the wastewater facility capital improvement costs due to ownership of the facilities by the State. Low interest loans from the State Revolving Fund (SRF) program administered by the State Department of Health may potentially be used. DHHL and other government agencies or private developers performing future development work in Waimanalo would be expected to fund a portion of the capital costs through facility charges.

DATE: 01/05/88 PM: MS
 SCALE: 1"=2000' OPER: SHI, CLK
 FILE: 9524-89 REVISED: 7/23/88

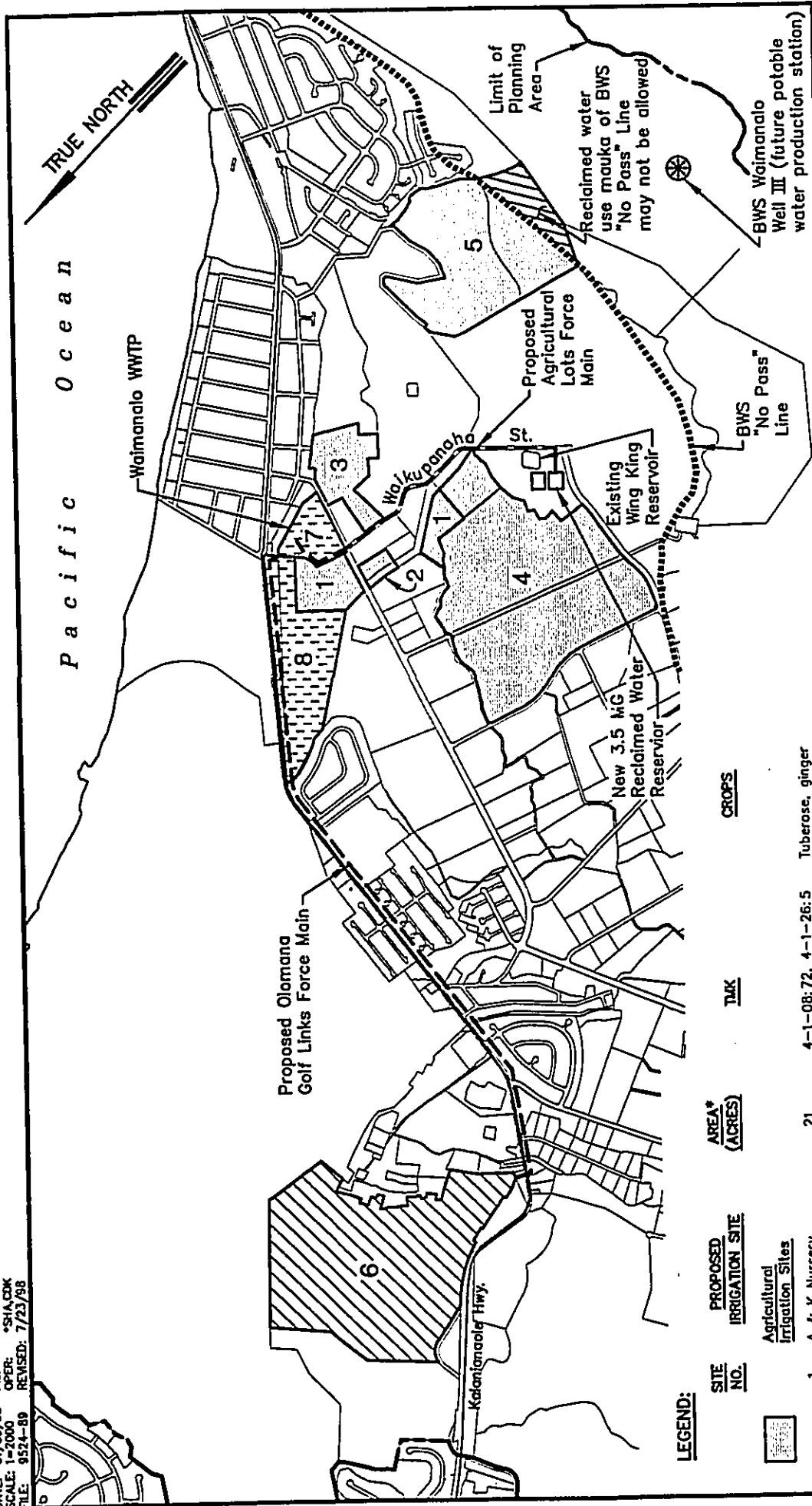

HPE Hawaii Pacific Engineers, Inc.
 CONSULTING ENGINEERS

WAIMANALO WASTEWATER
 FACILITIES PLAN

**PROPOSED RECLAIMED WATER
 IRRIGATION SITES AND
 INFRASTRUCTURE**

FIGURE 1-4

LEGEND:

SITE NO.	PROPOSED IRRIGATION SITE	AREA* (ACRES)	TAK	CROPS
Agricultural Irrigation Sites				
1.	A & K Nursery	21	4-1-08:72, 4-1-26:5	Tuberose, ginger
2.	Hasebe	2	4-1-26:62A	Ginger, papaya
3.	Omizo	14	4-1-26:72	Banana, Chinese peas, beans
4.	UH Agricultural Experimental Station	128	4-1-26:2, 4-1-26:13	Banana, various truck crops
5.	Wong	48	4-1-08:79	Corn
Other				
6.	Olomana Golf Links	130	4-1-13:10	
Other				
7.	Waimanalo WWTP	10	4-1-09:270	
8.	Waimanalo Polo Club	34	4-1-09:242	

* Approx. Area of parcel. Entire parcel will not be irrigated.

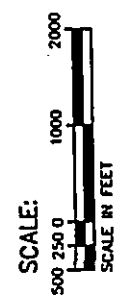

**TABLE 1-1
BUDGETARY CONSTRUCTION COST ESTIMATE SUMMARY
FOR PROPOSED ACTION**

<u>Item</u>	<u>Quantity</u>	<u>Unit</u>	<u>Unit Price</u>	<u>Subtotal</u>
<u>Sewer Rehabilitation</u>				
Rehabilitate/Reconstruct Sewers (Upstream of Kahawai WWPS)	1,500	LF	300	450,000
Miscellaneous Rehabilitation Work	1	LS	200,000	<u>200,000</u>
				Sewer Rehabilitation Subtotal
				\$650,000
<u>Kahawai Stream Wastewater Pump Station</u>				
Electrical Upgrade/VFD	1	LS	230,000	230,000
Miscellaneous Work	1	LS	20,000	<u>20,000</u>
				Kahawai Stream WWPS Subtotal
				\$250,000
<u>Waimanalo Sewer Improvement District No. 2 (Beach Lots; approx. 350 dwellings)</u>				
6" Sewers & Appurtenances	640	LF	350	224,000
8" Sewers & Appurtenances	13,720	LF	400	5,488,000
Miscellaneous Work	1	LS	50,000	<u>50,000</u>
				Sewer Improvement Subtotal
				\$5,762,000
<u>Waimanalo Wastewater Treatment Plant (Q_{AVG} = 1.1 mgd)</u>				
Mobilization & General Sitework	1	LS	130,000	130,000
Septage Receiving Manhole	1	LS	70,000	70,000
Influent Pump Station Pump/Misc.	1	LS	145,000	145,000
Influent Sampling Modifications	1	LS	110,000	110,000
Grit/Screen/Primary Clarifier Upgrade	1	LS	60,000	60,000
Equalization Basin	1	LS	1,090,000	1,090,000
Anoxic/Aeration Tanks/Blower Upgrade	1	LS	2,405,000	2,405,000
Final Clarifiers	2	EA	1,205,000	2,410,000
Sludge Pump Station	1	LS	606,000	606,000
Effluent Filters with Chemical Feed	1	LS	2,132,000	2,132,000
Ultraviolet Disinfection Facility	1	LS	705,000	705,000
Effluent Pump Station	1	LS	762,000	762,000
Injection Wells	3	EA	381,000	1,143,000
DAF Thickener/Sludge Pumping	1	LS	680,000	680,000
Digester Recirculation Pumps	2	EA	30,000	60,000
Sludge Bed Improvements	1	LS	261,000	261,000
Water (Fire) System Upgrade	1	LS	380,000	380,000
Non-potable Water System	1	LS	20,000	20,000
Flood Proof Buildings/Components	1	LS	200,000	200,000
Personnel/Maintenance Bldg.	2,700	SF	300	810,000
Storage Shed/Garage	800	SF	70	56,000
Vehicle Washdown Pad	30	SY	100	3,000
Landscaping/Restoration	1	LS	30,000	30,000
Electrical	1	LS	1,870,000	<u>1,870,000</u>
				Waimanalo WWTP Subtotal
				\$16,138,000
<u>Total Budgetary Construction Costs</u>				\$22,800,000

The above estimated Waimanalo WWTP costs exclude the costs associated with proposed offsite effluent reuse facilities. The offsite facilities are anticipated to be funded primarily by users of the reclaimed water. Offsite reclaimed water infrastructure costs for irrigation of selected farm lots are expected to be funded by the State of Hawaii Department of Agriculture and with federal grant assistance from the National Resource Conservation Service (NRCS) of the U.S. Department of Agriculture.⁴ Reclaimed water transmission facilities to Olomana Golf Course may be funded by the golf course, but will likely require government subsidies for effluent reuse to be cost-effective. Government funding could potentially be justified on the basis of pollution abatement and potable water conservation benefits.

The collection system rehabilitation, pump station modifications, and sewerage of the beach lot area, which is anticipated to be funded by the City, is estimated to cost \$6.7 million. The collection system costs exclude the cost of installing sewers within any future new developments and the cost of additional lines or pumping facilities required to connect the new developments to the existing wastewater collection system. These costs are generally borne by the government agency or private entity developing the new property.

The cost of the sewer line rehabilitation work and pump station modifications is estimated to be \$0.6 million and \$0.3 million, respectively. These costs are anticipated to be funded by the City's wastewater operating budget.

The capital cost of the Sewer Improvement District No. 2 beach lot area, excluding building sewer lateral costs, is estimated to be \$5.8 million, or approximately \$16,000 per dwelling. The homeowner would be assessed a fee of \$2,500 for lots 10,000 square feet or larger (fee of \$0.25 per square foot of lot area up to a maximum of 10,000 square feet for the R-10 zoned parcels). Homeowners would be required to fill their existing cesspools and construct their own lateral sewers within their property to connect their homes to the new public sewers. The homeowner's cost for the cesspool filling and sewer lateral is estimated to be on the order of \$2,000 to \$4,000.

The funding for the Waimanalo WWTP capital improvement costs is subject to negotiations between the State and the City due to varying interpretations of past cost-sharing agreements. Negotiations are currently underway between the City and State administrations. The ability to secure appropriated funds from the City and State's respective legislative bodies will be a significant factor. Consideration is

⁴The proposed facilities for irrigation of the farm lots were previously addressed in "Final Watershed Plan and Environmental Impact Statement, Waimanalo Watershed," December 1981, prepared by the U.S. Department of Agriculture Soil Conservation Service (currently known as the NRCS).

currently being given to transfer of ownership of the wastewater facilities to the City following upgrade of the facilities to City standards.

The City and County of Honolulu would be expected to fund all the operating costs in addition to its portion of the capital costs. Based on current City policy, the City's portion of the cost would be *distributed* among all its wastewater system customers on Oahu.

Land

The proposed actions in the wastewater facilities plan involve the use of both State of Hawaii and City and County of Honolulu lands. The Waimanalo WWTP (TMK: 4-1-09:270) and Kahawai Stream Wastewater Pump Station (TMK: 4-1-15:16) are located on land owned by the State. The Waimanalo WWTP land is under the jurisdiction of the City under an Executive Order. The collection system sewers and force main are typically located in road right-of-ways that are either under the jurisdiction of the State or City.

PHASING AND TIMING OF ACTION

The proposed construction schedule will be largely dependent on the availability of funding for the improvements. Currently, the Department of Land and Natural Resources has secured funding only for the design and construction of the treatment plant effluent filters. Construction of the filters is expected to be completed in 1999. Sewer rehabilitation improvements are expected to occur within three years. The remainder of the improvements would be expected to occur within five years. The City Department of Environmental Services and the State Department of Land and Natural Resources are currently negotiating to resolve wastewater facility financing and management issues.

Prioritization and phasing of the proposed wastewater facility improvements will be critical to ensure that limited funds are expended in a manner that will produce the greatest benefit to the community and the environment. A recommended implementation priority list of the proposed wastewater facility improvements is shown on Table 1-2. High priority should be given to upgrade of the Waimanalo WWTP and reduction of excessive wet-weather infiltration and inflow.

SUMMARY OF DIFFERENCES BETWEEN THE PROPOSED ACTIONS OF THE 1984 AND CURRENT WASTEWATER FACILITIES PLANS

The current wastewater facilities plan projects a 1.1 mgd (year 2020) average daily wastewater flow that is substantially higher than the 0.7 mgd (year 2005) wastewater flow projected by the 1984 facilities plan. As a result, the current facilities plan

proposes substantially more extensive upgrades at the Waimanalo WWTP. The current facilities plan proposes less extensive expansion of sewers into coastal areas served by individual wastewater systems due to high costs and uncertain benefits. Development in other areas not anticipated by the 1984 plan, however, is projected. A summary of the differences between the proposed actions for the 1984 and current wastewater facilities plans are presented in Table 1-3.

**TABLE 1-2
RECOMMENDED IMPLEMENTATION PRIORITY LIST**

Priority	Action	Budget Cost	Rationale and Comments
High	Construct effluent filter system.	\$1,870,000 (funded by DLNR)	Improves plant performance and reduces potential injection well clogging problems. Construction to be completed in 1999.
High	Clean existing injection wells. Construct additional injection wells as required.	\$1,150,000 (3 new wells)	Minimizes potential for spills during high wet weather flows. Number of new wells to be determined based on the effectiveness of the well cleaning work and well capacity tests.
High	Investigate infiltration and inflow problems in western portion of the collection system and rehabilitate sewers as required.	\$650,000	Reduces the magnitude of peak flow which minimizes the potential for spills and improve treatment plant performance. Reduces need and cost for capital improvements to accommodate high peak flows.
High	Construct new anoxic-aerobic biological nutrient removal treatment units, final clarifiers and other related improvements. Construct <i>dissolved air flotation (DAF)</i> sludge thickener facilities.	\$7,150,000	Increases plant performance, stability and capacity. Permits future planned developments to proceed and existing dwellings serviceable by sewers to connect. Reduces nitrate loading on coastal waters.
Moderate	Institute other treatment plant upgrade work such as septage receiving station, influent monitoring facilities, additional influent pump, sludge bed improvements, fire protection upgrade, flood protection, and support facilities.	\$4,150,000	Facilitates operation of treatment facilities and improves personnel safety and morale.
Moderate	Construct additional facilities to permit irrigation reuse of effluent, including chemical feed facilities, ultraviolet disinfection system and effluent pump station.	\$1,820,000	Permits reuse of effluent to conserve water resources, and reduces hydraulic loading on injection wells and nutrient loading on nearshore waters.
Moderate	Perform further investigations on impact of subsurface wastewater discharges on coastal waters and relative impact of other nutrient sources in Waimanalo.	\$150,000	Potential savings of \$5.8 million in sewer capital improvement costs. Potential funding available through the Kailua Bay Advisory Council.
Moderate to Low	Install variable frequency drives and new fire hydrant at the Kahawai Stream Wastewater Pump Station	\$250,000	Increases energy efficiency and reliability, and improves the level of fire protection.
Moderate to Low	Implement beach lot area Sewer Improvement District No. 2 (if further studies recommended above indicate water quality benefits will be realized)	\$5,760,000	Reduces nitrate and other pollutant loading on nearshore waters. Eliminates public health concerns with malfunctioning individual wastewater systems.

**TABLE 1-3
COMPARISON OF 1984 AND CURRENT
WAIMANALO WASTEWATER FACILITIES PLAN**

ITEM	1984 FACILITIES PLAN	CURRENT FACILITIES PLAN	COMMENTS
POPULATION AND FLOWS			
<ul style="list-style-type: none"> ▪ Estimated Total Existing Population 	10,600 (1995 estimate based on 208 Water Quality Plan and Series IIF projections)	9,400 (1995 City Planning Dept. estimate based on 1990 census)	
<ul style="list-style-type: none"> ▪ Estimated Existing Sewered Population 	8,630 (81% of population)	6,130 (65% of population)	
<ul style="list-style-type: none"> ▪ Estimated Total Future Population 	12,000 (year 2005)	10,070 (year 2020)	See discussions in Chapter 3 for basis of estimate.
<ul style="list-style-type: none"> ▪ Estimated Future Sewered Population 	8,730 (year 2005)	9,280 (year 2020)	
<ul style="list-style-type: none"> ▪ Estimated Future Homes Sewered 	2,120 (year 2005)	2,240 (year 2020)	
<ul style="list-style-type: none"> ▪ Average Design Waimanalo WWTP Flow 	0.7 mgd (year 2005)	1.1 mgd (year 2020)	The per capita flow is substantially larger for the current facilities plan due to higher infiltration/inflow factor and non-domestic flows.
COLLECTION SYSTEM IMPROVEMENT PROJECTS			
<ul style="list-style-type: none"> ▪ Makapuu Interceptor Sewer Section 1 and 2 and Sewer Improvement District No. 4 	Proposed	Project Completed	
<ul style="list-style-type: none"> ▪ Sewer Improvement District No. 2 	Proposed	Recommended (subject to findings of additional investigations)	Relatively high cost. Primary concern is nutrient discharge. Additional investigations recommended to verify water quality benefits.
<ul style="list-style-type: none"> ▪ Sewer Improvement District No. 3 and 5 	Proposed	Not Recommended	High cost due to need for pump station. Limited anticipated water quality benefits. Individual wastewater systems with nitrogen removal capability anticipated to be more cost effective if water quality is an issue.
<ul style="list-style-type: none"> ▪ Sewer rehabilitation upstream of Kahawai Stream WWPS 	Not Proposed	Proposed	Sewer and treatment plant capacity was not a concern in the 1984 facility plan due to the lower number of sewer connections and resulting limited infiltration/inflow at the time.
<ul style="list-style-type: none"> ▪ Miscellaneous Kahawai Stream WWPS improvements 	Not Proposed	Proposed	Routine maintenance and minor upgrade work.

**TABLE 1-3
COMPARISON OF 1984 AND CURRENT
WAIMANALO WASTEWATER FACILITIES PLAN (continued)**

ITEM	1984 FACILITIES PLAN	CURRENT FACILITIES PLAN	COMMENTS
WASTEWATER TREATMENT PLANT IMPROVEMENTS			
<ul style="list-style-type: none"> ▪ Septage receiving facilities 	Proposed	Proposed	Acceptance of only low strength septage is proposed to minimize impact on plant processes and costly septage handling facilities. High strength septage to be treated at the Kailua Regional WWTP.
<ul style="list-style-type: none"> ▪ Influent pump station modifications 	Not Proposed	Proposed	Installation of additional smaller influent pump is proposed to reduce hydraulic loading on the plant during non-peak periods.
<ul style="list-style-type: none"> ▪ Install air lift pumps in final clarifier 	Proposed	Work Completed	Existing final clarifiers to be abandoned or used for other purposes (flow equalization) upon construction of new clarifiers for new biological treatment system.
<ul style="list-style-type: none"> ▪ Equalization basin 	Proposed	Proposed	Lower priority since proposed upgrade of biological treatment units will decrease need for equalization basin.
<ul style="list-style-type: none"> ▪ Influent sampling station 	Not Proposed	Proposed	Recommended to allow representative sampling of influent wastewater.
<ul style="list-style-type: none"> ▪ New anoxic-aerobic activated sludge biological treatment system 	Not Proposed	Proposed	Replaces outdated existing system currently operating at capacity. New system will provide improved performance and reliability, and nitrogen removal capability.
<ul style="list-style-type: none"> ▪ Effluent filters 	Proposed	Proposed	Construction to begin in 1998 and to be completed in 1999.
<ul style="list-style-type: none"> ▪ Ultraviolet disinfection 	Not Proposed	Proposed	New technology to eliminate the use of hazardous chlorine gas. A sodium hypochlorite disinfection system is anticipated to be used during an interim period until effluent reuse by irrigation is instituted.
<ul style="list-style-type: none"> ▪ Injection wells 	Three Wells Proposed	Three Additional Wells Proposed	The three wells proposed in 1984 were constructed but have experienced clogging problems due to poor effluent quality.
<ul style="list-style-type: none"> ▪ Effluent reuse by irrigation 	Proposed	Proposed	Agricultural farm lots and Olomana Golf Links are major potential users of the reclaimed water. Significantly more stringent effluent quality requirement are currently applicable.
<ul style="list-style-type: none"> ▪ Dissolved Air Flotation (DAF) Thickener 	Proposed	Proposed	Required to thicken biological sludge from the activated sludge process to reduce its volume.
<ul style="list-style-type: none"> ▪ Sludge bed upgrades 	Not Proposed	Proposed	Sludge currently hauled to the Kailua Regional WWTP. Project will increase capacity and performance of sludge drying beds.
<ul style="list-style-type: none"> ▪ Sludge Composting 	Proposed	Not Proposed	Offsite processing for beneficial reuse is envisioned. Composting not recommended in Waimanalo due to odor and site flooding concerns.
<ul style="list-style-type: none"> ▪ Fire protection upgrade 	Not Proposed	Proposed	
<ul style="list-style-type: none"> ▪ Personnel/maintenance facilities 	Not Proposed	Proposed	

**TABLE 1-3
COMPARISON OF 1984 AND CURRENT
WAIMANALO WASTEWATER FACILITIES PLAN (continued)**

ITEM	1984 FACILITIES PLAN	CURRENT FACILITIES PLAN	COMMENTS
<ul style="list-style-type: none"> ▪ Flood proof buildings/components 	Not Proposed	Proposed	Recent flood study indicates that higher flood elevations may be established in the future for the site.
ESTIMATED CONSTRUCTION COSTS			
<ul style="list-style-type: none"> ▪ Collection system upgrade 	\$2,700,000 (1982 dollars) \$4,100,000 (1998 dollars)*	\$6,000,000 (1998 dollars)	Approximately \$1,800,000 (1982 dollars) of the collection system upgrades recommended in the 1984 Facility Plan has been implemented.
<ul style="list-style-type: none"> ▪ Treatment plant upgrade 	\$3,800,000 (1982 dollars) \$5,700,000 (1998 dollars)*	\$16,800,000 (1998 dollars)	The 1984 Facility Plan cost shown includes \$1.2 million (1982 dollars) for the regional composting facility. Of the 1984 Facility Plan recommendations, only construction of the three injection wells and miscellaneous upgrade of plant equipment have been completed.
<ul style="list-style-type: none"> ▪ Total 	\$5,300,000 (1982 dollars) \$9,800,000 (1988 dollars)*	\$22,800,000 (1998 dollars)	

*A 1.5 cost escalation factor between 1982 and 1998 was used based on the Engineering News Record (ENR) Building Cost Index. It should be noted that actual cost escalation factors in Hawaii may differ from those published in ENR.

Chapter 2

Alternatives to the Proposed Action

CHAPTER 2

ALTERNATIVES TO THE PROPOSED ACTION

INTRODUCTION

This chapter discusses the various wastewater management alternatives evaluated as part of the Waimanalo Wastewater Facilities Plan project. Alternative courses of action were considered for both the wastewater collection system and the Waimanalo Wastewater Treatment Plant (WWTP). The various alternatives were evaluated based on cost-effectiveness analyses that considered both *monetary* and non-monetary factors. *In this chapter, the term "cost" was generally used to refer to monetary costs.* Where applicable, engineering life-cycle cost analyses were based on a discount rate of 6 percent over a 20 year period.¹

In the comparative cost-benefit analyses presented in this chapter, it should be noted that there are also other "costs" that typically include any effects that are considered liabilities. "Opportunity costs" is the term used for the resultant exclusion of other activities or facilities that comes with implementation of a project. Examples of other "costs" include visual degradation, loss of recreational resources, and social and cultural impacts.

WASTEWATER COLLECTION SYSTEM ALTERNATIVES

Waimanalo's regional wastewater collection system is comprised of a network of gravity sewers, and the Kahawai Stream Wastewater Pump Station (WWPS) and force main. Main trunk sewers are located on the east and west side of the Waimanalo WWTP. The Kahawai Stream WWPS services the western end of the collection system. The general configuration of the collection system was shown previously on Figures 1-1, 1-2a and 1-2b in Chapter 1.

Evaluation of the collection system alternatives focused on: 1) sewer system capacity evaluations examining flow reductions through sewer rehabilitation versus construction of relief sewer lines, and 2) continued use of individual wastewater systems versus centralized wastewater collection and treatment systems.

¹The six percent discount rate is based on approximate revenue bond interest rates obtained from the Department of Wastewater Management. The State Revolving Fund (SRF) interest rate, which is substantially lower, was not used since SRF funding may not be available. Salvage values were assumed to be insignificant and were not included in the analyses.

Evaluation of Collection System Capacity Alternatives

The condition and performance of the sewer lines were evaluated based on the ability to convey the required volume of wastewater while: 1) minimizing infiltration and inflow of stormwater during heavy rain, and 2) minimizing exfiltration and spillage of wastewater. Wet weather Infiltration and inflow (WWI/I) is typically the most significant concern. Excessive amounts of WWI/I may result in substantially increased flows that may result in wastewater spills and adverse impacts to wastewater treatment plant performance.

Flow projections and hydraulic capacity analyses indicated that capacity is a concern primarily on the western side of collection system. Future development of homes by DHHL and others will place additional strain on the collection system during periods of wet weather.

Alternatives considered to address the hydraulic capacity concerns in the west basin include the following:

- Alternative 1 - Do Nothing Alternative: This alternative would involve taking no action to either increase the system capacity or reduce wet-weather wastewater flows. As a result, there may be periodic wastewater spills and/or moratorium on future development in the west service area. The costs associated with this alternative included typical collection system maintenance costs and an assumed additional \$40,000 per year average cost for cleaning up, investigating and reporting spills. For the purposes of the cost analysis, it was assumed that the frequency and magnitude of the spills would be relatively low such that fines would not be levied by the State Department of Health (DOH).² In reality, there is a potential for large fines to be levied by DOH as well as the threat of lawsuits under the Clean Water Act.
- Alternative 2 - Perform Sewer Rehabilitation: This alternative would involve conducting a detailed Sewer System Evaluation Study (SSES) and implementing collection system rehabilitation measures to reduce WWI/I and lower peak flows to meet collection system capacity limitations. The focus of the rehabilitation work would be in the area upstream of the Kahawai Stream WWPS (see Figure 1-2a). For analysis, it was assumed that 1,500 feet of sewers would be rehabilitated or replaced at an estimated cost of \$0.45

²This assumption is considered reasonable due to: 1) the conservative nature of the design flow projections, and 2) the lack of actual recorded spills in this portion of the service area due to inadequate sewer capacity.

million. In addition to the cost of performing the actual rehabilitation work, costs associated with this alternative would include the engineering investigations to identify sewer rehabilitation methods and requirements. The cost of this alternative, which could vary depending on the work required, was based on reasonably conservative assumptions. The rehabilitation work is expected to reduce the WWI/I by at least 2.0 million gallons per day (mgd) (*from 5.0 mgd to 3.0 mgd*) during a storm with a five-year recurrence interval.

- Alternative 3 - Increase System Capacity: This alternative would involve construction of a relief sewer to provide the necessary increase in capacity to meet projected future peak design flows. Under this alternative, the construction of a 6,200 feet long 18" relief line at an estimated cost of \$4.96 million is proposed to be implemented in lieu of sewer rehabilitation. This alternative would also require upgrade of the Kahawai Stream Wastewater Pump Station (WWPS) and Waimanalo WWTP to increase the peak flow handling capacity of the facilities. The improvements to these facilities are estimated to cost \$1.1 million.

The above alternatives were evaluated based on costs (capital, annual operation and maintenance, and present worth costs) and non-monetary factors such as performance and reliability, public health protection, water quality protection, impacts during construction, and time for implementation. A comparative summary of the costs and non-monetary factors is presented in Table 2-1.

The recommended course of action is Alternative 2, the alternative involving the reduction of WWI/I. Reduction of WWI/I is anticipated to be especially cost-effective in Waimanalo since flow monitoring investigations indicate that the majority of the WWI/I is being generated within a relatively small service area (Fukunaga & Associates, 1995). The WWI/I inflow may be concentrated at a major inflow point such as a defective manhole in a low lying area or an illicit area drain connection. In the event that the WWI/I is distributed throughout the service area, the small size of the suspected basin would ensure that this alternative would be relatively cost-effective even if extensive rehabilitation and/or reconstruction of sewer lines and house laterals were required. The decision to rehabilitate the sewers is not highly sensitive to the extent of rehabilitation work needed due to the substantially higher cost of constructing a new relief sewer line.

The implementation of Alternative 1, the "do nothing" alternative, is not recommended due to significant concerns related to adverse impacts associated with potential wastewater spills. Spills from wastewater conveyance systems have the potential for causing public health impacts and adverse impacts on streams and coastal waters.

**TABLE 2-1
COMPARISON SUMMARY OF CAPACITY REMEDIATION ALTERNATIVES**

	1 - No Action Alternative	2 - Perform Sewer Rehabilitation	3 - Increase System Capacity
Costs¹	Capital: \$0 Annual maintenance: \$245,000 Present worth: \$2,810,000 Annualized cost: \$255,000 Annualized cost per Kgal average flow \$0.61 Annualized cost per household \$101	Capital: \$650,000 Annual maintenance: \$205,000 Present worth: \$3,000,000 Annualized cost: \$260,000 Annualized cost per Kgal average flow \$0.65 Annualized cost per household \$108	Capital: \$6,080,000 Annual maintenance: \$221,000 Present worth: \$8,610,000 Annualized cost: \$751,000 Annualized cost per Kgal average flow \$1.87 Annualized cost per household \$310
Performance and Reliability	<p><u>Poor</u> - Will not resolve capacity concerns and periodic spills from excess WWI/I may occur. Sewer surcharging and exfiltration will also remain a concern. Potential for DOH fines, litigation, and adverse publicity.</p> <p>May result in sewer connection moratorium and prevent construction of proposed new developments.</p>	<p><u>Excellent</u> - Will be capable of resolving capacity problems provided that rehabilitation work is well planned and properly performed to correct defects.</p>	<p><u>Excellent</u> - Will be capable of resolving capacity problems.</p>
Public Health and Water Quality Protection	<p><u>Poor</u> - Periodic wastewater spills and exfiltration may result in public health hazards and contribute to water quality degradation, particularly during wet weather when the effects of such impacts may be of greatest concern. <i>Beach closures may be required following a wastewater spill.</i></p>	<p><u>Excellent</u> - Will be capable of resolving concerns with wastewater spills and exfiltration. <i>Reduces public health hazards within recreational waters and minimizes potential need for beach closures.</i></p>	<p><u>Excellent</u> - Will be capable of resolving concerns with wastewater spills and exfiltration. <i>Reduces public health hazards within recreational waters and minimizes potential need for beach closures.</i></p>
Construction and Social Impacts	<p><u>None</u> - No major construction work is required. <i>No nuisance impacts (noise, odors, dust); visual degradation; impacts to archeological, historical and cultural resources; and other social impacts related to construction.</i></p>	<p><u>Moderate to High</u> - Impacts depend on number, type and location of sewer deficiencies. Significant potential impacts such as noise and dust to residential areas and private property. <i>Short-term visual impacts during construction. Generally limited potential impacts to archeological and cultural impacts due to construction primarily in areas with existing utility lines.</i></p>	<p><u>Very High</u> - Construction will occur along a major thoroughfare. Excavation area will be large due to depth of sewer. Dust, noise and traffic congestion will be significant. <i>Significant short-term visual impacts during construction. Some potential impacts to archeological and cultural impacts due to likely construction in new areas without existing utility lines.</i></p>

**TABLE 2-1
COMPARISON SUMMARY OF CAPACITY REMEDIATION ALTERNATIVES
(continued)**

	1 - No Action Alternative	2 - Perform Sewer Rehabilitation	3 - Increase System Capacity
Implementation Timeframe	<u>Not applicable</u> - No actions are proposed.	<u>One to four years</u> - Implementation timeframe depends on number, type and location of sewer deficiencies. Engineering study required prior to design and construction. Extent of sewer rehabilitation may be significant.	<u>Three to five or more years</u> - Project will require major design effort, securing of funds, and preparation of environmental permit documents. Wastewater pump station and treatment plant upgrade required.

Note: 1. Present worth is based on 20 year life, 6 percent discount rate and no salvage value. Annual unit costs shown are based on 1.1 mgd average flow and 2,420 households.

High wet weather peak flows also have an adverse impact on the performance of the Waimanalo WWTP.

Alternative 3, involving the increase of capacity through the construction of a relief sewer and improvements to the treatment plant and pump station, is clearly less cost-effective than the recommended alternative. In addition to being substantially more costly, this alternative also has significant non-monetary impacts such as major construction impacts. The construction impacts are anticipated to be significant due to the depth of the relief sewer required and its location along the heavily travelled Kalaniana'ole Highway.

It should be noted that other supplemental low-cost programs to further minimize wastewater collection system capacity may also be implemented. These include water conservation programs, programs to educate the public on illicit drain connections to sewers, and plumbing code inspection and enforcement programs.

Evaluation of Collection System Service Area Expansion Alternatives

Most future developments in Waimanalo are anticipated to be serviced by expansions to the wastewater collection system. The cost of constructing the new expanded portions of the collection system servicing the new projects are expected to be borne by the developers.

The alternatives pertaining to collection system expansion discussed below are associated with providing sewer service to existing coastal area homes that are currently served by individual wastewater systems (cesspools and septic tank systems). Many of the affected residents are opposed to sewerage of these areas due to cost. Many of the residents also feel that the individual wastewater systems are not adversely impacting public health and water quality.³

As discussed later in Chapter 5, pathogens and microbial contaminants originating from individual wastewater systems do not appear to have significant water quality impacts on Waimanalo's coastal recreational waters. Individual wastewater systems in the coastal areas of Waimanalo are also not a major concern from the standpoint of spills from overloaded systems due to the high percolation rates in the sandy soils. The problems with system overloads that do occur can be minimized if the systems are properly maintained, expanded, rehabilitated or replaced as required.

³Residents' opinions are from a mail-out survey that was conducted as part of the Waimanalo Facilities Plan. Forty-four percent of the approximately 400 households surveyed responded to the survey. See discussions in Chapter 10.

The contribution of nutrients from individual wastewater systems, however, is a potential concern. As discussed in greater detail in Chapter 5, findings based on both literature reviews and field studies conducted for this study indicate that soluble nitrates generated from organic and ammonia nitrogen in the wastewater are entering Waimanalo Bay near the coastline. It is uncertain whether the contribution of nutrients from individual wastewater systems is the primary cause of algal blooms that are known to occur in the coastal waters. Waimanalo has many other sources of nitrogen including agricultural fertilizers, livestock manure, and natural decay of vegetation.

The following discussion evaluates the costs and nonmonetary factors associated with sewerage and not sewerage the existing residences in the coastal areas. These areas, shown previously on Figure 1-2b, are the "beach lot" area (Sewer Improvement District 2) and the Bell Street area (Sewer Improvement District 3 and 5). The alternatives examined include:

- Alternative 4a - Individual Wastewater Systems for Beach Lot Improvement District: This alternative would involve not sewerage the homes in the beach lot area Sewer Improvement District 2. The homeowners would be required to upgrade existing failing or overloaded systems as required by DOH to minimize potential spills. The cost of this alternative includes estimated system upgrade costs and costs associated with pumping and treating the septage from the individual wastewater systems
- Alternative 4b - Individual Wastewater Systems for Bell Street Area Improvement District: This alternative would involve not sewerage the DHHL homes in Sewer Improvement District 5 and private beachfront homes in Sewer Improvement District 3 in the Bell Street area. As in the above alternative, homeowners would be required to upgrade failing individual wastewater systems.
- Alternative 5a - Sewer Beach Lot Improvement District: This alternative would involve sewerage the Beach Lot area Improvement District 2. The wastewater would be conveyed by gravity sewers to the main trunk line and treated at the Waimanalo WWTP. The costs associated with this alternative would include the cost of the sewers, the cost to the homeowner to construct a house lateral to connect to the sewer, and the prorated capital and operating costs of treating and disposing of the wastewater.
- Alternative 5b - Sewer Bell Street Area Improvement Districts: This alternative would involve sewerage the homes in the Sewer Improvement District Nos. 3 and 5 in the Bell Street area. Construction of a new wastewater pump station would be required to service the area. The pump

station would discharge into the existing gravity collection system. The types of costs associated with this alternative would be similar to that of the beach lot sewerage alternative except that this alternative would have the added capital and operating costs of the pumping station.

The four alternatives were evaluated based on monetary and non-monetary factors. Costs for the sewerage alternatives were considered from the standpoint of total costs (including costs to be shared by other sewer system customers) as well as the "out of pocket" costs to the homeowner. A summary of the costs and nonmonetary factors is presented in Table 2-2.

The costs associated with the individual wastewater system alternative for the Beach Lot area were estimated based on typical installation costs, and the following conservative system upgrade scenario assuming a "moderate" DOH policy where not all cesspools would require replacement:

System Upgrade	No. of Systems	Estimated Cost	Total Cost
New system (upgrade to septic tank system)	30	\$12,000	\$360,000
System expansion (new supplemental absorption trenches or beds)	70	\$4,000	\$280,000
No upgrade required	250	\$0	\$0
TOTAL	350	--	\$640,000

The average capital cost per home based on the above assumptions is \$1,830 per system. This average cost was used for evaluation and comparison purposes in this study. The actual cost to individual homeowners would vary from zero for an adequate system up to an estimated \$12,000 for a new system. Those homeowners requiring new systems would be faced with a heavy financial burden and it is anticipated that many homeowners would not be able to afford the a new system. Similar methods and assumptions were used to derive the average capital cost per individual wastewater system for *the* Bell Street area. The average cost for maintaining an individual wastewater system is assumed to be \$300 per year for maintenance pumping and treatment/disposal of the septage.

The estimated average cost of sewerage to the residents includes the following components:

**TABLE 2-2
COMPARISON SUMMARY OF INDIVIDUAL WASTEWATER SYSTEM
AND CENTRALIZED WASTEWATER COLLECTION AND TREATMENT ALTERNATIVES**

Cost ¹	Alternative 4a and 4b - Individual Wastewater Systems		Alternative 5a and 5b - Sewer Improvement Districts	
	Cost per Dwelling (homeowner expenses/cost per dwelling)		Cost per Dwelling (homeowner expenses/cost per dwelling)	
	Typical Average Costs (average of existing/new/modified)	Typical Worst Case Cost (new system)	Alternative 5a - Beach Lot Area (Sewer I.D. 2)	Alternative 5b - Bell St. Area (Sewer I.D. 3 & 5)
	Capital: \$1,830 to \$2,000 Annual Maintenance: \$300 Annualized cost: \$460 to \$470	Capital: \$12,000 Annual Maintenance: \$300 Annualized cost: \$1,350	Capital: \$6,500 Annual Maintenance: \$408 Annualized cost: \$980	Capital: \$6,500 Annual Maintenance: \$408 Annualized cost: \$980
	Total Cost of Alternative		Total Cost of Alternative	
	Alternative 4a - Beach Lot Area (Sewer I.D. 2)	Alternative 4b - Bell Street Area (Sewer 3 & 5)	Alternative 5a - Beach Lot Area (Sewer I.D. 2)	Alternative 5b - Bell St. Area (Sewer I.D. 3 & 5)
	Capital: \$640,000 Annual Maintenance: \$106,000 Annualized cost: \$162,000 Annualized cost/home: \$460	Capital: \$200,000 Annual Maintenance: \$30,000 Annualized cost: \$47,000 Annualized cost/home: \$470	Capital: \$7,160,000 Annual Maintenance: \$110,000 Annualized cost: \$734,000 Annualized cost/home: \$2,100	Capital: \$5,990,000 Annual Maintenance: \$130,000 Annualized cost: \$652,000 Annualized cost/home: \$6,500
Public Health Risk	Probable minimal risk provided that systems are adequately sized and properly maintained. May result in overflow of wastewater during heavy rain and flood conditions which will increase public health risks within recreational waters and may result in beach closures.		Minimal risk with proper design and maintenance. Future improvements should minimize risk of wastewater spills and overflows. <i>Public health risks within recreational waters and the potential for beach closures will be minimized.</i>	
Water Quality	Discharge of nitrates to groundwater and coastal waters is a potential concern and possible cause of algal blooms.		Reduction in nitrate discharge to groundwater and possible associated reduction in occurrence of algal blooms. Reduction in injection well nitrate discharge provided future upgrade to the Waimanalo WWTP includes nitrogen removal processes.	
Homeowner Attention	Requires homeowner attention due to requirement for periodic pumping of sludge for routine maintenance or for overload conditions. Homeowner must be aware of water usage and loading.		No significant attention required other than paying monthly wastewater fees.	
Water Reuse	Some homeowners may be using graywater for irrigation. This unregulated practice, however, may be resulting in some public health risks.		Treated effluent meeting regulatory requirements would be available for irrigation reuse following upgrade of the Waimanalo WWTP.	
Energy Consumption	Very low energy usage as energy primarily only required for hauling and treating sludge.		High energy usage for wastewater pumping and treatment.	
Construction and Social Impacts	Minor short-term nuisance construction impacts (noise, odors, dust) and visual impacts for upgrading individual wastewater systems. Limited potential for adverse archeological, historical, and cultural resources impacts due to limited excavation work.		Substantial short-term nuisance construction impacts (noise, odors, dust) and visual impacts due to new sewer construction. Greater potential for adverse archeological, historical, and cultural resources impacts due to more extensive excavation work.	
Administrative/Regulatory Requirements	Requires considerable regulatory effort by Dept. of Health to ensure systems are properly designed, constructed and operated. Spills and complaints must be investigated and enforcement action may be required.		Additional regulatory burden is minimal since effort already required for existing system and flows.	

Note: 1. Present worth is based on 20 year life, 6 percent discount rate and no salvage value. Annual unit costs shown are based on 350 households for Sewer Improvement Districts No. 2 and 100 households for Sewer Improvement Districts Nos. 3 and 5. See discussion on basis of capital costs for upgrading the individual wastewater systems in Alternatives 4a and 4b.

- An estimated \$4,000 for sewer contractor to install a sewer lateral on private property and fill the existing cesspool.
- Improvement district assessment charge of \$2,500 based on current City and County of Honolulu \$0.25 per square foot charge on a maximum of 10,000 square feet parcel size for parcels with R-10 zoning.⁴
- Average sewer fees of \$34 per month based on current rates.

The capital cost items for sewerage are therefore estimated to be \$6,500 for the sewer lateral installation and the one time assessment fee. The annualized cost of the sewer system capital cost of \$6,500 amortized over 20 years at an interest rate of 6 percent is approximately \$570. Together with the *current* typical sewer charges of \$408 per year, the estimated average total annual cost to the homeowner for the sewerage alternatives is approximately \$980.

The true cost of the system on a per dwelling basis, however, is considerably higher than the \$980 since the cost of the improvements in Waimanalo will be shared among other sewer system customers on Oahu.⁵ The cost of wastewater treatment is higher in Waimanalo than most other areas of Oahu due to the high level of treatment at the Waimanalo WWTP and the lack of "economy of scale" for the small system. If all the "true" costs to the homeowner and the City are considered, the annual cost per dwelling is estimated to be \$2,100 for the Beach Lot area and \$6,500 for the Bell Street area (see Table 2-2).

The analysis shows that on average, the annual cost of installing sewers is estimated to be approximately 4.5 and 13 times higher than the cost of remaining on individual wastewater systems for the Beach Lot and Bell Street areas, respectively. Obviously, there will be wide differences in the cost that any particular individual wastewater system owner will pay depending on the system's condition, loading and performance. Sewerage costs to the homeowner may also vary depending on lot size, sewer lateral length and water consumption rates.

If individual wastewater systems were not resulting in significant water quality problems, the continued use of these systems with required upgrading would be

⁴The improvement district assessment charge is based on the zoning lot size where the lot is larger than the zoning lot size. There are a small number of number parcels zoned R-7.5 in the Section 5 Improvement District which would have a assessment charge of \$1,875 for a 7,500 square foot or larger parcel.

⁵The City and County of Honolulu operates all its wastewater facilities as a single system from a cost recovery standpoint. A single common sewer fee structure applies to all wastewater system customers, regardless of their geographic location.

significantly more cost-effective than the sewerage alternative. In this limited analysis, it is difficult to determine the economic value associated with improvements to water quality resulting from eliminating the use of individual wastewater systems. Uncertainties associated with the impact of nutrients from the individual wastewater systems on coastal water quality should be resolved by conducting additional studies. It is recommended that a comprehensive watershed study be conducted to further identify and quantify the nitrogen loading on the coastal environment. It may also be desirable to investigate the frequency, causes, and other aspects of the algal blooms in Waimanalo. Nonpoint sources of pollution are suspected to be significant contributors of nutrients due to extensive agricultural activities in Waimanalo. Additional studies may potentially be funded by the Kailua Advisory Bay Council utilizing funds that were derived from settlement of a lawsuit involving the Kailua Wastewater Treatment Plant.

It can be concluded that sewerage the Beach Lot area would be significantly more cost-effective than sewerage the Bell Street area. The cost per home to sewer the Bell Street area is extremely high due to the relatively small number of homes and high cost of constructing the wastewater pump station. Eliminating the lower volume of wastewater discharge from individual wastewater systems in the Bell Street area would result in less potential beneficial impacts on water quality than eliminating the larger wastewater flow of the Beach Lot area.

Due to the high cost of sewerage the Bell Street area homes, several other options were briefly examined in the event that nutrient discharges were indeed found to be a problem. These options are listed and briefly evaluated below:

- Individual Wastewater Systems with Nutrient Removal Capability: Construction of individual wastewater systems with nitrogen removal capabilities with provisions for a maintenance contractor may be potentially cost-effective. The capital cost of a small treatment system with nitrogen removal capability should not be significantly higher than a conventional septic tank system. Operating costs for these systems, however, would be higher. At an assumed capital cost of \$15,000 per home and \$800/year for system maintenance and sludge disposal, the annual cost per dwelling is \$2,400 per home. This compares to \$6,500 per home for the conventional sewer and pump station alternative. Under this scenario, it is anticipated that DOH would impose the requirement for installing an individual wastewater system with nutrient removal capabilities and provide regulatory and enforcement oversight for proper system operation and maintenance.
- Low Pressure Sewer: A low pressure sewer system alternative would consist of a small pumping station (grinder pump, or septic tank with effluent

pump) at each home and a network of shallow force mains. Based on an estimated capital cost of \$2.8 million and \$700/year maintenance and wastewater treatment cost, the annual cost per dwelling is \$3,100.⁶ Some of the disadvantages of using low pressure sewer systems in Waimanalo include:

- Probable lack of maintenance attention by homeowners and difficulty among homeowners in identifying type of service required for malfunctioning systems (blockages vs. mechanical failures),
- Potential odors due to septic conditions in force mains,
- Potential need for air release valves that require maintenance and may cause wastewater spills due to malfunctions,
- Probable accelerated corrosion of metal and electrical components due to exposure to salt air,
- Probable accelerated wearing of pumps due to high grit content of the wastewater (sandy soil and heavy use of nearby beaches), and
- Shallow pipes subject to damage.

Pierce County located in the state of Washington has utilized low pressure sewers since 1983 and currently has approximately 900 homes serviced by these systems. In an interview conducted by the Department of Design and Construction (Leong, 1997), personnel from Pierce County recommended utilizing conventional gravity sewers, pump stations and force mains where possible due to the high maintenance requirements of low pressure systems, particularly as the system ages. *The primary advantage of low pressure sewer systems is the significantly lower capital cost.*

- **Submersible Pump Station:** Due to the relatively small service area, the use of a lower cost submersible pump station may be appropriate in lieu of a standard drywell/wetwell type pump station. Installation of submersible pumps directly in a wetwell may potentially reduce capital costs by an estimated \$1.8 million. This would reduce the annualized cost from \$6,500 to \$4,900 per dwelling. Submersible pumps have increased in reliability over

⁶Capital cost is based on \$15,000 per home for pumps, backup storage tank and lateral; 8,500 linear ft. of force main at \$100/ft. and \$420,000 for prorata treatment plant capital costs. Maintenance cost is estimated at \$300 per year and wastewater treatment cost is estimated at \$400 per year.

the years and are becoming more widely accepted in Hawaii and throughout the U.S. mainland. Disadvantages include not being able to observe the submerged pump in operation and possible leakage into the submerged motor housing.

Operations personnel from the City Department of Environmental Services indicated that dry-pit type pump stations are strongly preferred over submersible pump stations. The City has not permitted the installation of submersible pump stations to date as permanent primary pumping facilities but may potentially allow them to be installed on a case-by-case basis in the future.

For fiscal and general facility planning purposes, it would be prudent to assume that sewerage of the Beach Lot area, if required, would occur at some time in the future when the water quality issue is resolved. It is recommended that sewerage of the Bell Street area not be given further consideration due to the very high projected per dwelling costs and the potential feasibility of utilizing individual wastewater systems with nutrient removal capability if necessary. The results of a resident survey indicate that the majority of the residents oppose the installation of sewers (see discussions in Chapter 10). The decision to sewer the improvement districts, however, will ultimately rest on the City administration, DOH officials, and the City Council.

WASTEWATER TREATMENT PLANT ALTERNATIVES

The evaluation of treatment process alternatives was a major focus of the Waimanalo Wastewater Facilities Plan. Detailed evaluations were conducted for the various unit treatment processes. The following discussions describe the evaluations conducted for the major process areas in which the selection of alternatives could have substantial ramifications with respect to costs and environmental impacts. These process areas include the biological treatment system, effluent disinfection, effluent disposal, and sludge handling.

Other process evaluations were conducted in the facilities plan but are not discussed in this document because the associated environmental impacts were not considered significant. Examples of these evaluations include the need and sizing of flow equalization facilities; number and shape of clarifier tanks; type of effluent filters; and sludge thickening, pumping and dewatering options.

Evaluation of Biological Treatment Alternatives

Secondary level biological treatment is provided at the Waimanalo WWTP through the "Rapid Bloc" activated sludge process. The process was marketed by the Chicago Pump Company in the 1960's and is considered outdated technology based on current

industry standards. The Rapid Bloc system is currently operating at capacity and experiencing unstable performance that results in periodic effluent violations and accelerated clogging of the injection wells. The system requires an extensive amount of operating effort and attention.

Major upgrade of the biological treatment at the Waimanalo WWTP is required to adequately accommodate projected future flows. Replacement of the existing "Rapid Bloc" system presents the opportunity to employ more current treatment technologies that exhibit higher performance, increased reliability and/or reduced energy consumption.

The "no action" alternative is not considered a viable option due to current problems with the system, need for additional capacity to accommodate the planned growth, and water quality and public health concerns. Inaction to upgrade the treatment plant would place a long-term moratorium on new sewer connections and hinder development. The beneficial impacts of upgrading the treatment facilities and the concerns associated with individual wastewater systems are discussed in greater detail in Chapter 5.

The following discussions describe and evaluate alternative liquid stream processes that are potentially viable options for the Waimanalo WWTP upgrade. The basic treatment objectives are as follows:

- Effluent quality of 10 mg/l BOD₅ (five-day biochemical oxygen demand) and suspended solids (monthly average).
- Effluent quality of less than 8 mg/l-N total nitrogen (monthly average).
- Stable process performance that is not subject to frequent process upsets.

The effluent quality objectives were based on the use of injection wells and irrigation reuse for the disposal of effluent. These objectives were also selected based on typical performance limits of "practical" modern treatment processes that have been proven to be cost-effective. Nitrogen removal is proposed due to some concerns on discharge of nutrients into the groundwater. Many reclaimed water users also prefer low nitrate levels to allow them to better control the level and timing of nutrients applied to their crops.

Secondary treatment and nitrogen removal alternatives considered for the Waimanalo WWTP upgrade are described below:

■ Alternative 1 - Activated Sludge Without Nitrification-Denitrification

An alternative utilizing the activated sludge process without nitrogen removal was examined to serve as a basis of comparison with the other alternatives. The suspended growth activated sludge treatment system is a widely used and well-proven process. It can be designed to provide operating flexibility and, when operating properly, can provide excellent effluent quality. Since it is an aerobic process, odor generation is generally less than other processes. Some of the disadvantages and limitations of activated sludge systems include the following:

- Susceptibility to problems such as rising and bulking sludge and less resistance to shock loads and toxics than attached growth processes. Stability and performance are dependent on effective *settling* and return of the activated sludge.
- Skilled operators and considerable effort in process analyses are required for reliable performance.
- More energy intensive and generally higher maintenance costs than trickling filters and other similar attached growth processes.

Major advantages of the activated sludge process with respect to the Waimanalo WWTP expansion are as follows:

- Ability to incorporate existing process tankage into new facilities.
- Ability to design the system to handle high peak flow rates with modest increase in cost.
- Low head loss through the process (additional pumping of main flow not required).
- Low space requirements

■ Alternative 2 - Anoxic-Aerobic Activated Sludge with Nitrification/Denitrification

The activated sludge process may be specially configured to provide nitrogen removal through nitrification and denitrification. The anoxic-aerobic activated sludge process is a modified activated sludge system that provides biological nitrification and denitrification through the use of anoxic and aerobic process stages. This process requires no chemicals and shares the advantages

mentioned above for the activated sludge process. Other advantages of the anoxic aerobic process include:

- Relative simplicity of design and stable operation.
- Energy efficiency and recycle of alkalinity due to combined BOD removal/respiration and biological nitrate reduction.
- Improved sludge settleability due to "selector" design.

Some of the disadvantages include the requirement for slightly greater process tank volume and the need to maintain additional internal recycle pumps.

■ Alternative 3 - Oxidation Ditch with Nitrification/Denitrification

The oxidation ditch is a modification of the activated sludge process utilizing a "race track" type basin in which wastewater is aerated by a mechanical aerator/pumping device at one or more points. The oxidation ditch is potentially cost-effective when nitrification and denitrification are required since anoxic conditions can be created in portions of the flow circuit, or by turning the aerators off/on and providing only mixing.

Oxidation ditches are typically designed to operate in the extended aeration mode and therefore advantages of this process include good process stability, ease of operation, and production of a more stabilized sludge. The advantage of producing a more stabilized sludge is not as significant at the Waimanalo WWTP, however, due to the relatively large capacity of the existing anaerobic digesters.

Disadvantages of the oxidation ditch system include larger space requirements, higher tankage construction costs, and potentially higher energy consumption. With respect to nutrient removal, the disadvantage of the oxidation ditch is that the anoxic system is not staged (i.e., no plug flow through tank compartments). Lack of staging results in less efficient denitrification. At the Waimanalo WWTP, siting the oxidation ditch system near the existing aeration tanks may be difficult due to space limitations.

■ Alternative 4 - Sequencing Batch Reactor (SBR) with Combined Nitrification/Denitrification

The sequencing batch reactor (SBR) is a variation of the activated sludge *process* based on a fill and draw operation rather than a continuous flow

process. In the SBR process, a single reactor functions as an equalization tank, aeration basin, and clarifier. The curtailment of flow and aeration among the process tanks is used to provide quiescent batch settling of the activated sludge floc within the aeration tank. The SBR system exhibits many of the same advantages of other anoxic-aerobic type activated sludge processes. Some of the additional advantages of the SBR system include the following:

- Fewer number of process tanks and simplified plant piping due to multiple uses of the SBR reactor basins.
- Flexible operations due to capability to adjust time and/or aeration/mixing based on organic loads and flow conditions.
- Reactor basin serves as an equalization basin for both organic and hydraulic load peaking.
- Settling conditions are quiescent since there is no flow and no mechanical rakes for sludge collection.
- No clarifier mechanisms and return/recycle/scum pumps requiring maintenance and less extensive pump suction/discharge piping requirements.

Some of the disadvantages of the SBR system, some of which are specific to the Waimanalo WWTP, are as follows:

- Need for close operator attention, control and skill when used in the nitrification and denitrification mode as compared to the conventional activated sludge mode.
- Operation is dependent on a computer and motorized valves/gates for sequencing of process flows.
- Need for effluent equalization upstream of the filtration and disinfection facilities due to intermittent decanting of effluent flow at a high rate.
- Existing treatment tankage cannot be readily incorporated into the process.
- Potential difficulties in handling extreme peak flows (high peak flow decanting rate)

- Difficulty in providing positive scum removal from the large SBR reactor tanks.
 - Potentially larger tank volume requirements (aeration and effluent equalization) compared to anoxic-aerobic activated sludge (aeration and clarifiers).
 - Probable need for a primary effluent pumping station due to high head losses through the system.
- Alternative 5 - Trickling Filter/Solids Contact with Denitrification Filter and Methanol Addition

This alternative consists of the trickling filter process followed by a solids contact process. The trickling filter is a fixed film process that offers fairly stable performance and eliminates sludge bulking concerns typical of activated sludge processes. The existing aeration tanks may be used for the solids contact basin.

For removal of nitrogen, this process would be designed for nitrification to occur within the trickling filter. Denitrification could be achieved either by a denitrification filter or an anoxic stage in the solids contact stage. In either case, addition of methanol or alternative carbon source would be required.

Disadvantages of the process include:

- High cost and added operational skill and chemical handling/storage requirements for methanol or other carbon source addition for nitrogen removal.
- Greater difficulty in handling high hydraulic peaking factors without degradation of performance or increases in trickling filter size.
- Larger space requirements than activated sludge processes (except for oxidation ditch).
- Moderate process reliability due to potential uncontrolled biofilm sloughing or snail growth in the trickling filter that could affect nitrification.
- Need for primary effluent pumping station due to high head losses through the trickling filter.

Other fixed film biological systems that were briefly considered include: 1) the biological aerated filter (upflow or downflow), and 2) contact stabilization with downstream nitrification trickling filter and denitrification filter. These systems have disadvantages and limitations similar to the trickling filter/solids contact process and were therefore not considered in detail.

■ Alternative 6 - Low Technology Pond/Wetland Treatment System

Various low technology "natural" treatment systems were considered for Waimanalo as an alternative to the existing "concrete and steel" type facilities. These systems typically include various types of stabilization ponds and constructed wetlands type systems.

Stabilization ponds may either be non-aerated or aerated type. Non-aerated ponds, called facultative ponds, are typically lightly loaded ponds that rely on atmospheric reaeration and algal respiration to biologically treat the wastewater in the upper zone of the pond. Sludge that settles in the ponds is anaerobically digested and stored within the bottom portion of the ponds. Aerated lagoons are similar in concept to facultative ponds except that diffused air or mechanical aeration devices are used to supply oxygen to the ponds.

Wetlands are inundated land areas with water depths (typically less than four feet) that support various forms of aquatic vegetation. This vegetation provides surfaces for the attachment of bacterial films, aids in the filtration and adsorption of wastewater constituents, transfers oxygen into the water column and controls the growth of algae by restricting the penetration of sunlight. Both natural and constructed wetlands have been used for wastewater treatment.

The use of natural wetlands is generally limited to the polishing or further treatment of secondary or advanced treated effluent. From a regulatory standpoint, natural wetlands are usually considered receiving waters, requiring a National Pollutant Discharge Elimination System (NPDES) permit for any discharge to the wetland. The existing wetlands at Bellows AFS would not lend itself to effluent discharge to natural wetlands for polishing due to the limited extent of the wetlands.⁷ Constructed wetlands offer similar treatment capabilities of natural wetlands, but without the need for

⁷The wetlands at Bellows AFS consist of the banks along Inoaole and Waimanalo streams and scattered pools of standing water which support wetland vegetation and wildlife (Belt Collins Hawaii, 1995).

an NPDES permit. Constructed wetlands, however, are not disposal systems. The effluent must therefore be collected and disposed of in accordance with regulatory requirements.

The benefits of natural and low technology systems include low energy requirements, need for minimal operator skill, and creation of wildlife habitats. Disadvantages of these systems, including those specific to Waimanalo, are as follows:

- Very high land area requirements.
- Potential odor problems due to excessive loadings and sludge accumulation, decaying vegetation, and fish kills (if fish are used for mosquito control).
- Lower effluent quality with respect to BOD, suspended solids, nutrients and color (color due to organic acids may impact ultraviolet disinfection efficiency).
- Potential creation of a mosquito breeding habitat (pockets of water may be inaccessible to fish without extensive efforts to thin vegetation).
- Large area of ponds generates additional wastewater during heavy rains, and diversion of flood waters around the large ponds in the flat low lying areas of Waimanalo may be difficult and costly.
- Removal and disposal of accumulated sludge are eventually required and odors may be substantial during sludge removal operations.
- Vegetation is subject to diseases.
- Remote location from existing plant will require additional pumping and transmission lines to transport wastewater to and from the facility, which decreases process reliability, increases potential for spills, and consumes energy.
- Punctures or defects in pond liner may result in undetected discharge of wastewater to the groundwater.
- To achieve nutrient reduction, extensive labor is required for harvesting of vegetation, which must be disposed of at a landfill or further processed for beneficial reuse (composted).

Due to the limited land in Waimanalo, any pond alternative would require the use of an aerated stabilization pond. To provide basic secondary treatment of 1.1 mgd of primary effluent from the Waimanalo WWTP, an unaerated facultative pond system is estimated to require approximately 42 acres compared to only about 10 acres for an aerated pond. For effluent polishing and nutrient removal, it is estimated that an additional 19 acres of unaerated water hyacinth ponds will be required.

The biological treatment alternatives discussed above were compared and evaluated with respect to their cost-effectiveness. All the alternatives were configured to meet the high effluent quality and reliability requirements necessary for irrigation reuse of the effluent. All the alternatives, with the exception of Alternative 1, are provided with nitrogen removal capability.

Based on a preliminary screening of alternatives, the alternative involving the use of a SBR system (Alternative 4) was eliminated from further consideration. Although this alternative offered some advantages over the other activated sludge alternatives in terms of simplified flow routing (fewer tanks and plant piping), this alternative is not particularly well suited for the Waimanalo WWTP treatment system upgrade. The need for additional pumping of the main flow, difficulty in handling extreme peak wet weather flows, and lack of positive scum removal provisions are major disadvantages of the system. Costs are anticipated to be comparable to or higher than the other activated sludge systems due to: 1) the need for large process tanks (reactor tanks with an approximately 24-hour total hydraulic detention in addition to an effluent equalization basin), and 2) additional pumping facility to accommodate high head losses that are inherent to the process.

Also eliminated from further consideration was the trickling filter/solids contact alternative (Alternative 5). Fixed film treatment processes are not considered to be well suited for nutrient removal due to the need for chemicals (carbon source such as methanol) to achieve denitrification. This represents a significant added cost and increases the complexity of operations. Other significant disadvantages of fixed film process include potential difficulties in handling and treating the high wet-weather flows, greater potential for odor generation, and the need to pump the main flow due to high system head losses.

Two other alternatives that would normally not be considered further for the detailed evaluations are: 1) activated sludge without nitrification/denitrification (Alternative 1), and 2) low technology wetland system (Alternative 6). The activated sludge alternative was included in the evaluations to serve as a basis of comparison for the two other activated sludge alternatives (Alternatives 2 and 3). Alternative 6, involving the land intensive ponds/wetlands concept, was included in the evaluations for

comparison purposes due to the interest in low technology "natural" systems by community and environmental groups.

Alternatives 2 and 3, involving the anoxic/aerobic and oxidation ditch activated sludge technologies, respectively, were evaluated in detail. Both of these alternatives represent "state-of-the-art" technologies for small nutrient removal treatment systems. These two treatment systems are capable of producing high quality effluent, are relatively reliable, and do not require a high degree of operator skill.

A comparison of monetary and non-monetary factors for the four alternatives considered in detail is presented in Table 2-3.

The activated sludge alternative without nutrient removal (Alternative 1) is not recommended based on the inability to reduce effluent nitrate concentrations. In this study, the conventional activated sludge system was assumed to require more conservative design due to the susceptibility of these systems to severe bulking problems.

The low technology pond/wetland system (Alternative 6) is not considered to be cost-effective largely due to the large land area requirements. Unlike many U.S. mainland locations and some outer island locations, Waimanalo does not have a significant amount of surplus land that is far removed from populated areas. Land at the Bellows AFS, while potentially suitable for a land intensive low technology treatment process, has significant future value for residential development and other uses. The high cost of land, along with other potential concerns, such as odors, mosquito problems, and extensive influent/effluent pumping requirements, result in the pond/wetland alternative not being a highly cost-effective alternative. Furthermore, the quality of the effluent from pond/wetland systems is generally inferior to that of modern well designed and operated "concrete and steel" treatment systems. Although a pond/wetland system would have the significant benefit of creating additional wetland vegetation and wildlife habitats, it would do so at a relatively high cost and with some potential public health and water quality risks. If desired by the community, wetlands could be built in Waimanalo at a much lower cost by not incorporating it into a wastewater treatment scheme.

Based on the evaluation of costs and non-monetary factors, the anoxic-aerobic activated sludge (Alternative 2) and oxidation ditch (Alternative 3) processes were the two most cost-effective treatment upgrade alternatives. The oxidation ditch is projected to have a higher capital cost but lower operating cost than the anoxic-aerobic alternative. Based on a present worth cost analysis, the anoxic-aerobic system is projected to be on the order of \$70,000 per year lower in total annualized costs. Since the analysis is based on conservative "planning level" cost estimates,

**TABLE 2-3
COMPARISON SUMMARY OF BIOLOGICAL TREATMENT ALTERNATIVES**

Treatment Alternative	Costs ¹	Performance and Reliability	Operation and Maintenance	Energy Consumption	Land Requirements	Construction/Implementation	Environmental and Social Impacts
<u>Alternative 1</u> Conventional Activated Sludge	Capital Cost: \$5,830,000 Annual Maintenance Cost: \$330,000 Total Present Worth: \$9,640,000 Annualized Cost: \$841,000 Annualized Cost per Kgal Avg. Flow: \$2.10	Moderate - Generally high quality effluent possible. Subject to periodic bulking problems. Minimal nitrate removal.	Moderate - Bulking problems require operator attention. Requires maintenance of aeration equipment. Wide degree of process control possible (dissolved oxygen control, tankage scheme, etc.)	Good - Energy consumption can be reduced by minimizing nitrification.	Good - Slightly larger than anoxic-aerobic alternative.	Good - No major siting problems anticipated. Work is within treatment plant site boundaries. Some dewatering required for clarifiers.	Moderate - No removal of nitrates. Minimal odor problems. Moderate energy consumption. Limited nuisance impacts (noise, odors, dust) since construction is primarily limited to plant site. No adverse impacts to archeological, historical and cultural resources anticipated.
<u>Alternative 2</u> Anoxic-Aerobic Activated Sludge	Capital Cost: \$5,680,000 Annual Maintenance Cost: \$367,000 Total Present Worth: \$9,890,000 Annualized Cost: \$862,000 Annualized Cost per Kgal Avg. Flow: \$2.15	Excellent - Excellent (single digit) effluent anticipated. Anoxic selector will eliminate or minimize bulking problems. Nitrate removal possible.	Good - Operation expected to be stable due to lack of bulking problems. Requires maintenance of aeration equipment and internal recycle pump. Wide degree of process control possible (dissolved oxygen control, tankage scheme, etc.)	Good - Anoxic treatment utilizes nitrates in lieu of dissolved oxygen for BOD removal.	Good - Tankage size reduced due to use of existing aeration tanks for anoxic treatment.	Good - No major siting problems anticipated. Work is within treatment plant site boundaries. Some dewatering required for clarifiers.	Moderate - Removes nitrates to improve water quality and facilitate reuse. Minimal odor problems. Moderate energy consumption. Limited nuisance impacts (noise, odors, dust) since construction is primarily limited to plant site. No adverse impacts to archeological, historical and cultural resources anticipated.
<u>Alternative 3</u> Oxidation Ditch	Capital Cost: \$6,988,000 Annual Maintenance Cost: \$325,000 Total Present Worth: \$10,720,000 Annualized Cost: \$935,000 Annualized Cost per Kgal Avg. Flow: \$2.33	Excellent - Excellent (single digit) effluent anticipated. Anoxic selector will eliminate or minimize bulking problems. Nitrate removal possible.	Good - Operation expected to be stable due to lack of bulking problems and long detention time. Requires maintenance of aeration equipment and mixers. Produces partially stabilized sludge. More stable under varying flows and loads.	Good - Anoxic treatment utilizes nitrates in lieu of dissolved oxygen for BOD removal. Oxygen demand anticipated to be slightly lower than other activated sludge processes.	Satisfactory - Tanks will not fit near existing aeration tanks. Siting of the future oxidation ditch may present difficulties due to site constraints.	Good - No major siting problems anticipated. Work is within treatment plant site boundaries. Some dewatering required for clarifiers.	Moderate - Removes nitrates to improve water quality and facilitate reuse. Minimal odor problems. Higher energy consumption. Limited nuisance impacts (noise, odors, dust) since construction is primarily limited to plant site. No adverse impacts to archeological, historical and cultural resources anticipated.

**TABLE 2-3
COMPARISON SUMMARY OF BIOLOGICAL TREATMENT ALTERNATIVES (continued)**

Treatment Alternative	Costs ¹	Performance and Reliability	Operation and Maintenance	Energy Consumption	Land Requirements	Construction/Implementation	Environmental and Social Impacts
<u>Alternative 6</u> Ponds/Wetlands Treatment	Capital Cost: \$20,220,000 Annual Maintenance Cost: \$183,000 Total Present Worth: \$22,320,000 Annualized Cost: \$1,950,000 Annualized Cost per Kgal Avg. Flow \$4.86	Moderate to Poor - Double digit effluent expected but well within standards. Algae may be a potential problem. Dissolved organics (color) may reduce UV disinfection efficiency.	Good - Minimal process control required. Low skill labor required for hyacinth removal. Requires maintenance of aeration system and additional blowers. No sludge pumping required although requires future removal and handling of sludge.	Very Good - Low energy requirements for aeration. Additional energy required for pumping to and from site.	Poor - Extensive land requirements.	Poor - Major construction at new site is involved. Construction of force mains required along existing highways and streets.	<u>Moderate</u> - Removes nitrates to improve water quality but lower removal than mechanical processes. Potential odor problems. Low energy consumption. <i>Greater nuisance impacts (noise, odors, dust) since construction area is large and will be at a new site and along public right-of-way. Possible adverse impacts to archeological, historical and cultural resources depending on location of treatment site.</i> Creates wildlife habitat.

Note: Present worth is based on 20 year life, 6 percent discount rate and no salvage value. Annual unit costs shown are based on 1.1 mgd average flow.

it should be noted that the difference in costs between the two alternatives could potentially be larger or smaller.

Both alternatives have advantages and disadvantages in terms of non-monetary impacts. While both are capable of very reliable performance, the anoxic-aerobic process offers more process control flexibility due to the ability to vary the number of aeration compartments in use and the level of dissolved oxygen in each compartment. The oxidation ditch process, on the other hand, should be more stable under varying conditions due to its longer detention time. The oxidation ditch alternative, which is envisioned to ultimately consist of three 160 feet long by 50 feet wide tanks (two tanks for year 2020 flows), requires considerable land area. Accommodating all three tanks and final clarifiers in the existing open area along the west boundary of the site while meeting vehicle access requirements and hydraulic constraints may be difficult. From a solids handling standpoint, the oxidation ditch alternative is projected to produce a lower volume of a more stabilized sludge. The oxidation ditch is projected to produce on the order of 13 percent less sludge than the anoxic-aerobic process.

Based on an assessment of monetary and non-monetary factors, it is recommended that the anoxic-aerobic activated sludge system (Alternative 2) be utilized for the future upgrade of the Waimanalo WWTP. This recommendation is made on the basis of the alternative's anticipated lower capital and life-cycle costs, lower land area requirements, and the system's high degree of operating flexibility.

Evaluation of Effluent Disinfection Alternatives

Disinfection of the effluent is currently accomplished by a gas chlorination system. The gaseous chlorine is supplied by ton cylinders (one in-service and one spare). Chlorine gas is a highly toxic oxidant that may be fatal if inhaled in sufficient quantity. Exposure to chlorine at a concentration of 1,000 parts per million will result in fatalities in a very short exposure time. Liquid chlorine in contact with skin or eyes will cause burns. Chlorine will support combustion and will react with many inorganic and organic compounds, usually with the evolution of heat. At elevated temperatures, it reacts vigorously with most metals.

Fire code requirements that are currently applicable to hazardous gas systems such as chlorination are specified by the 1988 Uniform Fire Code (UFC). The 1988 UFC brought about more restrictive and specific requirements for the use of chlorine at treatment facilities. The UFC includes specific requirements for spill control, gas detection, and ventilation and treatment. Substantial upgrade of the existing chlorination facilities would be required to fully comply with the requirements of the 1988 UFC. In addition to upgrades to the existing facilities, continued use of chlorine

gas requires substantial administrative and operations manpower and effort for record keeping and safety programs.

The most recent 1994 version of the UFC has not yet been adopted by the City and County of Honolulu. The timeframe for adoption of the 1994 UFC is uncertain at this point in time. Based on a brief review of the 1994 UFC, the requirements for additional upgrades in facilities and procedures will not be as extensive as those associated with the 1988 UFC.

The existing chlorination facilities may potentially retain its "grandfathered" status, and exemptions to the code requirements may potentially be granted by the County Fire Chief. Non-compliance with the UFC, however, exposes the operating personnel and the surrounding community to risk, and the City to potential lawsuits, fines and adverse publicity, particularly if a major leak were to occur.

The operators at the Waimanalo WWTP and other City operations personnel have expressed a strong preference for eliminating the use of gaseous chlorine due to the inherent safety hazards and the availability of other means of disinfection. Numerous treatment facilities in Hawaii and on the mainland have abandoned the use of gaseous chlorine based on considerations involving safety, regulatory requirements, cost, and disinfection efficiency.

The Waimanalo Wastewater Facilities plan concluded that the existing gaseous chlorination system should be replaced with an alternative disinfection system. Safety is an overriding concern at the Waimanalo WWTP site due to the surrounding residential and commercial land uses. The City has already initiated a project to install new sodium hypochlorite solution chlorination equipment in the existing injection well compressor building to replace the gas chlorination system.

The future use of liquid sodium hypochlorite, granular calcium hypochlorite, and other onsite/offsite chlorine solution generation options was evaluated. Based on the evaluations, it was concluded that the hypochlorination would be appropriate for limited shock chlorination of the effluent or emergency disinfection (such as during spills). It would not, however, be desirable or cost-effective for continuous disinfection of the effluent under an irrigation reuse scheme. Hypochlorination has certain limitations, including cost, difficulties in handling and feeding the chemical, chemical and fire hazards, and loss of disinfectant potency with time. In its effluent reuse guidelines (DOH, 1993), DOH discourages the use of chlorination due to concerns regarding toxicity to aquatic life and formation of carcinogenic chlorinated hydrocarbons. The use of chlorination in an effluent reuse scheme would require the expansion of the existing chlorine contact tank.

The primary objective of disinfection is to reduce the concentration of pathogenic microorganisms. Pathogenic microorganisms found in wastewater include bacteria, viruses, cysts, and ova. Common disinfection processes include introducing chemical agents such as bromine, chlorine, and other members of the halogen group, ozone, or silver; irradiation with gamma waves or ultraviolet light; and physical means such as sonification, electrocution, or heating.

The DOH effluent reuse guidelines identify only chlorination and ultraviolet (UV) disinfection as the two acceptable disinfection methods for the production of reclaimed water. Based on this limitation and the inherent disadvantages of chlorination, the use of UV technology is proposed to disinfect the Waimanalo WWTP effluent in the future. Although other disinfection methods are potentially feasible, they would require additional effort to demonstrate satisfactory disinfection efficiency and reliability to DOH. Other wastewater disinfection methods are generally unproven, less economical, and unlikely to provide any major benefits over UV disinfection.

UV disinfection involves the reduction of microorganisms by causing damage to the cellular nucleic acids. This process involves applying low energy UV radiation to the reclaimed water. An array of mercury vapor lamps is used to produce ultraviolet light. The ultraviolet light penetrates the cell membrane or virus sheath and causes direct damage to the cellular nucleic acids. Injured organisms are either killed or are unable to reproduce.

A currently ongoing project to install a sodium hypochlorite disinfection system at the Waimanalo WWTP will provide an interim primary disinfection system until effluent reuse is implemented. Installation of a new UV disinfection system is proposed when other plant upgrades and offsite facilities are constructed for effluent reuse. The sodium hypochlorite system would then serve as a backup/supplemental disinfection system.

Evaluation of Effluent Disposal Alternatives

Alternative effluent disposal options were evaluated on the basis of costs, improving capacity, mitigation of water quality impacts, and utilizing effluent as a water resource. Effluent disposal alternatives considered for the Waimanalo WWTP upgrade are described below.

- **Alternative 1 - Effluent Disposal by Injection Wells**

There are seven existing injection wells at the Waimanalo WWTP that are used for disposal of the effluent and regulated under the DOH Underground Injection Control (UIC) program. One of the seven wells has collapsed and is proposed to be taken out of service. The locations of the existing and

proposed new wells were previously shown on Figure 1-3. The existing wells range in depth from 200 to 220 feet in depth and are solid cased in the upper portion of the well (varying between 67 and 108 feet) to permit discharge of effluent only through the bottom portion of the well.

This alternative proposes the use of injection wells as either the sole means of effluent disposal or as a full backup to effluent irrigation disposal. The alternative would involve installing additional wells and performing improvements to the existing wells to increase the available capacity.

The proposed new sand filters will result in high effluent quality that will minimize future clogging of the wells. The proposed WWTP anoxic selector activated sludge process will have the capability to remove much of the nitrogen from the effluent. This minimizes concerns associated with the discharge of nitrogen and the eutrophication of nearshore coastal waters.

■ Alternative 2 - Irrigation Reuse of Effluent

Reuse of wastewater effluent for irrigation has been successfully practiced in Hawaii and elsewhere, and has become an increasingly widespread means of effluent disposal.

Waimanalo is well suited for reclaimed water due to the low salinity of the wastewater, the need for water in the area, and the relatively close proximity of the potential users. Irrigation reuse would be a means of reducing the hydraulic and solids load on the Waimanalo WWTP injection wells.

The two primary reuse options that were examined in detail in the facilities plan are as follows:

- Alternative 2a - Irrigation of appropriate farm lots to supplement the existing Waimanalo irrigation system operated by the State Department of Agriculture (DOA).
- Alternative 2b - Irrigation of Olomana Golf Links which is currently using potable water supplied by the Board of Water (BWS) supply.

The locations of these and other irrigation sites were previously shown on Figure 1-4 along with the approximate configuration of the proposed transmission lines. Various other small potentially viable reuse sites exist throughout Waimanalo. Larger users of reclaimed water, however, are generally more adapted to the use of reclaimed water due to greater financial resources, availability of technical/administrative support, and economy of

scale. Small users may have a difficult time justifying the cost and manpower necessary to comply with the stringent regulatory and administrative requirements associated with use of reclaimed water.

The use of Waimanalo WWTP effluent for irrigation of crops in the agricultural areas of Waimanalo, as envisioned by Alternative 2a, was proposed in Final Watershed Plan and Environmental Impact Statement, Waimanalo Watershed (1981) by the U.S. Department of Agriculture Soil Conservation Service (lead agency) and the State DLNR. The watershed plan proposed that the effluent irrigation system consist of a separate independent irrigation reservoir, pump, and pipeline system that would not be directly interconnected with the existing Waimanalo Irrigation System. The State DOA has indicated that the state remains committed to the effluent reuse project. The DOA has authority under Chapter 167, HRS to serve as reclaimed water purveyor and would be responsible for the distribution and use of the water once it leaves the WWTP site.

As currently envisioned, the effluent irrigation infrastructure for the agricultural lots includes a 12-inch force main from an effluent pump station at the Waimanalo WWTP to a reservoir. The two-cell 3.5 million gallon reservoir is proposed to be constructed on State land at the Wing-King Reservoir site (TMK 4-01-26:03 and 04). The secondary effluent is proposed to be used to irrigate bananas, orchard crops, and certain nursery crops.

The State DOA estimates that the maximum daily delivery requirement to the reservoir is 1.0 mgd. The DOA provided estimates of the maximum monthly irrigation needs based on an analysis of rainfall, pan evaporation and crop growth. The average annual usage is estimated to be 0.18 mgd and the average usage during the driest month (June) is projected to be 0.36 mgd.

Alternative 2b proposes irrigation of the Olomana Golf Links, an eighteen-hole golf course located on the makai side of Kalaniana'ole Highway adjacent to Bellows AFS. The golf course, which encompasses approximately 130 acres, is approximately two miles west of the Waimanalo WWTP.

Under Alternative 2b, the proposed Olomana Golf Links Irrigation project would entail installation of a pumping station at the Waimanalo WWTP, approximately 10,000 feet of 8-inch force main, and a reservoir and irrigation pumping station at the golf course. Based the finding of a nonpotable water study for the Olomana Golf Links (CH2M-Hill, 1995) and discussions with golf course personnel, the golf course is estimated to require up to

approximately 0.5 mgd of water per day during dry periods. Following upgrade of the irrigation system and use of high irrigation rates, the average demand is estimated to be 0.13 mgd.

It is proposed that reclaimed water produced by the Waimanalo WWTP be of "R-1" quality as defined by DOH. This highest level of treatment will help ensure adequate protection of public health and result in minimal restrictions on the use of the water.

Irrigation reuse alternatives do have the major disadvantage of requiring a backup disposal alternative during periods of low demand during wet weather periods. Storage reservoirs will help minimize the extent of backup facilities required. Backup effluent disposal is also required in the event of inadequate treatment of the wastewater due to treatment process upsets or mechanical problems. Peak effluent flow will normally occur during wet weather when little or no irrigation is required. Degradation of effluent quality is also most likely to occur during this period due to high hydraulic loading on the process units. It would be prudent to require the backup disposal system to be capable of accommodating the projected design peak flow.

One major advantage of the irrigation alternatives is that the use of and reliance on alternative disposal methods such as injection wells would be reduced. If injection wells are used as the backup disposal method, the rate of clogging and associated reduction of capacity of the wells would be reduced. During periods of effluent reuse, some or all of the injection wells could "rest." These rest periods promote the physical, chemical and biological breakdown of accumulated effluent solids trapped in the interstitial spaces of the geological stratum. Rest periods and reduced usage of the wells should decrease the frequency and cost of cleaning the wells.

As indicated above, there may be periods due to such factors as plant upsets and mechanical problems that the effluent may not be of suitable quality for irrigation use. These occurrences should rarely occur with a well designed and maintained treatment facility. Alternate irrigation water supplies, however, will need to be available. The backup sources may also be used during dry months when reclaimed water may not be sufficient to meet the full demands of both the agricultural lots and Olomana Golf Links.

Implementing an effluent reuse alternative has the significant advantage of transforming the wastewater effluent from an environmental liability to a valuable resource. Unfortunately, this alternative requires considerable additional expenditure of funds for the additional infrastructure and monitoring/administrative costs. The projected cost of constructing and

operating additional facilities for the reclaimed water project, based on amortized capital costs and estimated annual operation and maintenance costs, is approximately \$4.50 per 1,000 gallons for the farm lot irrigation project. The estimated cost of the effluent is \$6.60 per 1,000 gallons for the Olomana Golf Links. The above costs include allowances for additional storage and water distribution facilities that are anticipated to be required.

Costs would need to be shared among the various entities. The emphasis will need to be on creating a "win-win" situation for all of the parties involved. In addition to DLNR and the City Department of Environmental Services (ENV), the Honolulu Board of Water Supply (BWS) also has an interest in promoting the use of reclaimed water. The City ENV is currently required to implement effluent reuse to satisfy the requirements of a Consent Decree. The BWS has an interest in conserving potable water for potable uses to minimize the development of new potable water sources. If the effluent reuse projects are well conceived and managed, the goals of each party may be satisfied. Reuse of effluent may not be warranted based solely on economics but may be justified on the basis of water quality benefits. These benefits, however, are not well defined at this point in time. The irrigation reuse recommendations and future reclaimed water projects in Waimanalo should be incorporated into the Oahu Water Management Plan and coordinated among the various entities involved in water resource planning.

- Alternative 3 - Rapid Infiltration Trenches or Ponds

Infiltration trenches or ponds were briefly investigated as an alternative method of effluent disposal in Waimanalo.⁸ These effluent infiltration systems would be primarily regulated by the DOH Chapter 62 regulations pertaining to wastewater disposal systems.

All forms of infiltration must be preceded by adequate treatment. Primary treatment would be acceptable in theory from a regulatory standpoint since septic tanks are traditionally used to provide pretreatment prior to subsurface disposal. Such a low level of treatment, however, would not be recommended due to the need for a very low loading (application) rate to ensure adequate physical/biological removal of contaminants within the soil interstices and to avoid hydraulic overloading resulting from clogging of the infiltrative surfaces. Treatment processes to remove nutrients would also be

⁸During a community informational meeting, a Waimanalo resident suggested examining the construction of large trenches as a potentially cost-effective means of effluent disposal.

highly recommended to avoid discharge of excessive nutrients in nearshore waters. This would be of concern since the large volume of wastewater deposited into the shallow sand stratum may "surface" in nearshore coastal waters.

Infiltration systems may be classified as either slow or high rate systems. Slow-rate infiltration involves the application of wastewater to vegetated land to provide treatment and to meet the growth needs of the vegetation. Slow-rate systems would be similar to and essentially encompass the reclaimed water alternatives previously discussed. In high rate systems (also known as rapid-infiltration systems), treated wastewater is applied to either subsurface trenches or beds filled with gravel or to open shallow spreading basins. Subsurface systems have the advantage of being capable of being designed to reduce the impacts of wet weather surface runoff, to be concealed below ground for aesthetics, and to allow other use of the land. Open spreading basins have the advantage of being capable of being dried out and tilled to rejuvenate the infiltrative surfaces and allow for a high loading rate.

Both subsurface and surface spreading high rate systems can be designed to provide a high degree of wastewater treatment with the exception of nutrient (nitrate) removal. For this reason, high rate infiltration systems were evaluated on the basis of providing nutrient removal and secondary treatment by conventional means. The system would serve primarily as an effluent disposal method.

Soil permeability is a key site consideration. In Waimanalo, the construction of a high rate infiltration system would be most appropriate in the Jaucas Sand soil located in the low lying coastal areas. Allowable application rates are generally limited in infiltration type systems to allow for decreases in infiltrative capacity of the soil due to clogging.

Based on a relatively high application rate of 8 gpd/ft² rate, the area required to handle 1 mgd of effluent flow would be approximately three acres. The estimated cost of land alone for approximately 1 mgd of effluent disposal capacity using an infiltration basin would be on the order of \$1.3 million. This estimate is based on a relatively low raw land cost of \$10 per square foot. It may be concluded that this alternative would not be cost-effective if the land must be purchased for the infiltration facilities.

An alternative involving the construction of a subsurface deep bed infiltration system at the Waimanalo WWTP site was examined to evaluate the scenario

where there would be no land costs. It was assumed that the bottom of the system would be at elevation 7 feet mean sea level to: 1) allow for gravity flow to the system, 2) minimize lateral migration of the effluent to nearby drainage ditches, and 3) provide an unsaturated soil zone for additional "polishing" of the effluent. A 0.7 acre system built on available land at the Waimanalo WWTP site would have a capacity of only 0.23 MGD and would have an estimated cost of \$200,000.

Advantages of the system include:

- Provides additional treatment due to percolation of effluent through an unsaturated zone.
- Has ability to store excess flows in the voids of the fill material.

Disadvantages include:

- Some nitrogen remaining in the effluent will be discharged to nearshore waters via the groundwater since not all the nitrogen will be removed in the treatment process. Approximately *15 lb/day* will be discharged based on an approximate total nitrogen concentration of *8 mg/L* and 0.23 mgd flow (equivalent to approximately 300 cesspool users at a 0.031 lb/day/capita nitrogen generation rate).
- Saturated soil conditions may impact performance during wet weather (the surface soils are relatively permeable and the treatment plant is in a flood zone).
- If designed as a subsurface system, the system cannot be readily backwashed or cleaned to restore its infiltrative capacity.
- Actual soil conditions are unknown (there may be pockets of alluvial clay material at the site which may adversely impact infiltrative capacity).

Based on the above information, rapid infiltration systems are not considered cost-effective for Waimanalo and therefore were not given further consideration.

■ Alternative 4 - Ocean outfall

The construction of a submarine ocean outfall for effluent disposal was considered, but not considered to be feasible due to the high capital cost and

extensive permitting requirements associated with its construction and operation. The 1984 facilities plan estimated that a 24-inch diameter outfall extending 8,700 feet into the ocean and discharging in waters 60 feet deep would cost approximately \$14 million (1984 dollars). The use of an outfall would be contrary to the current trend toward beneficial reuse of effluent for irrigation. This alternative was not given further consideration.

■ Alternative 5 - Pumping to the Kailua Regional WWTP

The alternative of pumping either pretreated raw wastewater or treated effluent to the Kailua Regional WWTP was briefly evaluated.

The pretreatment alternative would involve first subjecting the wastewater to screening and grit removal at the Waimanalo WWTP site. The wastewater would then be pumped to the Kailua Regional WWTP for secondary treatment and disposal through the Mokapu marine outfall. The existing process tanks such as the primary clarifiers and Rapid Bloc aeration/settling tanks could be retained to provide flow equalization and wet weather storage if desired. The injection wells could also be used on an emergency basis to avert spills. This alternative represents a treatment alternative in addition to a disposal alternative since most of the wastewater treatment would take place at the Kailua Regional WWTP.

The alternative for only effluent disposal would involve pumping secondary treated effluent to the Kailua Regional WWTP for discharge into the Mokapu outfall. Under this alternative, the need for filtration of the effluent would be eliminated since a lower quality of effluent would be acceptable for outfall disposal.

In either alternative involving the Kailua Regional WWTP, a transmission line (force mains and sewers) of approximately 8 miles in length would be required. The wastewater pumping requirements would be severe. If the force main were to be constructed along Kalaniana'ole Highway (then down Kailua Road, Kuulei Road and Kalaheo Avenue), the estimated elevation at the high point would be on the order of 228 feet (approximately 0.5 miles west of the Keolu Drive intersection). An alternative route would be to traverse Bellows AFS and possibly tunnel under Kaiwa Ridge near Lanikai.

Multiple pump stations would be required for pumping of pretreated wastewater due to high heads from static heads (Kalaniana'ole Highway route) or high force main frictional losses (Bellows AFS route). The large peaking factor for the Waimanalo collection system is especially difficult for

pumping of the pretreated wastewater. A large force main (low head losses) would tend to create long detention times under average flow conditions whereas a smaller force main would result in excessive head losses during peak flow conditions.

The pumping of pretreated wastewater was not considered to be cost-effective and not given further consideration for the following reasons:

- The force main would be costly due to its length and construction within many fully developed areas. Assuming an average cost of \$600 for an 18-inch diameter force main for the full length of the line, the cost of the force main alone would be on the order of \$25 million.
- Two to three pumping stations will be required. Each pump station is estimated to cost on the order of \$3 million each. The use of multiple pumps stations decreases the reliability of the transmission system and increases the likelihood of spills.
- The long travel distances would likely result in septic wastewater and additional odor generation at the Kailua Regional WWTP.
- Transmission of wastewater to the Kailua Regional WWTP would eliminate the option of using treated effluent for irrigation in Waimanalo.
- The Kailua Regional WWTP is already hard pressed in handling its current peak wet weather flows. Contribution of wet weather flows from Waimanalo would aggravate the problem and increase the need for expanded facilities.
- The Kailua Regional WWTP was recently expanded and future proposed expansions of the plant are not intended to accommodate the Waimanalo flows. Providing the additional required capacity may be difficult or uneconomical since the additional flows have not been "masterplanned" into the proposed future expansion.
- Many residents of Kailua, particularly those residing in the vicinity of the Kailua Regional WWTP, are strongly opposed to the further expansion of the plant and treatment of wastewater generated from areas outside of Kailua.

The alternative of pumping treated effluent to the Kailua Regional WWTP would share only some of the disadvantages of the pretreated wastewater

option. The effluent transmission option would not have the disadvantages of requiring multiple pump stations,⁹ wastewater septicity, and Kailua Regional WWTP capacity concerns. The cost of expanding and operating the existing Waimanalo WWTP, however, would remain. The cost of the transmission line alone results in this alternative being less cost effective than construction of effluent filters, additional injection wells and/or implementing a reuse option.

The transmission of Waimanalo wastewater to the Kailua Regional WWTP was not considered to be a viable option and is therefore not given further consideration.

Based on the above discussion, the viable effluent disposal alternatives include injection wells (Alternative 1) and effluent irrigation reuse (Alternative 2). The irrigation reuse alternatives are comprised of two primary subalternatives. These are implementing irrigation reuse at the agricultural farm lots (Alternative 2a) and at the Olomana Golf Links (Alternative 2b). The irrigation reuse alternatives require sufficient backup disposal capacity. The continued use of injection wells offers a cost-effective means of providing backup capacity. The alternatives are not mutually exclusive and all the alternatives could conceivably be implemented.

A cost-effectiveness evaluation of the three effluent disposal alternatives based on monetary and non-monetary factors was performed. Non-monetary factors examined included performance/reliability, operation and maintenance requirements, water quality/public health protection, funding, energy consumption, construction impacts/ease of implementation, and overall environmental impacts. A summary of the evaluation results is presented in Table 2-4.

The continued use of injection wells is considered to be a cost-effective method of disposing of effluent at the Waimanalo WWTP whether as the primary means of disposal or as backup to irrigation reuse disposal. Water quality impacts from the standpoint of nutrient loading is a potential concern. The impacts, however, should be less than that of cesspools and other sources of groundwater and surface water contaminants if the treatment plant is provided with nitrogen removal capability (see discussions in Chapter 5).

The reuse of effluent for agricultural and landscape irrigation should be pursued to reduce dependence on the injection wells, to meet water demands in the area, and to conserve potable water resources. As indicated in Chapter 1, effluent reuse is not

⁹High head water pumps may be used for effluent in lieu of low head non-clog pumps for wastewater.

**TABLE 2-4
COMPARISON SUMMARY OF EFFLUENT DISPOSAL ALTERNATIVES**

Effluent Disposal Alternative	Costs	Performance and Reliability	Operation and Maintenance	Water Quality and Public Health	Availability of Funding	Energy Consumption	Construction/Implementation	Environmental and Social Impacts
<u>Alternative 1</u> Injection Wells (1.1 mgd avg. flow)	Capital Cost: \$1,210,000 Annual Maintenance Cost: \$45,000 Total Present Worth: \$1,730,000 Annualized Cost: \$150,000 Annualized Cost per Kgal Avg. Flow: \$0.38 (capital costs include three new wells, piping and instrumentation)	Moderate to Good - Due to clogging problems, capacity can decrease substantially from poor effluent quality. Able to accept poor quality effluent if necessary for short durations without major adverse impacts. Reliability of flow handling capacity can be acceptable with high quality effluent, well capacity monitoring and periodic cleaning.	Moderate - Requires periodic cleaning by backwashing, pumping, sediment bailing, air jetting, and other means. In the future, effort required to operate and maintain filters although the filter should reduce well clogging substantially. Existing backwashing equipment requires maintenance. Administrative and effluent monitoring effort required for UIC permit.	Moderate - High quality effluent resulting from improved suspended solids removal and disinfection, and reduction of nitrates should minimize water quality impacts. Subsurface geology minimizes nearshore surfacing of effluent. The probability of spills should be minimal following proposed facility improvements.	Moderate - DLNR will need to seek funding. Funding mechanism would be similar to other plant upgrade work.	Low - Flow to injection wells is by gravity flow. Some energy required for filtration equipment.	Good - No major siting problems anticipated. Work is within treatment plant site boundaries.	Generally Positive - Removal of nitrates minimizes water quality impacts. Low energy consumption. Limited nuisance impacts (noise, odors, dust) since construction is primarily limited to plant site. No adverse impacts to archeological, historical and cultural resources anticipated.
<u>Alternative 2a</u> Irrigation of Farm Lots 0.18 mgd avg. flow)	Capital Cost: \$3,610,000 Annual Maintenance Cost: \$46,000 Total Present Worth: \$3,760,000 Annualized Cost: \$328,000 Annualized Cost per Kgal Avg. Flow: \$4.49 (capital costs include chemical feed equip., UV disinfection unit, pump station, force main, storage reservoir, irrigation pumps, distribution lines)	Low to Moderate - Requires backflow/supplemental effluent disposal, particularly during wet weather. Also requires high quality effluent. If effluent does not meet stringent quality requirements, other disposal means must be used.	High - Requires considerable effort for maintenance of filters, disinfection and monitoring equipment, and effluent pumping station. Additional effort required for effluent quality analyses, recordkeeping, and administrative tasks.	High - Reduces discharge of effluent to coastal waters. Nutrients are recycled due to uptake by vegetation. Public health risks anticipated to be minimal due to high effluent quality and extensive monitoring requirements.	Good - Funding from U.S. Dept. of Agriculture and Natural Resources Conservation Service available. Other funding sources include State Dept. of Agriculture, University of Hawaii, and City and County of Honolulu.	High - Energy required for filters, UV disinfection and effluent pumping.	Moderate - No major siting problems anticipated. Requires construction of transmission mains, reservoir and other facilities outside plant boundaries. Time and effort required to secure DOH reuse permits /approvals.	Generally Positive - Transforms potential environmental liability to valuable resource. Conserves potable water resources. Recycles nitrogen through vegetation. Fairly high energy consumption. Potential nuisance impacts (noise, odors, dust) since offsite construction involved. No adverse impacts to archeological, historical and cultural resources anticipated.

**TABLE 2-4
COMPARISON SUMMARY OF EFFLUENT DISPOSAL ALTERNATIVES (continued)**

Effluent Disposal Alternative	Costs	Performance and Reliability	Operation and Maintenance	Water Quality and Public Health	Availability of Funding	Energy Consumption	Construction/Implementation	Environmental and Social Impacts
Alternative 2b Irrigation of Olomana Golf Links (0.13 mgd avg. flow)	Capital Cost: \$3,250,000 Annual Maintenance Cost: \$29,000 Total Present Worth: \$3,580,000 Annualized Cost: \$312,000 Annualized Cost per Kgal Avg. Flow: \$6.58 (capital costs include chemical feed equip., UV disinfection unit, pump station, force main, storage reservoir, irrigation pumps)	Low to Moderate - Requires backup/supplemental effluent disposal, particularly during wet weather. Also requires high quality effluent. If effluent does not meet stringent quality requirements, other disposal means must be used.	High - Requires considerable effort for maintenance of filters, disinfection and monitoring equipment, and effluent pumping station. Additional effort required for effluent quality analyses, recordkeeping, and administrative tasks.	High - Reduces discharge of effluent to coastal waters. Nutrients are recycled due to uptake by vegetation. Public health risks anticipated to be minimal due to high effluent quality and extensive monitoring requirements.	Good - Funding potentially available from Olomana Golf Links, City and County of Honolulu and Board of Water Supply.	High - Energy required for filters, UV disinfection and effluent pumping. Reduces energy for potable water pumping however.	Moderate - No major siting problems anticipated. Anticipated to require construction of mains along Kalaniana'ole Highway. Time and effort required to secure DOH permits/ approvals	Generally Positive - Transforms potential environmental liability to valuable resource. Conserves potable water resources. Recycles nitrogen through vegetation. Fairly high energy consumption. Some construction impacts. Potential nuisance impacts (noise, odors, dust) since onsite construction involved. Some potential impacts to archeological, historical and cultural resources due to pipeline excavation near Bellows AFS.

Note: Present worth is based on 20 year life, 6 percent discount rate and no salvage value. Annual unit costs shown are based on 1.1 mgd average flow.

anticipated to be economically feasible based solely on costs but can be justified based on water quality benefits and other non-monetary factors. Additional water quality studies will help determine the extent to which reclaimed water projects should be pursued (see discussions in Chapter 5).

Evaluation of Sludge Disposal Alternatives

Sludge consists of the solid and semi-solid materials removed from the liquid waste stream at a wastewater treatment plant. Sludge refers primarily to the organic residual matter from primary and secondary treatment processes but may also include grit, scum and screenings. Sludge may also be referred to as "biosolids" or simply "solids." Biosolids is a term recently coined by the wastewater industry to present a more positive image to the public, particularly with respect to beneficial reuse of the material as a soil amendment. The terms are used interchangeably in this document.

Liquid sludge from the Waimanalo WWTP is currently hauled to Kailua Regional WWTP for treatment and disposal. It may be cost-effective to use the existing unused sludge drying beds at the Waimanalo WWTP in the future as the volume of sludge at the Waimanalo WWTP increases and the surplus solids handling capacity at the Kailua Regional WWTP decreases. Unless programs for beneficial reuse of sludge are implemented in the future, dewatered sludge from the Waimanalo WWTP would be disposed of at the Waimanalo Gulch sanitary landfill in Nanakuli. Stabilized and dewatered Kailua Regional WWTP sludge, which currently includes solids from the Waimanalo plant, is disposed of at the Waimanalo Gulch landfill.

The Waimanalo Facilities Plan examined the feasibility of implementing a beneficial sludge reuse program in lieu of continued landfilling. Sludge disposal and reuse are regulated by the provisions of 40 CFR 503, entitled "Standards for the Disposal of Sewage Sludge." The requirements are based on risk assessment of the hazards of various sludge reuse practices. The low concentration of heavy metal pollutants in Waimanalo WWTP sludge should permit compliance with the requirements of the 503 rule. The sludge, however, must also meet specified pathogen and vector attraction reduction limits for various land application uses, and for sale and use with minimal restrictions. Depending on how the Waimanalo sludge is processed, different uses would be permitted based on the pathogen and vector attraction reduction requirements.

Two pathogen reduction classes are defined by the regulations, Class A and Class B. The two classes differ depending on the level of pathogen reduction that can be achieved by various processes. The processes specified for Class A sludge achieve a greater pathogen reduction level than those for Class B. Unlike Class A sludge, in which pathogens are at below detectable levels, Class B sludge may contain some

pathogens. For this reason, some restrictions are placed on the land application of Class B sludge that prevent crop harvesting, animal grazing, and public access for a certain period of time after application. The Part 503 rules on pathogen reduction is important with respect to the future of sludge reuse on Oahu and the evaluation of sludge handling and disposal alternatives.

The N-Viro alkaline stabilization process was proposed for a centralized sludge processing facility by the City but has been not been implemented due to lack of an acceptable site. This process is designated as a "Process to Further Reduce Pathogens" (PFRP) by the EPA, and therefore results in Class A sludge. The N-Viro process utilizes the combination of high pH and high temperature to achieve pathogen kill.

Composting by the windrow method is considered a PFRP if the temperature of the pile is maintained at 55°C or higher for 15 days or longer. During the period when the compost is maintained at 55°C or higher, the windrow must be turned a minimum of five times.

Either of the above PFRP processes would result in a Class A product that would be considered safe for a variety of uses under the provisions of the Part 503 rules. Restrictions to the use of Class A sludge are minimal. Possible uses include landfill cover, fertilizer for golf courses and turf farms, fertilizer for various food and nonfood crops, and a substitute for soil in landscaping.

Anaerobic digestion has been designated as a "Process to Significantly Reduce Pathogens" (PSRP) as long as certain parameters are met. The values for the mean cell residence time and temperature must be between 15 days at 35°C to 55°C and 60 days at 20°C. Sludge digestion at Waimanalo WWTP will be capable of meeting these requirements and sludge discharged to the drying beds would be classified as a Class B sludge.

Class B sludge land application use is restricted as summarized below:

- Food crops with harvested parts that touch the sludge solids and are totally above the land surface shall not be harvested for 14 months after application of the solids.
- Food crops with harvested parts below the surface of the land shall not be harvested for 20 months after application of sludge when the sludge remains on the land surface for 4 months or longer after incorporation into the soil.

- Food crops with harvested parts below the surface of the land shall not be harvested for 38 months after application of sludge when the sludge remains on the land surface for less than 4 months prior to incorporation into the soil.
- Food crops with harvested parts that do not touch the sludge, feed crops, and fiber crops shall not be harvested for 30 days after application of sludge.
- Animals shall not be grazed on the land for 30 days after application of sludge.
- Turf grown on land where sludge is applied shall not be harvested for one year after application of the sludge when the harvested turf is placed on either land with a high potential for public exposure on a lawn, unless otherwise specified by the permitting authority.
- Public access to land with a high potential for public exposure shall be restricted for one year after application of sludge.
- Public access to land with a low potential for public exposure shall be restricted for 30 days after application of sludge.

Pathogens in sludge pose a disease risk when they are brought into contact with humans or other susceptible hosts (plant or animal). Vectors, which include flies, mosquitoes, fleas, rodents, and birds, can transmit pathogens to humans and other hosts physically through contact or biologically by playing a specific role in the life cycle of the pathogen. Reducing the attractiveness of sludge to vectors reduces the potential for transmitting diseases from pathogens in sludge.

Ten options specified in Part 503 qualify as vector attraction reduction processes. One of the processes must be employed for the sludge to qualify as "high quality sludge." One of the options involves achieving a 38 percent reduction in volatile solids content through the treatment process. This percentage is based on volatile solids reductions that typically can be achieved by anaerobic digestion and other subsequent processing, such as dewatering in the drying beds. The dewatered digested sludge from Waimanalo WWTP should be able to consistently meet the vector attraction reduction requirements in the Part 503 rule.

The Sludge Management Plan (1995) proposed a City managed beneficial reuse program as a backup to privatized reuse alternative such as the N-Viro project. The City managed beneficial reuse program included a proposal for a regional windrow composting facility at the Waimanalo WWTP to process sludge from both the Kailua and Waimanalo WWTPs.

Composting of sludge involves aerobic decomposition of the organic constituents by thermophilic organisms to a relatively safe, useful and aesthetically acceptable product. Windrow composting employs an amendment such as wood chips as a bulking agent and frequent mixing by mechanical means to aerate the compost pile. The composting material is arranged in long parallel rows (windrows) that are typically 15 feet wide at the base and three to seven feet high (Barrett, 1995). Sludge stabilization can typically be achieved in five weeks.

The proposed composting facilities in the Sludge Management Plan encompassed a 2.4 acre site at the Waimanalo WWTP along the Hihimanu Street side of the site. The study's capital cost estimate for the composting facility was \$3.0 million, in terms of 1994 dollars, including 20 percent contingency and a 5 percent inflation allowance. The estimated cost excluded land acquisition costs, enclosure structure, and odor control facilities. The annual operation and maintenance costs for 1995 sludge volumes (maximum month of 2.9 tons per day) were estimated at approximately \$280,000, without considering any cost recovery from the sale of the compost product.

Despite the proposed expansion of the treatment facilities at the Waimanalo WWTP, sufficient space for the regional composting facility would still be available. The proposed facilities could be reconfigured to utilize other unused areas of the plant site. Other site factors, however, would favor another location for the facility. These factors include:

- The Waimanalo WWTP is located in a flood zone. To prevent composting material from becoming inundated and running off the site, the site would need to be raised by two to three feet (elevation 14 feet above MSL). An alternative would be to construct a flood control levee or wall around the site. A recent flood study indicates that the 100-year flood elevations may potentially be increased to approximately 18 feet above MSL at the Waimanalo WWTP site.
- During rainy weather, the site would generate a considerable amount of contaminated runoff that would need to be contained and treated. The Waimanalo WWTP is already plagued with high wet weather flows due to excessive infiltration and inflow in the collection system. One option, which would be very costly, would be to construct an enclosure around the composting facility. Enclosing the active composting area of approximately 1.5 acres at a cost of \$40 per square foot would amount to a cost of \$2.6 million. Another option would be to construct a detention pond for the runoff.

- The Waimanalo WWTP is located near existing residences and odors would be a significant concern. To control odors, an enclosed facility with odor control provisions would be required. The Waimanalo residents are particularly sensitive to odor issues due to odor problems generated by the UNISYN waste processing facility in Waimanalo.
- The City's composting ordinance (Ordinance 94-64) establishes a specific land use category for composting. Composting of offsite sewage sludge (i.e., Kailua Regional WWTP sludge) would classify the project as a Type 2 "major" composting site. A Conditional Use Permit and public hearings would be required.
- There would be concerns related to noise, dust and traffic generated by trucks hauling sludge, bulking agents and the finished composted product on Kalaniana'ole Highway.
- The composting facility will probably require more area than originally estimated. The average of 2.6 tons dry solids per day for 1995 (3.1 tons per day for year 2010) previously estimated appears to be low. Operating records indicate that 1,071 dry tons of sludge (2.9 tons per day) were produced in 1996 at the Kailua Regional WWTP. Of this annual amount, 80 tons (7.5 percent) were from the Waimanalo WWTP and 2 tons (0.2 percent) were from the Kahuku WWTP.

A composting facility on other lands in Waimanalo is not anticipated to be cost-effective or environmentally compatible with nearby land uses. At a cost of over \$200,000 per acre for agricultural land in Waimanalo, the land cost would be substantial, particularly if buffer zones around the perimeter of the facility were provided.

A site closer to the Kailua Regional WWTP would be desirable since the majority of the solids are generated there. Consideration might be given to a site at or near the former Kapaa or Kalaheo landfill sites. Environmental impacts such as odors and contaminated runoff, which would be somewhat similar to the former landfill operations, could be managed through implementation of various mitigative measures.

Production of 40 CFR 503 Class B biosolids could potentially be accomplished at the Waimanalo WWTP upon the planned replacement of a malfunctioning sludge digester heater. The primary limitations for implementing this alternative include:

- Probable higher operating costs for onsite dewatering using the existing sludge drying beds (versus hauling to the Kailua Regional WWTP).

- Administrative costs for complying with the 503 regulations.
- Lack of users for the Class B sludge.

The Class B sludge reuse alternative could be implemented at some time in the future when operational and market conditions are favorable. A marketing study should be conducted to assess the relative demand of Class A and Class B quality sludges. This study would be especially justified if a privatized island-wide sludge reuse alternative is not found to be viable.

The following is recommended with respect to sludge reuse alternatives:

- The Waimanalo WWTP sludge should continue to be hauled to the Kailua Regional WWTP until such time as the City determines that this procedure is no longer cost-effective. *Sludge dewatering at the Waimanalo WWTP is projected to be cost-effective after upgrades to the existing sludge drying beds are implemented.*
- The City should pursue efforts to implement a privatized beneficial sludge reuse program or evaluate an alternative City managed reuse program for 40 CFR 503 Class A sludge.
- Consideration should be given to a 40 CFR 503 Class B sludge reuse program in the event that a market for the product can be developed and Class A sludge alternatives are not implemented.

1
2
3
4
5
6
7
8
9
10
11
12
13
14
15
16
17
18
19
20
21
22
23
24
25
26
27
28
29
30
31
32
33
34
35
36
37
38
39
40
41
42
43
44
45
46
47
48
49
50
51
52
53
54
55
56
57
58
59
60
61
62
63
64
65
66
67
68
69
70
71
72
73
74
75
76
77
78
79
80
81
82
83
84
85
86
87
88
89
90
91
92
93
94
95
96
97
98
99
100

Chapter 3

Environmental Setting

CHAPTER 3

ENVIRONMENTAL SETTING

INTRODUCTION

This chapter describes the physical and biological aspects of Waimanalo's natural environment along with the characteristics of the urbanized community. The environmental setting influences the community's wastewater management needs and the required actions to best meet those needs.

The Waimanalo planning area is bounded by Keolu Hills to the northwest, Waimanalo Bay to the northeast, Makapuu Point to the east, and the Koolau Mountain Range ridgeline to the south. The Waimanalo planning area encompasses approximately 7,100 acres.

This chapter is organized as follows:

Characteristics of the Physical Environment

- | | |
|----------------------|--------------------|
| 1) Climate | 5) Streams |
| 2) Topography | 6) Wetlands |
| 3) Geology and soils | 7) Coastal waters |
| 4) Groundwater | 8) Natural hazards |

Characteristics of the Biological Environment

- 1) Terrestrial and Freshwater Biota
- 2) Marine biota

Characteristics of the Developed Community Environment

- | | |
|--------------------------------|------------------------------------|
| 1) Historical overview | 3) Land ownership |
| 2) Economic and social profile | 4) Population and projected growth |

Characteristics of the Developed Community Environment (continued)

- | | |
|----------------------------------|--|
| 5) Water supply | 10) Electrical utilities |
| 6) Wastewater facilities | 11) Recreational facilities |
| 7) Drainage facilities and flood | 12) Historical/archeological resources |
| 8) Solid waste disposal | 13) Air quality |
| 9) Transportation facilities | 15) Noise levels |

CHARACTERISTICS OF THE PHYSICAL ENVIRONMENTClimate

The Waimanalo planning area has a climate that is generally typical of Windward Oahu. The temperatures in the area are typically mild and uniform, with the monthly average ranging from 70 degrees F in January to 78 degrees F in August. The average annual temperature is 74 degrees F.

Average annual rainfall in the Waimanalo area varies considerably with elevation (see Figure 3-1). At the shoreline, average annual rainfall is approximately 40 inches while the average annual rainfall is approximately 100 inches in the Koolau Mountain Range. There is also a seasonal variation in rainfall, with higher rainfall occurring from November through April.

Prevailing winds are northeasterly trade winds which occur approximately 70 percent of the time. Trade wind frequency ranges from about 45 percent in January to more than 90 percent in July. Winds may blow from any direction. High winds are most likely to occur during the winter months. A wind rose is shown on Figure 3-2.

Relative humidity in the planning area ranges between 70 and 80 percent, and is somewhat higher during the winter months than the summer months. Overall, the climate is considered to be comfortable due to the cooling effect of the trade winds.

Topography

The general topography of the Waimanalo area is shown on Figure 3-3. The topography varies considerably as the terrain rises inland from the shoreline to the Koolau Mountain Range. The valley floor occupies about half of the planning area, and consists of a flat coastal plain that transitions into gentle rising lands with less

DATE: 10/16/96 OPER: SH/A
FILE: 9524-22A REVISED: 4/10/98

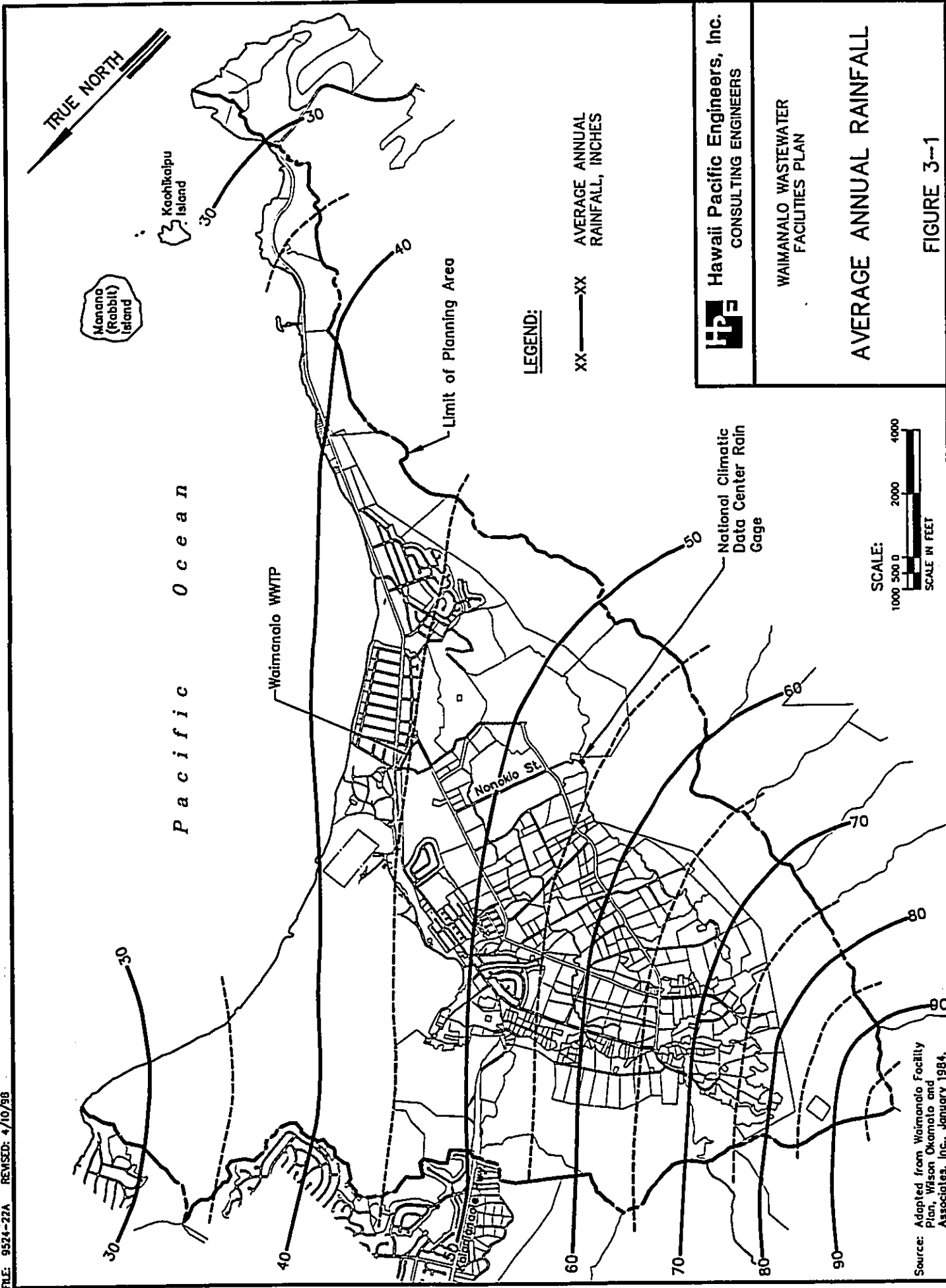

Source: Adapted from Waimanalo Facility Plan, Wilson Okamoto and Associates, Inc., January 1984.

l i p e Hawaii Pacific Engineers, Inc.
CONSULTING ENGINEERS

WAIMANALO WASTEWATER
FACILITIES PLAN

AVERAGE ANNUAL RAINFALL

FIGURE 3-1

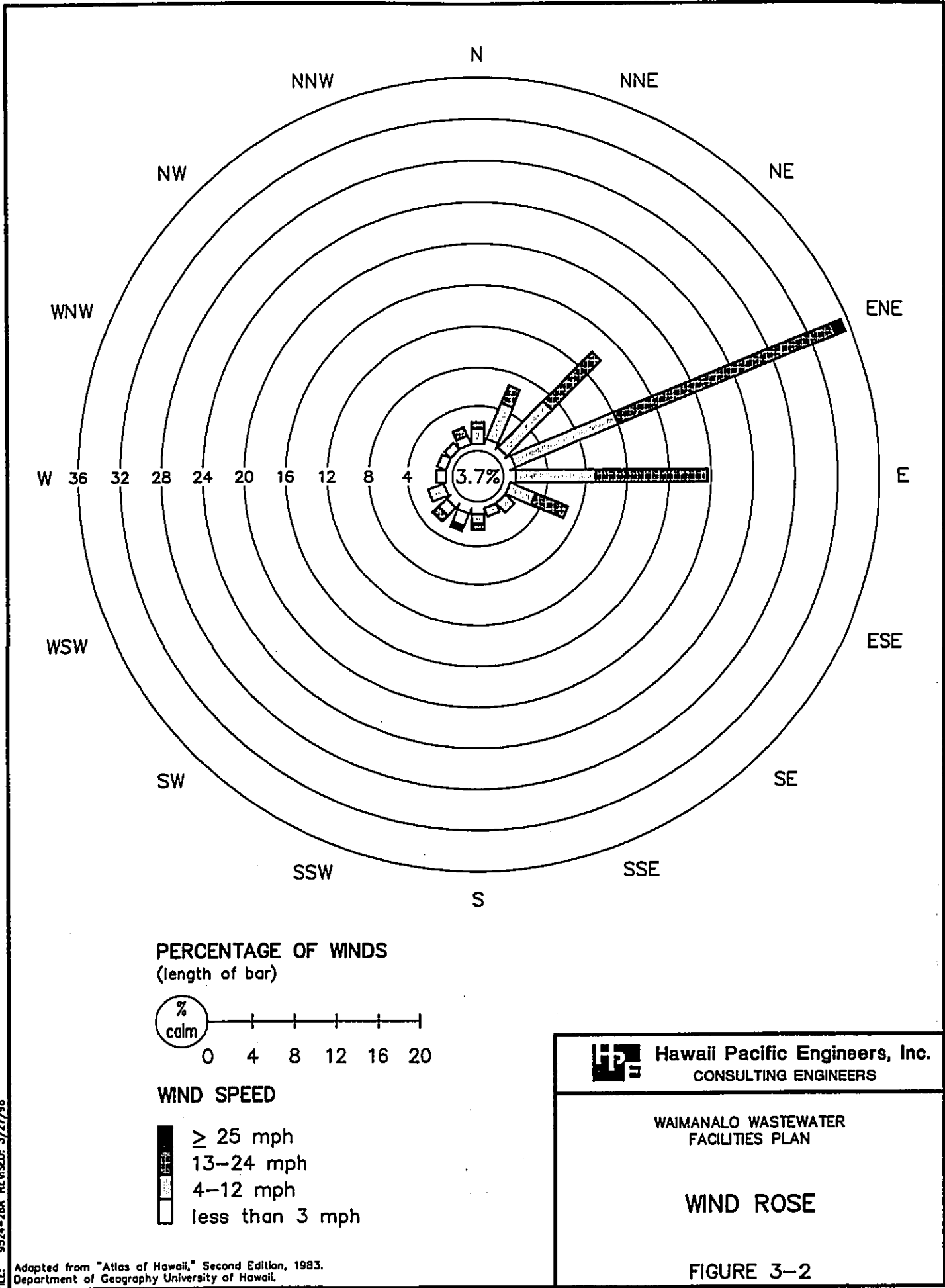

DATE: 10/18/96 RKA
 SCALE: 1" = 1' CMFR: SH/A
 FILE: 9524-2BA REVISED: 3/27/98

Adapted from "Atlas of Hawaii," Second Edition, 1983.
 Department of Geography University of Hawaii.

DATE: 4/10/88
SCALE: 1" = 2000'
FILE: 9524-95

RKA
PAI: OPER: SHA
REVISED: -





Hawaii Pacific Engineers, Inc.
CONSULTING ENGINEERS

WAIMANALO WASTEWATER
FACILITIES PLAN

TOPOGRAPHIC MAP

FIGURE 3-3



GRAPHIC SCALE:



SCALE: 1" = 2000'

Source: Adapted from USGS
Quadrangle Map
(Koko Head, 1983)

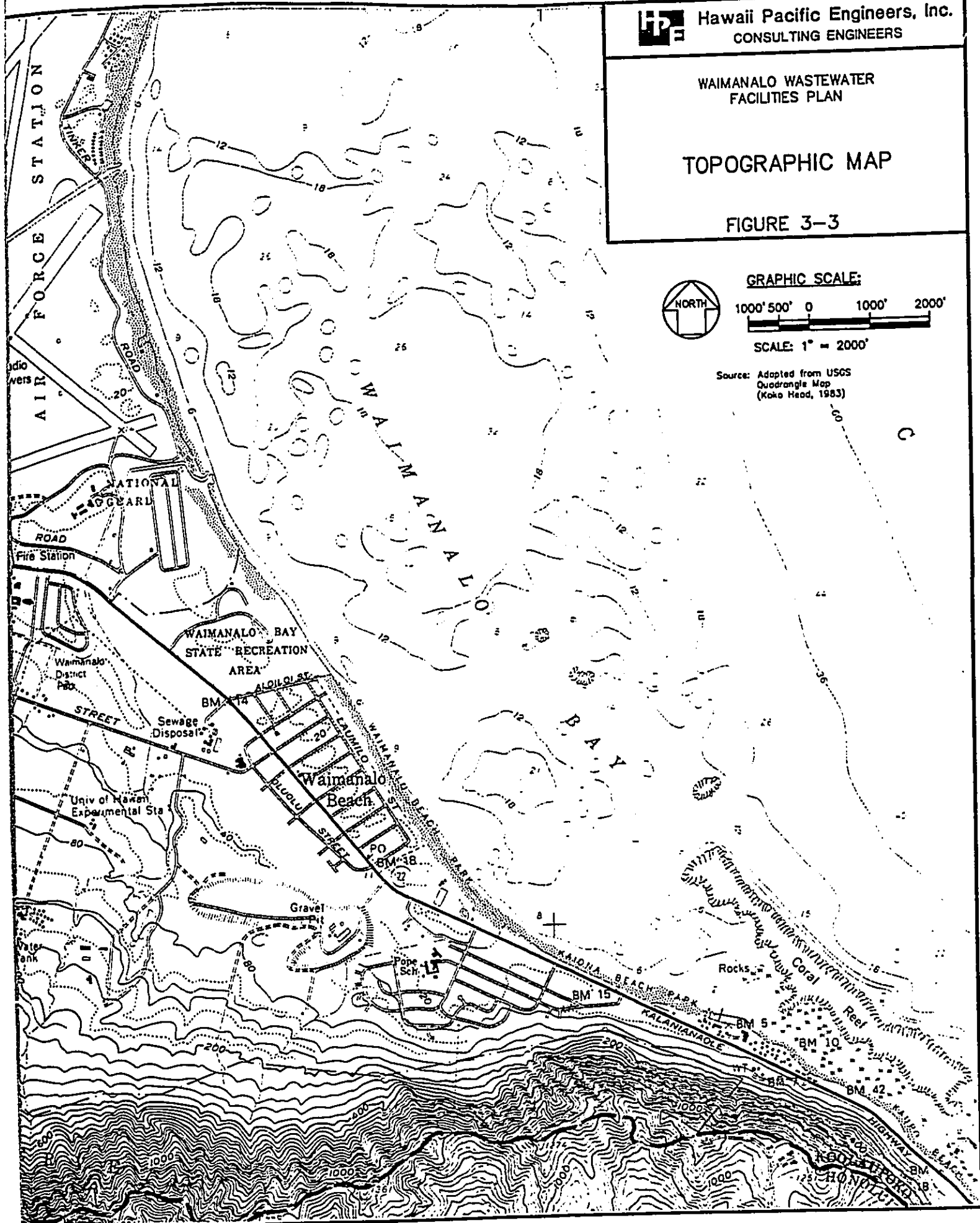

than 12 percent slope in the inland regions. At the foothills of the Koolaus, the slope ranges from 12 to 20 percent. In the remaining mountain region to the crest of the Koolau range, slopes range from 20 percent to nearly vertical.

Geology and Soils

1. Geology

a. General

The general geology of Waimanalo is characterized by three major geological units. These units are basaltic bedrock, alluvium, and coralline deposits. Basaltic bedrock defines the western, southern, and eastern boundaries of the Waimanalo planning area, and generally consists of basaltic flows and dikes of the Koolau dike complex (Harding Lawson Associates, 1992). Alluvium generally lies at the foot of the basalt and primarily consists of highly weathered basaltic sand, gravel, cobbles, and boulders in a matrix of non-calcareous clays and silts. Marine calcareous deposits are expected to occur seaward of the alluvium and generally consist of recent beach and dune sand and other coralline deposits, including older lithified dunes. The alluvium is typically interlayered with coralline deposits in the Waimanalo area. Along the Waimanalo coastline in the extreme eastern part of the study area, the lithified coralline deposits are overlain by lavas and pyroclastic material erupted from a Koko fissure during the post-erosional Honolulu Volcanic Series.

A geological map indicating the approximate boundaries between the geologic units in Waimanalo is shown on Figure 3-4. The map also shows the locations of the State of Hawaii Department of Health (DOH) "UIC line," the Honolulu Board of Water Supply (BWS) "no-pass" line, and BWS potable water wells and water tunnels (see discussions later in this chapter). A generalized geological cross-section is shown on Figure 3-5.

b. Inland Geology

Basaltic bedrock of the original Koolau volcano is exposed in the mountainous west and south portion of the planning area. This rock composes most of the east and north parts of Oahu. Overlying the basalt in Waimanalo are coastal plain sediments of coral interbedded with clays washed down from the mountains.

The subsurface coastal plain sediments in the inland portion consist predominantly of alluvial clays and silts with some gravel interbeds. This

DATE: 10/18/96 PM: RKA
 SCALE: 1=4000 OPR: SWA
 FILE: 9524-24A REVISED: 4/10/98

Pacific
Ocean

LEGEND
 - - - - "UIC" LINE
 - - - - BOARD OF WATER SUPPLY (BWS)
 "NO PASS" LINE
 - - - - ESTIMATED 30 FOOT ELEVATION

Note: See Figure 3-5 for geologic
 cross section "AA"

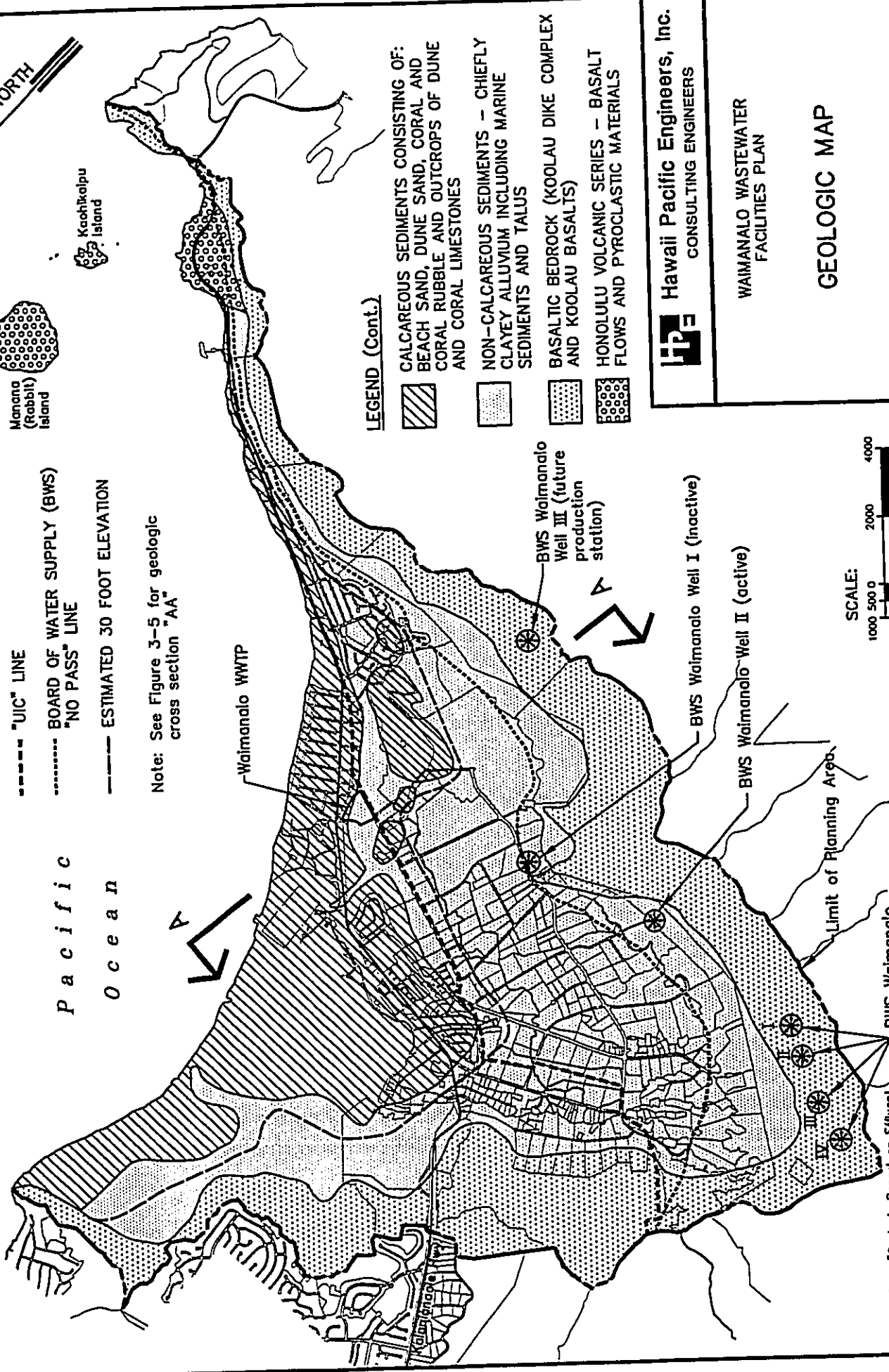
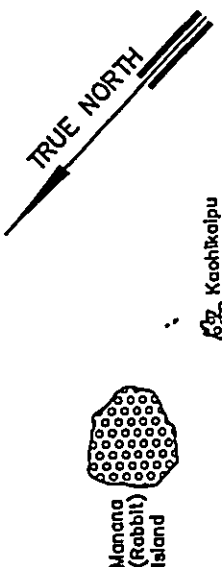

LEGEND (Cont.)

- CALCAREOUS SEDIMENTS CONSISTING OF: BEACH SAND, DUNE SAND, CORAL AND CORAL RUBBLE AND OUTCROPS OF DUNE AND CORAL LIMESTONES
- NON-CALCAREOUS SEDIMENTS - CHIEFLY CLAYEY ALLUVIUM INCLUDING MARINE SEDIMENTS AND TALUS
- BASALTIC BEDROCK (KOOLAU DIKE COMPLEX AND KOOLAU BASALTS)
- HONOLULU VOLCANIC SERIES - BASALT FLOWS AND PYROCLASTIC MATERIALS

HPE Hawaii Pacific Engineers, Inc.
 CONSULTING ENGINEERS

WAIMANALO WASTEWATER FACILITIES PLAN

GEOLOGIC MAP



Adapted from "Geologic Report on Effluent Disposal for Waimanalo, Oahu, Hawaii," Geolabs-Hawaii, 1982. Additional information provided by BWS.

FIGURE 3-4

DATE: 10/18/96
SCALE: 1" = 1500'
FILE: 9524-26A

PM: RKA
OPER: SHJ, CDK
REVISED: 4/23/98

HPE Hawaii Pacific Engineers, Inc.
CONSULTING ENGINEERS

WAIMANALO FACILITIES PLAN

GENERALIZED GEOLOGIC CROSS SECTION 'AA'

FIGURE 3-5

Note: See Figure 3-3 for location of
geologic cross section "AA"

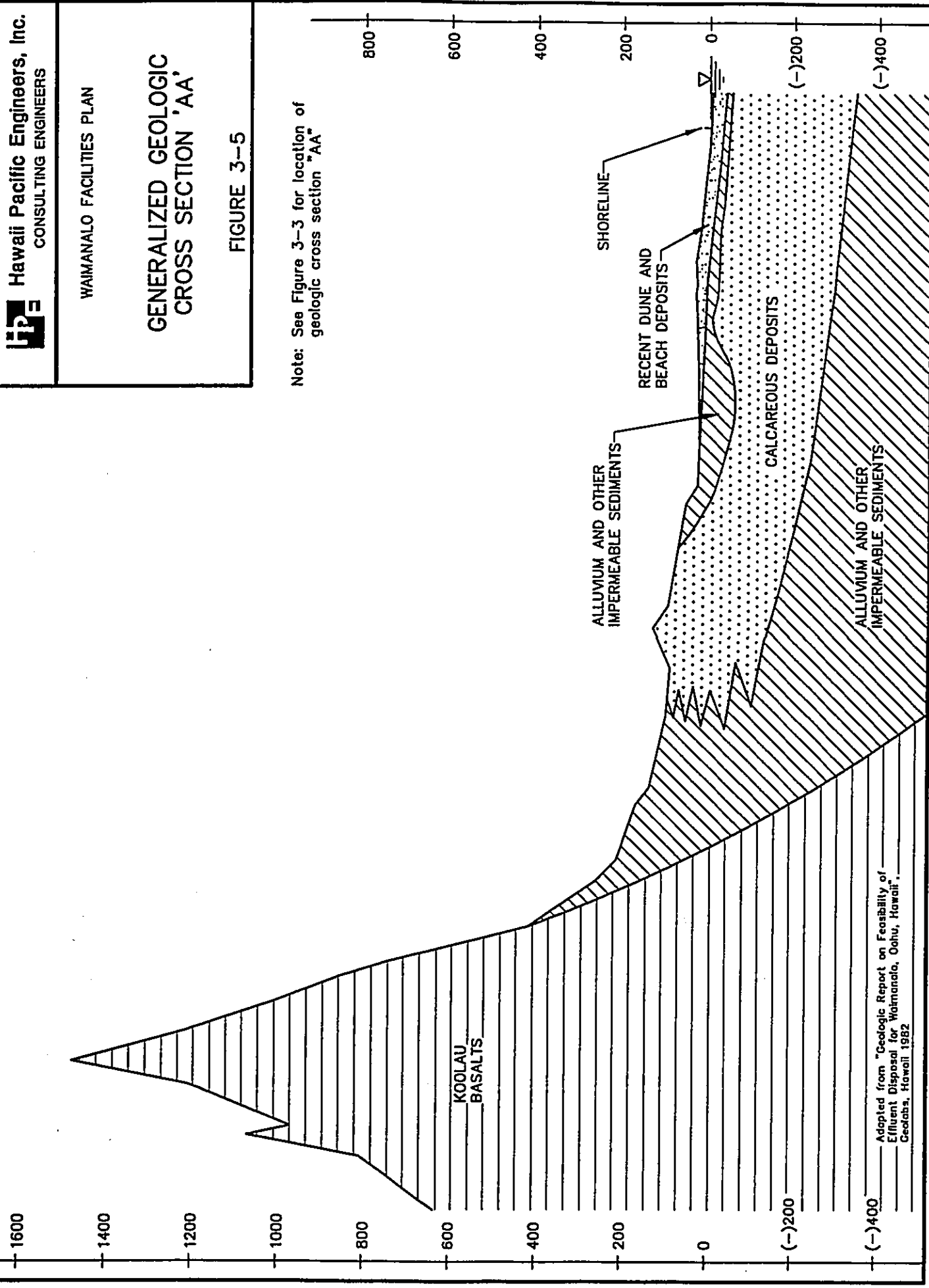

layer is 150 feet or more in thickness and is underlain by basaltic bedrock. These sediments underlie the upland Waimanalo agricultural lots and much of the Hawaiian Home Lands housing projects in the eastern portion of Waimanalo.

c. Seaward Geology

Conditions in the seaward portion of the coastal plain sediments are more complex. At or near the surface, a layer of sands and poorly consolidated limestone extends to depths of approximately 20 to 30 feet below the surface and may be thinly mantled with recent alluvial clays in localized areas. This stratum represents a sequence of recent dune and beach deposits, and is generally very permeable and capable of transmitting large amounts of water. This stratum is found in the vicinity of Bellows Air Force Station (AFS) and the coastal residential areas of Waimanalo. Underlying this sand stratum is a layer of alluvium and other low permeability sediments which extend to depths varying between 35 feet and 110 feet. This stratum was created by alluvial and lagoonal depositions when the sea was below current levels.

Beneath the layer of alluvium and other impermeable materials is the unconfined aquifer stratum comprised of over 200 feet of calcareous sediments consisting of dune limestone, coral, and associated limestones. This is the permeable zone which has been used as the injection aquifer for the existing Waimanalo Wastewater Treatment Plant effluent disposal wells. The low permeability stratum above this permeable zone is believed to minimize "surfacing" of the lower density wastewater effluent in nearshore areas. The extent of the alluvium stratum extending into the ocean, however, is unknown based on available information from geologic studies. Discussions with local researchers (Fletcher and Sherman, 1997) indicate that there are outcrops of the "older" (lower) coral and limestone formations in the nearshore region of Waimanalo Bay. These potentially permeable formations may or may not be resulting in transmission of some diluted treated effluent from the lower geologic formations into the nearshore waters.

Below the unconfined aquifer stratum is another sequence of alluvial and other impermeable sediments deposited during very low levels of the sea, possibly concurrent with the subsidence of the island of Oahu. This sequence is relatively impermeable and serves as a basal confining layer to the caprock aquifer.

The subsidence of Oahu is consistent with tectonic plate theory. Accordingly, as the island moves northwestward away from the volcanic "hot spot" now located at the southern edge of the island of Hawaii, it slowly sinks. Seismic and geomorphic evidence show that the island of Oahu appears to have sunk several thousand feet during its geologic history, but is now stable. In contrast, the historical rate of sinking for the west side of the island of Hawaii appears to be between 1.8 and 3 millimeters per year (Moore, 1987).

Also encountered within the study area during past geologic studies were small amounts of the post-erosional Honolulu Volcanic Series. Most of this unit is tuff and cinder which occur on two offshore islands off Makapuu Beach, and approximately fifty feet of basaltic lava flows overlying calcareous sediments at Sea Life Park. These lava flows are of moderate to low permeability and must be penetrated to reach the underlying highly permeable limestones.

2. Soils

The U.S. Department of Agriculture Soil Conservation Service (SCS, now known as the Natural Resources Conservation Service) soil survey of Oahu (SCS, 1972) states that three soil associations predominate in the Waimanalo planning area: the Kaena-Waialua, Lolekaa-Waikane, and Rock Land-Stony Steep Land Associations. The soil types occurring in Waimanalo are presented on Figure 3-6 and their associated limitations for septic tank drain fields are listed in Table 3-1. Although the SCS soil survey only identifies soil types to a depth of approximately five feet, it does provide an indication of the soil characteristics in the area. Cesspools are typically 10 to 30 feet deep and therefore may discharge into soil types other than those indicated by the SCS information.

The soils of the Kaena-Waialua Association occur on the coastal plains, talus slopes, and in drainageways. The soils developed in alluvium and have a wide range of texture and drainage characteristics. The soils of this association occurring in Waimanalo include Kaena, Waialua, Hanalei, Kawaihapai, Jaucas, Haleiwa, Kaloko, Mokuleia, and coral outcrop.

The soils of the Lolekaa-Waikane Association are found on alluvial fans and terraces upland from the areas where the Kaena-Waialua Association occur. The association consists of well-drained, fine textured, and moderately fine textured soils that are nearly level to very steep. Lolekaa, Waikane, Alaeloa, and Pohakupu soils comprise this association in Waimanalo.

The Rock Land-Stony Steep Land association is located along the steep and precipitous slopes of the Koolau Mountain Range. Soils of this association that have been identified in Waimanalo include Rock Land, Rock Outcrop, and Kawaihapai.

Groundwater

1. Hydrologic Units

Three major hydrologic units occur in the Waimanalo planning area:

- High-level water in dike-intruded lava flows in the upper mountain regions.
- Basal water in dike complexes in the coastal area.
- Basal water in coastal plain sediments.

Dikes are dense, poorly permeable remnant conduits through which lava extruded from the Koolau volcanic shield. Rainfall infiltrating in the mountain regions is retained within these dikes that cross-cut the lava flows. The permeable compartments behind the dikes form natural reservoirs for groundwater. This groundwater is not in contact with seawater and is commonly described as high-level water.

In the coastal regions, the dike complex underlies alluvium and coastal plain deposits. These alluvium and coastal plain deposits form a cap over the dike complex that confine the groundwater under artesian pressure. This groundwater is commonly described as basal water.

Basal groundwater also occurs at shallow depth in the sedimentary deposits underlying the coastal plain in the Waimanalo planning area. The groundwater floats on the heavier seawater due to the density difference between fresh water and saline water. The fresh water characteristically forms a lens-shaped body floating over the saline water. The fresh water lens is dynamic due to variations in water discharge from pumpage, tidal action, and recharge.

2. Aquifer Classifications

The principal aquifers of Oahu have been classified under the State of Hawaii groundwater protection strategy program. This aquifer classification system is consistent with the 1984 U.S. Environmental Protection Agency Groundwater

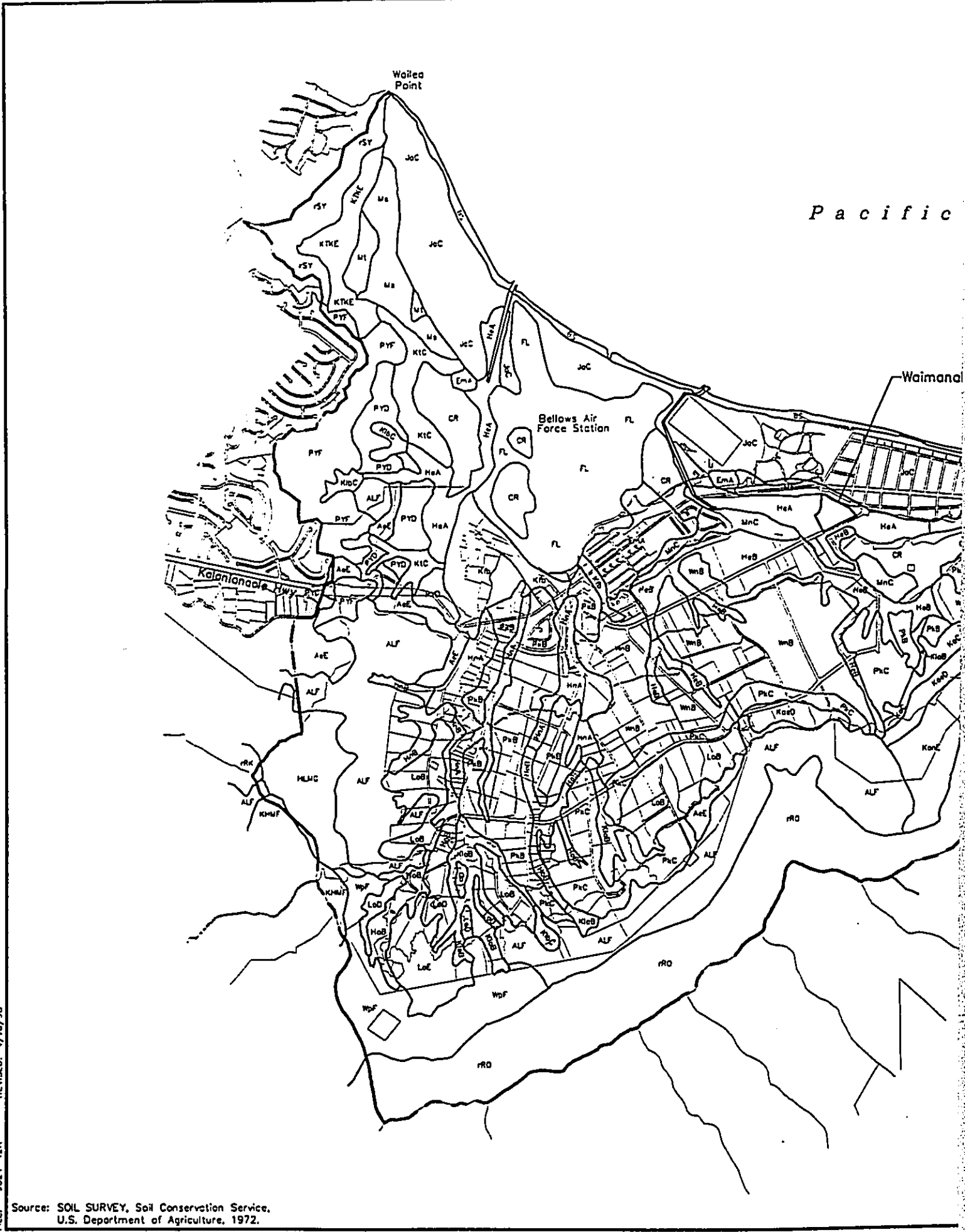

Pacific

Waimanala

Bellows Air Force Station

Kalaniana'olaha Hwy

DATE: 11/18/96
 SCALE: 1" = 3000'
 FILE: 9524-42A

Source: SOIL SURVEY, Soil Conservation Service,
 U.S. Department of Agriculture, 1972.

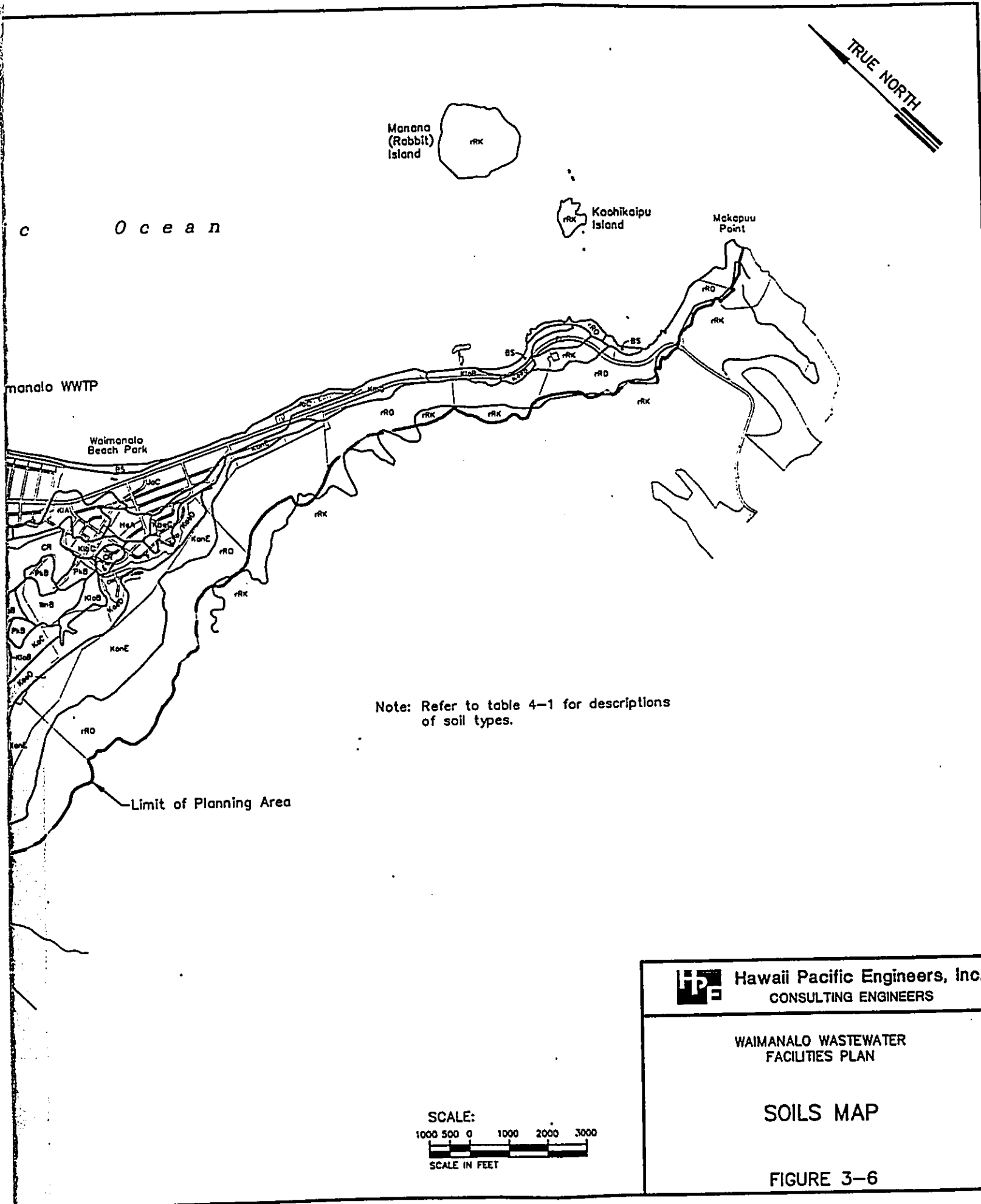

Manana
(Rabbit)
Island



Kauhikaipu
Island



Makena
Point

Ocean

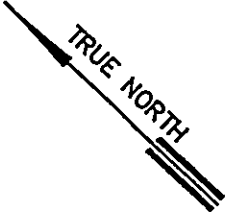

Waimanalo WWTP

Waimanalo
Beach Park

Note: Refer to table 4-1 for descriptions
of soil types.

Limit of Planning Area



Hawaii Pacific Engineers, Inc.
CONSULTING ENGINEERS

WAIMANALO WASTEWATER
FACILITIES PLAN

SOILS MAP

FIGURE 3-6

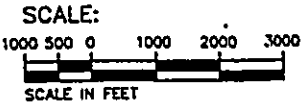

**TABLE 3-1
CHARACTERISTICS OF SOIL TYPES FOUND IN THE
WAIMANALO PLANNING AREA**

Map Symbol	Soil Type	Degree and Type of Limitations for Septic Tank Drain Fields
KAENA-WAIALUA ASSOCIATION		
CR	Coral Outcrop	NA
HeA	Haleiwa silty clay, 0-2% slopes	Slight, except where subject to local flooding
HeB	Haleiwa silty clay, 2-6% slopes	Slight, except where subject to local flooding
HnA	Hanalei silty clay, 0-2% slopes	Severe: high water table, subject to flooding
HnB	Hanalei silty clay, 2-6% slopes	Severe: high water table, subject to flooding
HoB	Hanalei stony silty clay, 2-6% slopes	Severe: high water table, subject to flooding
JaC	Jaucas sand, 0-15% slopes	Slight, rapid permeability
KaC	Kaena clay, 6-12% slopes	Severe: slow permeability
KaeB	Kaena stony clay, 2-6% slopes	Severe: slow permeability
KaeC	Kaena stony clay, 6-12% slopes	Severe: slow permeability
KaeD	Kaena stony clay, 12-20% slopes	Severe: slow permeability
KaeE	Kaena very stony clay, 10-35% slopes	Severe: slow permeability
KfB	Kaloko clay, non-calcareous variant	Severe: slow to moderately slow permeability; high water table; poorly drained; marl layer at shallow depth (less than 20 inches)
KIA	Kawaihapai clay loam, 0-2% slopes	Slight on 0-7% slopes; moderate on 7-15% slopes
KIaB	Kawaihapai stony clay loam, 2-6% slopes	Slight on 0-7% slopes; stoniness
Ms	Mokuleia loam	Slight: loose sand at a depth of 20 inches; rapid permeability below a depth of 20 inches
Mt	Mokuleia clay loam	Slight: loose sand at a depth of 20 inches; rapid permeability below a depth of 20 inches
WnB	Waialua clay, 2-6% slopes	Slight on 0-8% slopes, moderate permeability. Moderate on 8-15% slopes; severe on slopes more than 15%; stoniness in places
LOLEKAA-WAIKANE ASSOCIATION		
AeE	Alaeloa clay, 15-35% slopes	Severe on slopes more than 15%
ALF	Alaeloa silty clay, 40-70% slopes	Severe on slopes more than 15%
LoB	Lolekaa silty clay, 3-8% slopes	Slight on 3-8% slopes; moderate on 8-15% slopes; severe on slopes more than 15%
LoD	Lolekaa silty clay, 15-25% slopes	Slight on 3-8% slopes; moderate on 8-15% slopes; severe on slopes more than 15%

**TABLE 3-1
CHARACTERISTICS OF SOIL TYPES FOUND IN THE
WAIMANALO PLANNING AREA (Continued)**

Map Symbol	Soil Type	Degree and Type of Limitations for Septic Tank Drain Fields
LOLEKAA-WAIKANE ASSOCIATION (continued)		
LoE	Lolekaa silty clay, 25-40% slopes	Slight on 3-8% slopes; moderate on 8-15% slopes; severe on slopes more than 15%
PkB	Pohakupu silty clay loam, 0-8% slopes	Slight on 0-8% slopes; moderate on 8-15% slopes; severe on slopes more than 15%
PkB	Pohakupu silty clay loam, 8-15% slopes	Slight on 0-8% slopes; moderate on 8-15% slopes; severe on slopes more than 15%
WpF	Waikane silty clay, 40-70%	Slight on 3-8% slopes; moderate on 8-15% slopes; severe on slopes more than 15%
ROCK LAND - STONY STEEP LAND ASSOCIATION		
rRk	Rock land	NA
rRO	Rock outcrop	NA
KIbC	Kawaihapai very stony clay loam, 0-15% slopes	Slight on 0-7% slopes; moderate on 7-15% slopes; stoniness
OTHERS		
BS	Beaches	NA
EmA	Ewa silty clay loam, 0-2% slope	Slight: moderate permeability; severe where soil is moderately shallow
FL	Fill land, mixed	NA
HLMG	Helemano silty clay, 30-90% slopes	Severe on 30-90% slopes
KtC	Kolokahi clay, 6-12% slopes	Severe: slow and moderately slow permeability; seepage
KTKE	Kokokahi very stony clay, 0-35% slopes	Severe: slow and moderately slow permeability; seepage
MnC	Mamala stony silty clay loam, 0-12% slopes	Severe: coral at a depth of less than 20 inches; stony
PYD	Papaa clay, 6-20% slopes	Severe: slow permeability; slopes generally more than 10%
PYE	Papaa clay, 20-35% slopes	Severe: slow permeability; slopes generally more than 10%
PYF	Papaa clay, 35-70% slopes	Severe: slow permeability; slopes generally more than 10%

Source: U.S. Dept. of Agriculture Soil Conservation, 1972.

Protection Guidelines (Mink et al., 1990). Three principal aquifers occur in the Waimanalo planning area as follows:

- High-level unconfined dike aquifer (corresponds to the high level water in dike-intruded lava flows in the upper mountain region hydrologic unit).
- Basal confined dike aquifer (corresponds to the basal water in dike complexes in the coastal area hydrologic unit).
- Basal unconfined sedimentary aquifer (corresponds to basal water in coastal plain sediments hydrologic unit).

A summary of the classifications for the three principal aquifers is presented in Table 3-2. A conceptual diagram showing the aquifers in relation to potable water wells and tunnels, wastewater effluent injection wells, and cesspools is presented in Figure 3-7.

3. Characteristics of Principal Aquifers

a. High-level Unconfined Dike Aquifer

The groundwater behavior of the aquifer in the Waimanalo planning area is typical of dike-impounded aquifers along the Koolau Range. The groundwater elevation profile steadily decreases in the north-to-south direction. Between Maunawili and Waimanalo valleys, a step increase in water level of about 100 feet occurs. Water levels exceed 600 feet above sea level in this section. High-level groundwater steadily leaks from storage into the downgradient basal groundwater bodies or into streams and springs that cut into the dike-impounded aquifer. Groundwater flow direction is generally east toward the coastline. There are four active BWS potable water tunnels which withdraw high level groundwater from the Waimanalo area.

b. Basal Confined Dike Aquifer

The basalt consists of interbedded pahoehoe and a'a lava flows, with numerous openings available for groundwater storage and flow. The basalt formation therefore creates conditions suitable for a highly permeable aquifer, capable of storing a great deal of fresh water. Groundwater flowing down from the high level unconfined dike aquifer is the source for the basal confined dike aquifer. The basal confined aquifer is crosscut by vertical dikes of much less permeable dikes, which partially confine the groundwater in tall compartments bounded at the top by overlying alluvium and other

**TABLE 3-2
AQUIFER CLASSIFICATIONS IN WAIMANALO PLANNING AREA**

	High-Level Unconfined	Basal (Lower) Confined Aquifer	Basal (Upper) Unconfined Aquifers
Geology	Dike	Dike	Sedimentary
Development Stage	Currently Used	Currently Used	Currently Used
Utility	Drinking	Drinking	Ecologically Vital
Salinity (mg/L as Cl)	<250	<250	250-1,000
Uniqueness	Irreplaceable	Irreplaceable	Irreplaceable
Vulnerability to Contamination	High	Low	High

Source: Mink et al., 1990.

DATE: 01/05/98 P.M. MS
SCALE: 1"=1500' OPER: SHA
FILE: 9524-87 REVISED: 4/10/98

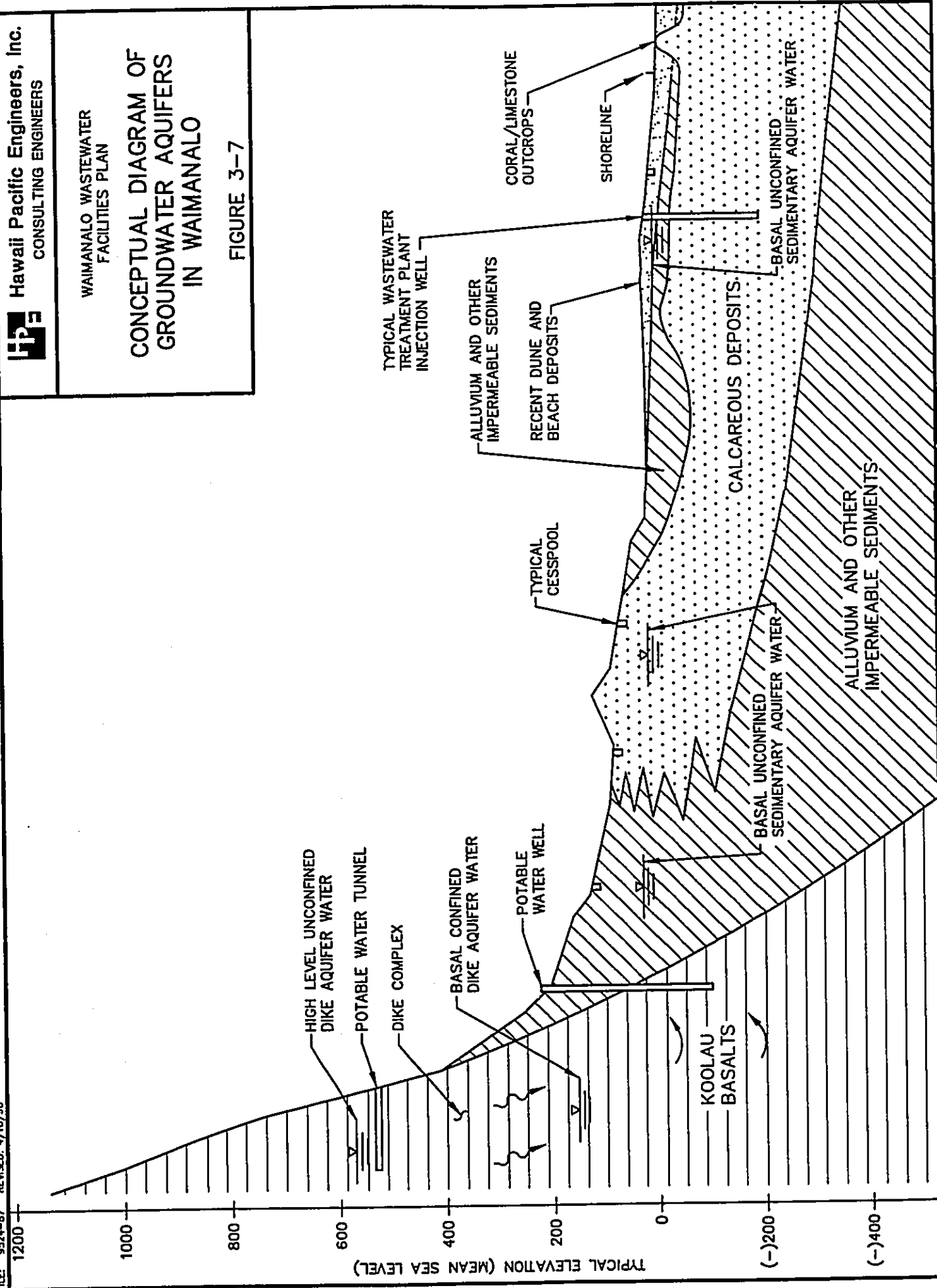

FIGURE 3-7

HPE Hawaii Pacific Engineers, Inc.
CONSULTING ENGINEERS

WAIMANALO WASTEWATER
FACILITIES PLAN

CONCEPTUAL DIAGRAM OF GROUNDWATER AQUIFERS IN WAIMANALO

nearly impermeable sediments. Groundwater leaks horizontally out of the compartments and seeps through the basalt to the coast.

A very small amount of fresh water is thought to flow vertically up from the basalt aquifer to brackish water in the overlying calcareous aquifer (Mink et al., 1990). The flow may be caused by the pressure in the confined aquifer creating very slight flow through the overlying sediments. The flow keeps brackish water in the sedimentary aquifer from flowing down into the underlying basal confined dike aquifer. It also prevents any contaminants or bacteria in the calcareous aquifer from entering the basal confined dike aquifer.

The basal confined aquifer is currently used as a drinking water source (Mink et al., 1990). The BWS maintains one active well (Waimanalo Well II) at the foot of the Koolaus, approximately two miles from shore (see Figures 3-4 and 3-7). The BWS has plans to activate another well (Waimanalo Well III) located slightly more than one mile inland toward the eastern end of the planning area.

c. Basal Unconfined Sedimentary Aquifer

Groundwater occurs near sea level in the uppermost unconfined coastal aquifer. This sand aquifer is about 20 to 30 feet thick. Groundwater flux per 1,000 feet of shoreline is estimated to range between a low of 28,000 gallons per day (gpd) to a high of at least 56,000 gpd (Takasaki et al., 1982). Groundwater flow is generally toward the shoreline.

Two pump tests were conducted in a temporary hole tapping this shallow aquifer in 1981. For the first test the permeability was estimated to be at least 200 feet per day. For the second test the permeability was estimated to be about 100 feet per day (Takasaki et al., 1985)

The upper layer of alluvium and other impermeable sediments is generally not capable of transmitting significant amounts of water. The calcareous sediments in the underlying aquifer is very permeable and capable of transmitting large amounts of water. Below the aquifer is another layer of relatively impermeable sediments which will not transmit significant amounts of water and acts as a basal confining layer to the overlying calcareous aquifer. The calcareous aquifer extends inland to approximately the 40-foot elevation contour (Mink et al., 1990). This aquifer receives effluent from the Waimanalo Wastewater Treatment Plant (WWTP) between approximately 70

and 190 feet below sea level. Groundwater flow is generally toward the shoreline.

Tests conducted in 1996 on monitoring wells in the vicinity of the beach lots showed that the upper unconfined aquifer is comprised primarily of fresh water. Analyses indicated that salinity ranged between approximately 0.56 and 2 parts per thousand (ppt) (or approximately 300 and 1,000 mg/L as chlorides) (Hoover, et al., 1997).

The calcareous aquifer in the lower stratum is brackish with chloride concentrations exceeding drinking water standards. Salinity measurements in 1994 at three new Waimanalo WWTP injection wells penetrating the calcareous aquifer showed that salinity ranged from approximately 14 to 32 ppt (or approximately 7,700 to 18,000 mg/L chlorides) prior to any wastewater injection (Masa Fujioka and Associates, 1994).

Streams

1. Description

Three major streams drain a large portion of the planning area: Waimanalo Stream, Inoaole Stream and Muliwaiolena Stream (see Figure 3-8). Kahawai Stream joins Waimanalo Stream in the vicinity of Kalaniana'ole Highway. In general, the portions of these streams that are inland of Kalaniana'ole Highway are owned and maintained by the State of Hawaii whereas the portions seaward of the highway fall under the jurisdiction of the City and County of Honolulu.

The drainage basin for the Waimanalo Stream system is bounded by the Koolau Range, Aniani Nui Ridge and Waimanalo Bay. It encompasses a total area of approximately 4.9 square miles. This stream system is a network of water courses, including Waimanalo and Kahawai streams, draining into Waimanalo Bay. Two irrigation reservoirs, designated as the Kailua and Maunawili reservoirs, are situated in the upper basin area. Waimanalo Stream is perennial and measurements collected at a U.S. Geological Survey (USGS) gaging station located along its middle reach indicate an average flow of 5.0 cubic feet per second for the period of record.

The Inoaole Stream system drains 3.3 square miles of land. Inoaole Stream is intermittent and the portion that lies in the flat coastal plains region of Waimanalo is affected by the ocean tides.

DATE: 01/05/98 PM: RMA
 SCALE: 1" = 4000' OPER: SHA, CDK
 FILE: 9524-90 REVISED: 4/23/98

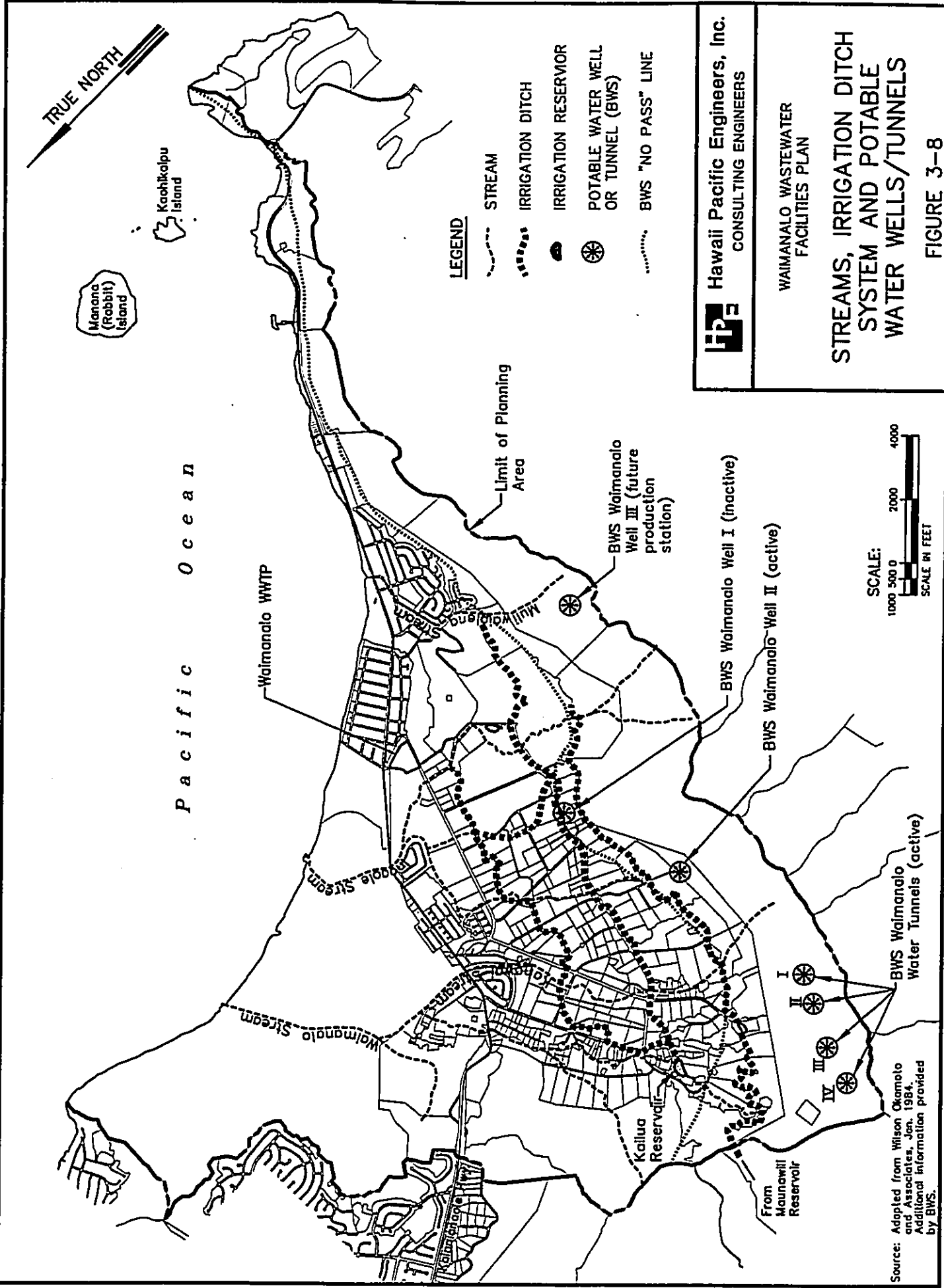

HP Hawaii Pacific Engineers, Inc.
 CONSULTING ENGINEERS

The Muliwaiolena Stream system drains approximately 0.7 square miles of land. Muliwaiolena Stream is intermittent and the portion that lies in the flat coastal plains region is also affected by the ocean tides.

There are no designated wild, scenic, or recreational river areas in the Waimanalo planning area, as defined under the Federal Wild and Scenic Rivers Act.

Aquatic biota in the Waimanalo streams are discussed in the next section of this chapter.

Background information on water quality standards for streams is presented in Appendix B. The water quality of streams in Waimanalo is discussed below.

2. Physical and Chemical Water Quality of Streams

Field investigations of the physical and chemical parameters of Waimanalo Stream were performed in 1994 and 1995 by the "Waimanalo Stream Team" comprised of Waimanalo residents (Department of Health, 1997). The objective of the study was to gather water quality baseline data for temperature, dissolved oxygen, pH, and nitrate concentrations at four locations. The locations of the stream sampling stations are shown on Figure 3-9.

The results of the investigations are presented in Table 3-3. Aside from higher temperatures during "dry" conditions, no discernable patterns were observed between "wet" and "dry" seasons as defined in the DOH Chapter 54, "Water Quality Standards," of the Hawaii Administrative Rules (see Appendix B for background information on the regulations). For this reason and due to the limited number of samples, the data has not been summarized by wet and dry seasons.

For the January 14, 1995 sampling date, an expanded sample set including nitrate-nitrite nitrogen, total nitrogen and total phosphorous was collected at the four Waimanalo Stream sites. The additional samples were collected and analyzed by the University of Hawaii Sea Grant Extension Service. Table 3-4 summarizes the results of the expanded analyses.

Waimanalo-Nonokio rainfall gage records from the National Climatic Data Center indicate that weather on the sampling dates was dry with the exception of January 14, 1995. On this date, 0.10 inch of rainfall was recorded over 24 hours. The data therefore represents dry weather rather than wet weather conditions.

DATE: 3/10/97 MS
 SCALE: 1"=3000' OPER: SHA
 P.L.E. 9524--55A REVISED: 4/10/98

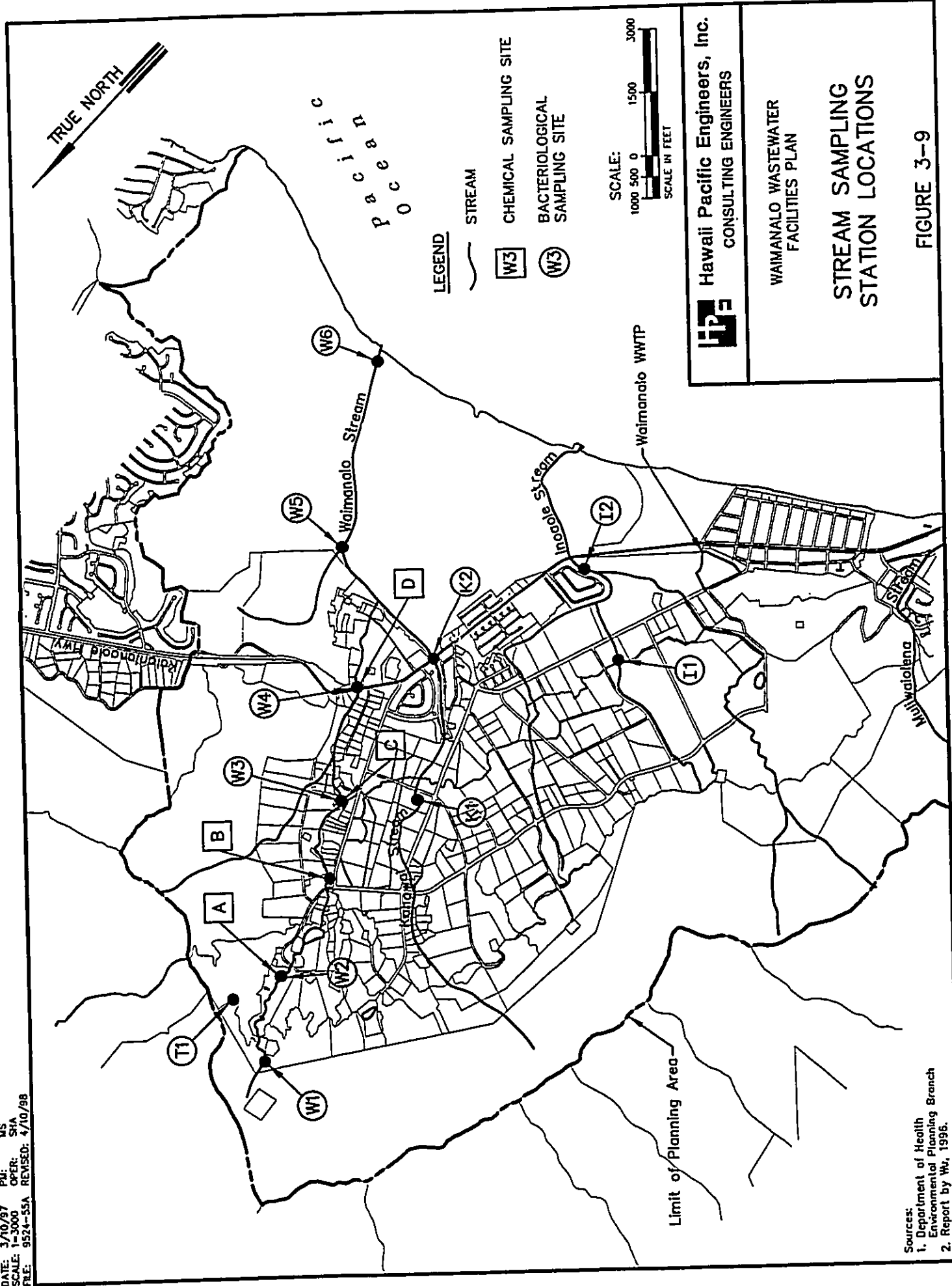

Sources:
 1. Department of Health
 Environmental Planning Branch
 2. Report by Wu, 1996.

HPE Hawaii Pacific Engineers, Inc.
 CONSULTING ENGINEERS

WAIMANALO WASTEWATER
 FACILITIES PLAN

**STREAM SAMPLING
 STATION LOCATIONS**

FIGURE 3-9

**TABLE 3-3
WAIMANALO STREAM MEAN PHYSICAL/CHEMICAL DATA SUMMARY¹**

Location	Temperature, °C				Dissolved Oxygen, mg/L				pH				Nitrate, ² mg/L-N			
	No. Samples	Geom. Mean	High	Low	No. Samples	Geom. Mean	High	Low	No. Samples	Geom. Mean	High	Low	No. Samples	Geom. Mean	High	Low
Site A (near Olomana Ranch)	5	23	25	20	6	8.8	9.5	8.5	7	7.5	7.5	7.5	5	0.05	0.26	0.00
Site B (bridge at Waikupanaha St. and Kumuhau St.)	5	23	26	21	6	7.1	8.3	6.3	7	7.5	7.5	7.5	5	1.14	1.80	0.66
Site C (Kumuhau St. 0.5 miles from Highway)	6	25	28	21	6	9.1	10.0	8.0	8	7.5	7.5	7.5	5	2.95	3.50	2.30
Site D (makai of Kalaniana'ole Highway)	6	29	34	23	6	15.2	17.5	11.8	8	8.6	9.5	7.5	5	1.27	2.42	0.86

Notes:

1. Data is based on 8 sample dates starting on 6/17/94 and ending on 1/14/95. Not all parameters sampled on all dates.
2. Nitrate nitrogen data, reported in terms of nitrate in the original data set, has been converted to nitrate as nitrogen in the table. Nitrate sample for Site A on 7/19/94 reported as 0. Detection limits of analysis were not provided. Nitrogen value of 0.001 mg/L assumed for geometric mean calculation purposes.

**TABLE 3-4
WAIMANALO STREAM EXPANDED PHYSICAL/CHEMICAL DATA SUMMARY¹**

Location	Temp, ³ °C	Dissolved O ₂ , ³ mg/L	pH ³	Nitrate ^{2,3} mg/L-N	Nitrate + Nitrite ⁴ mg/L-N	Total Nitrogen ⁴ mg/L-N	Total Phosphorus ⁴ mg/L
Site A (near Olomana Ranch)	20	9	-	0.06	0.03	0.08	0.03
Site B (bridge at Waikupanaha St. and Kumuhau St.)	21	8	-	0.25	0.22	0.29	0.03
Site C (Kumuhau St. 0.5 miles from Highway)	21	9	7.5	0.73	0.62	0.78	0.02
Site D (makai of Kalaniana'ole Highway)	23	15	-	0.21	0.47	0.59	0.01

Notes:

1. Data is based on a single sample set taken on 1/14/95.
2. Nitrate nitrogen data, reported in terms of nitrate in the original data set, has been converted to nitrate as nitrogen in the table.
3. Sample analysis by Waimanalo Stream Team.
4. Sample analysis by University of Hawaii Sea Grant Extension Service.

Chapter 54 specifies a dry and wet season stream water quality criteria of 0.007 and 0.030 mg/L-N geometric mean respectively for nitrite plus nitrate. Chapter 54 also specifies stream water quality criteria of 0.30 and 0.17 mg/L-N nitrite plus nitrate "not to be exceeded more than 2 percent of the time" limits for wet and dry seasons, respectively. As shown in Table 3-3, each of the four sampling locations had geometric mean nitrate concentrations that exceed the allowable mean nitrite plus nitrate concentration for the higher "wet" criteria. All the sampling stations with the exception of Station A had values exceeding the "not to be exceeded more than 2 percent of the time" criteria.

With the exception of Station A, all the values for total nitrogen from the expanded analysis shown on Table 3-4 exceeded both the wet and dry season geometric mean criteria of 0.18 and 0.25 mg/L-N, respectively. Stations C and D also exceeded the "not to be exceeded more than 10 percent of the time" total nitrogen criteria of 0.52 and 0.38 mg/L-N, respectively.

As shown of Table 3-4, Chapter 54's total phosphorous dry season geometric mean criteria of 0.080 mg/L was not exceeded by the sampling program total phosphorous data. The total phosphorous concentration were slightly lower for the downstream sampling stations whereas the nitrogen concentrations were much higher for the downstream stations. The nitrogen to phosphorous ratio is typically 16 to 1 for phytoplankton (Brock 1979; Laws, 1997). For macro algae, the nitrogen to phosphorous ratio may vary with the species but may be on the order of 25 to 1 (Laws, 1997). Based on the limited data presented in Table 3-4, it appears that nitrogen may be the limiting nutrient in the upstream areas, but phosphorous may become the limiting nutrient at downstream locations due to the presence of high nitrate levels.

Waimanalo Stream was one of four water bodies in the state designated as being "severely impaired" by DOH in its Water Quality-Limited Waters (WQLW) Assessment (DOH, 1997). Poor aesthetic conditions are created in the shoreline area by the stream. The nitrogen levels in Waimanalo Stream clearly exceed the State water quality criteria. The high nitrogen concentrations may be promoting algal blooms observed at the mouth of the stream particularly if phosphorous is no longer the limiting nutrient due to mixing of stream and coastal waters. Anecdotal information indicates that leachates and direct overflows from some cesspools located near streams in Waimanalo are currently entering the streams.¹

¹This observation was made by Ms. Darla Inglis, a University of Washington graduate student who inspected cesspool systems of some of the homes near the stream in 1996. Ms. Inglis was investigating potential groundwater monitoring sites for a research project that was eventually abandoned.

3. Bacteriological Water Quality of Streams

Investigations on the baseline bacteriological water quality of streams in Waimanalo were performed in 1993 and 1994 by researchers at the University of Hawaii (Wu, 1996). The objectives of the study were as follows:

- To characterize the bacterial occurrences (fecal coliform, E. coli, enterococci, and Clostridium perfringens) and physical parameters (pH, turbidity, and salinity) within Waimanalo Stream, and waters off Waimanalo Beach.
- To characterize the effect of rain events on the bacterial and physical characteristics of water in the Waimanalo watershed.

As part of a bacteriological water quality study, eleven stream sampling sites were established. The locations of these sampling sites at Anianinui Tunnel (irrigation water) and along Waimanalo Stream, Kahawai Stream and Inoaole Stream are shown on Figure 3-9 (Wu, 1994). Regular sampling was limited to Waimanalo Stream since other streams in Waimanalo are intermittent.

The concentrations of fecal coliform, E. coli, enterococci and Clostridium perfringens were periodically sampled and analyzed from July 1993 through June 1994. The results of the work are summarized on Table 3-5. The study indicates that fresh waters in Waimanalo in most cases do not conform to current state and federal bacteriological water quality standards for fecal coliform, E. coli, and enterococci. The geometric mean standards of 200 CFU/100 mL for fecal coliform and 126 CFU/100 mL for E. coli were exceeded at 9 of the 11 sites. The enterococci standard of 33 CFU/100 mL was exceeded at 10 of the 11 sites. At some locations, the standards were far exceeded. At the "K2" Kahawai stream site, the E. coli geometric mean concentration was two orders of magnitude higher than the standard. The proposed C. perfringens standard of 50 CFU/100 mL was met at 8 of the 11 sampling stations.

In general, the concentration of all indicator bacteria rose with downstream travel to the point where Kahawai Stream joins Waimanalo Stream and then decreased further downstream toward the shoreline. The researchers attribute the decrease in indicator bacteria downstream of Kahawai Stream juncture to dilution, increased salinity, and sunlight. Bacteria are sensitive to changes in osmotic pressure, and the researchers note that previous studies have shown that death rates of E. coli and enterococci increase with increasing salt water concentration. Ultraviolet radiation in sunlight damages the DNA of cells.

**TABLE 3-5
WAIMANALO STREAM MEAN BACTERIOLOGICAL DATA SUMMARY¹**

Location	No. Samples	Fecal Coliform, CFU/100 mL			<u>E. Coli</u> , CFU/100 mL			Enterococci, CFU/100 mL			<u>Clostridium Perfringens</u> , CFU/100 mL		
		Geom. Mean	High	Low	Geom. Mean	High	Low	Geom. Mean	High	Low	Geom. Mean	High	Low
Site T1, Anianinui Tunnel, Waimanalo side of Anianinui Ridge	11	1,021	7,120	360	985	6,240	328	923	2,600	212	20	230	6
Site W1 (Waimanalo Stream 0.25 mi. upstream of Olomana Ranch)	4	635	2,160	256	859	2,240	344	195	1,440	60	1	4	1
Site W2 (Waimanalo Stream near Olomana Ranch)	14	2,014	69,600	656	2,382	64,400	680	1,269	104,000	252	10	4,000	1
Site W3 (Waimanalo Stream at Kumuhau St. 0.5 mile from Highway)	12	3,417	136,000	880	3,428	108,000	987	3,377	288,000	1,120	54	2,800	20
Site W4 (Waimanalo Stream at Kalamanaole Highway)	12	3,739	136,000	1,760	3,329	140,000	1,160	2,787	280,000	1,160	41	2,000	2
Site W5 (Waimanalo Stream at Tinker Road, Bellows AFS)	6	5,859	20,000	1,840	5,377	10,800	1,280	3,109	7,600	1,040	61	160	15
Site W6 (Waimanalo Stream 100 yards from mouth)	2	648	920	456	930	1,080	800	330	440	248	8	9	7
Site K1 (Kahawai Stream at Mahailua St. near Kakaina St.)	1	40	40	40	80	80	80	480	480	480	1	1	1

**TABLE 3-5
WAIMANALO STREAM MEAN BACTERIOLOGICAL DATA SUMMARY (Continued)**

Location	No. Samples	Fecal Coliform, CFU/100 mL			E. Coli, CFU/100 mL			Enterococci, CFU/100 mL			Clostridium Perfringens, CFU/100 mL		
		Geom. Mean	High	Low	Geom. Mean	High	Low	Geom. Mean	High	Low	Geom. Mean	High	Low
Site K2 (Kahawai Stream at Kalaniana'ole Highway near Frankies Drive In	12	20,515	300,000	3,080	19,584	272,000	2,800	18,327	930,000	2,280	663	6,000	162
Site I1 (Inoaole Stream at Hihimanu St.)	1	144	144	144	108	108	108	32	32	32	8	8	8
Site I2 (Inoaole Stream at Kalaniana'ole Highway)	2	4,912	23,200	1,040	2,800	14,000	560	10,940	27,200	4,400	13	56	3

Notes:

1. Data is based on 14 sample dates starting on 7/19/93 and ending on 6/27/94. Not all dates sampled at all sites. On dates sampled all four indicator bacteria analyses were performed.
2. CFU: Colony forming units
3. Source: "Assessing the Water Quality of the Waimanalo Watershed by Measuring Indicator Bacteria Densities in Waimanalo Stream and in Waimanalo Bay," Arvin C. Wu, 1994 draft paper submitted to the graduate division of the University of Hawaii School of Public Health in partial fulfillment of the requirements for the degree of Masters of Public Health.
4. Fresh Water Bacteriological Standards (geometric mean):
 Fecal coliform (State, HAR Chapter 11-54): 200 CFU/100 mL
 E. Coli (EPA, recreational fresh waters): 126 CFU/100 mL
 Enterococci (EPA, recreational fresh waters): 33 CFU/100 mL
 Clostridium perfringens (State, proposed): 50 CFU/100 mL

Shaded numbers indicate that the computed geometric means exceeds the above standards.

The effect of a rain event on bacterial concentrations was observed following a rain event on September 26, 1993. At all the sites, the indicator bacteria concentrations following the rain event increased by more than a factor of 100 over the geometric mean concentrations. A total of 2.0 inches of rain was received at the National Climatic Data Center Waimanalo Nonokio rain gage (No. 795.2) in 24 hours.

The researchers attributed the presence of fecal indicator bacteria in the streams as most likely due to the bacteria naturally present in the soils throughout the area. The temperature, moisture and nutrient conditions in the soils were felt to be well within the tolerances of most fecal indicator bacteria to allow the bacteria to thrive. Potential sources of pollution noted by the researchers included surface and groundwater flow from irrigation of farm land, flows from the Waimanalo irrigation system located in the Waimanalo Stream drainage, and domestic and feral animal wastes. Noncompliance with bacteriological standards occurred at upstream sampling stations where no sewage contamination would be expected. The possible exfiltration of sewers into streams at downstream locations is mentioned although no evidence was available to support this. Other reports have mentioned cesspool effluent as a potential source of indicator bacteria (Thompson, 1993). As mentioned above, leachates and direct overflows from cesspools have been observed entering the Waimanalo Stream. Based on available information, the relative impact of the various contamination sources is somewhat uncertain.

Wetlands

The wetlands area in Waimanalo consists primarily of palustrine emergent wetlands created by impoundments in the agricultural areas. The wetland areas are defined by the classification system prepared by the U.S. Fish and Wildlife Service. These impoundments are used to hold irrigation water from the Waimanalo Ditch system. The approximate combined area of the impoundment wetlands is 103 acres.

The wetlands area at Bellows AFS is categorized as a secondary area for endangered water birds (Belt Collins Hawaii, 1995a). *Secondary areas are areas where a smaller number of birds exist.* Currently, the wetlands are managed for endangered water birds through a cooperative agreement between the U.S. Fish and Wildlife Service, State Department of Land and Natural Resources, and U.S. Air Force. The approximate area of the site, consisting of ditches, streams and adjoining marsh lands, is 56 acres.

The soil categories of the U.S. Department of Agriculture, Natural Resources Conservation Service (formerly the Soil Conservation Service) identifies the HeA, HnA

and the HnB soil types along Waimanalo Stream as potential wetland areas (Smith, 1996). The location of these soil types for the study area are shown on Figure 3-5 and descriptions are included in Table 3-1.

Coastal Waters

1. Description

The Waimanalo region is well known among local residents and visitors for its beaches and recreational waters. The coastal waters are used for swimming, surfing, fishing and other shoreline recreational activities.

Waimanalo Beach, stretching approximately 5.5 miles between Wailea Point and Makapuu Point, is the longest continuous sand beach on the island of Oahu. The beach is stable and subject to only relatively small seasonal changes.

Waimanalo Bay is protected by a barrier reef that lies approximately one mile offshore, except at the southeast end, where the reef is about 500 yards from shore. The central portion of the reef is about 10 to 12 feet deep, but at the northwest and southeast end, the reef is relatively shallow. Numerous rip channels cut through the reef. There are areas of sand deposits and patches of coral reef within the bay. Major features include a sand channel across the northern portion of the bay and a sand reservoir offshore from the Bellows AFS. Beyond the reef, the ocean bottom drops off fairly uniformly and rapidly. The general bathymetry of the bay was previously shown on Figure 3-3.

The significant wave heights at Waimanalo Bay may range from 1 to 13 feet, with a mode of three feet (Belt Collins Hawaii, 1995a). Wave conditions range in period from 6 to 18 seconds.

Water circulation within Waimanalo Bay is complex and does not follow a specific pattern. Northwesterly currents prevail over most of the outward portion of the bay; however, the currents reverse at times, especially in shallow water. Circulation within the bay is weak and has a negligible influence on sand transport. Wave-induced currents in the surf zone, however, have a significant influence on sediment transport.

Aquatic biota in the Waimanalo coastal waters are discussed later in this chapter.

Background information on water quality standards for coastal waters is presented in Appendix B. The water quality of coastal waters in Waimanalo is discussed below.

2. Physical and Chemical Water Quality of the Coastal Waters

The Clean Water Branch of the DOH manages a program of regular sampling and water quality testing for Waimanalo Bay. The locations of the 13 existing shoreline sampling stations located between Bellows AFS and Makapuu Beach Park are shown on Figure 3-10. The sampling stations clustered in the Bellows AFS were originally used by the military and then later taken over by the DOH.

Due to *DOH* budget limitations, samples from only one of the DOH sampling sites, Bellows No. 4, are currently analyzed for the full range of physical and chemical parameters. This site is sampled and tested for temperature, dissolved oxygen, turbidity, nitrate-nitrite, ammonia nitrogen, total kjeldahl nitrogen, total nitrogen, total phosphorus, orthophosphorus, pH, total suspended solids, and chlorophyll a on a monthly basis. The purpose of the water chemistry testing program at Bellows No. 4 is primarily to assess the impact of Waimanalo Stream on nearshore water quality. The available records between October 1995 and *July 1997* for 17 sampling cycles are shown in Table 3-6.

The data in Table 3-6 shows that there are some problems with analytical detection limits for some of the constituents relative to the receiving water quality standards. The detection limit exceeds the water quality criteria for ammonia nitrogen, nitrate + nitrite nitrogen, and chlorophyll a.² Ideally, the detection limit should be substantially lower than the applicable criteria. The ammonia concentration was always lower than the detection limit. The other constituents typically displayed a wide range between the maximum and minimum, with the concentration of a number of samples being below the detection limit. For the purposes of analysis, the geometric mean was calculated by treating the values less than the detection limit as equal to the detection limit. The calculated geometric mean values are overstated when using this method.

The expanded shoreline monitoring program at the Bellows No. 4 sampling station began in 1995. The data is indicative of only a single sampling location and may not be representative of conditions in Waimanalo Bay as a whole. The data collected to date at Bellows No. 4, however, indicate that the mean values for nearshore waters at this station are not in compliance with the State's open coastal receiving water standards. Parameters that exceed the standards include turbidity, nitrate-nitrite nitrogen, orthophosphorous, and chlorophyll a. In

²DOH Water Quality Lab personnel indicated that nitrogen and phosphorous analysis limits are currently limited by the use of EPA approved colometric methods. There are future plans to utilize non-EPA approved methods if sufficient funding is available.

DATE: 10/18/95
 SCALE: 1"=1000'
 FILE: 9524-3JA

AS
 SIA
 REVISION: 4/10/98

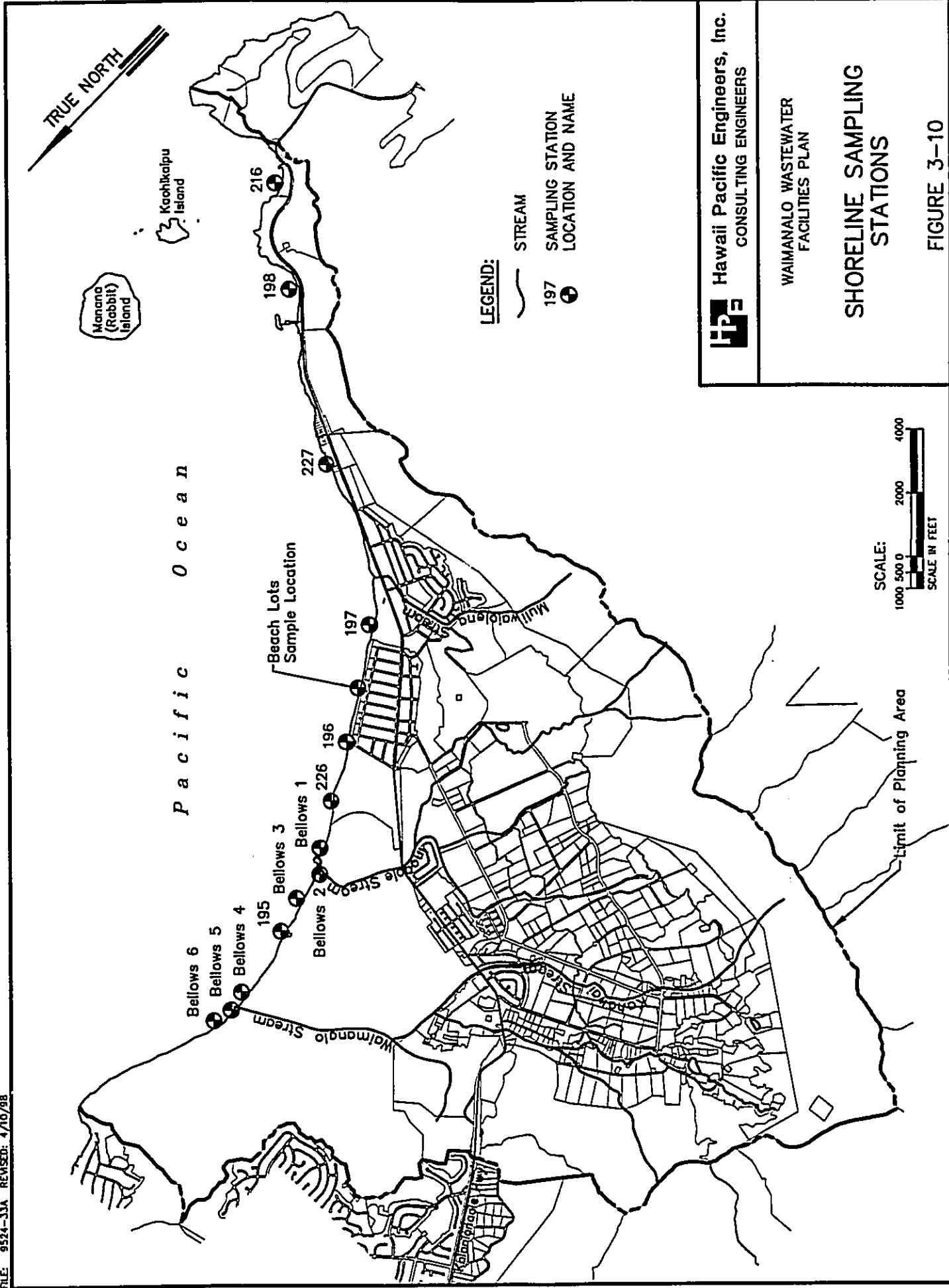

HPE Hawaii Pacific Engineers, Inc.
 CONSULTING ENGINEERS

WAIMANALO WASTEWATER
 FACILITIES PLAN

**SHORELINE SAMPLING
 STATIONS**

FIGURE 3-10

**TABLE 3-6
WAIMANALO BAY STATION NO. 4 WATER QUALITY DATA**

Parameter	Geometric Mean ¹	Minimum ¹	Maximum ¹	Ch. 54 "not to exceed" geometric mean ³
Temperature, °C	25	22	28	-
Dissolved Oxygen, mg/L	6.8	6.4	7.1	5.0 ³
Turbidity, NTU	3.8	1.9	8.1	2
Ammonia Nitrogen, mg/L-N	<0.5	<0.5	<0.5	0.0035
Nitrate + Nitrite Nitrogen, mg/L-N ⁴	0.054	<0.01	0.28	0.005
Kjeldahl Nitrogen, mg/L-N ⁴	0.14	<0.1	0.3	0.15
Total Nitrogen, mg/L-N ⁴	0.194	<0.10	0.48	-
Total Phosphorous, mg/L-P	0.024	0.007	0.104	0.02
Orthophosphate, mg/L-PO ₄ ⁴	0.014	<0.005	0.08	0.007
pH	8.2	8.2	8.2	-
TSS, mg/L	20	12	34	-
Chlorophyll <i>a</i> , µg/L ⁴	40	<2.5	1121	0.3

Notes:

1. Water quality data from State of Hawaii Department of Health, Clean Water Branch. Records for Monitoring Station No. 4 include 17 sampling cycles from October 1995 through July 1997.
2. The "wet" criteria for open coastal waters from the State of Hawaii Department of Health Chapter 54, "Water Quality Standards" of the Hawaii Administrative Rules are shown in the table. See Appendix B.
3. Dissolved oxygen standard based on 75 percent of calculated saturation value at mean temperature and salinity.
4. For calculation of the geometric mean, observations recorded as less than the detection limit were treated as equal to the detection limit. The resultant geometric mean is therefore higher than the true geometric mean.

particular, the mean values for nitrate plus nitrate nitrogen and chlorophyll a are more than one order of magnitude higher than the standard.

Chlorophyll a is a pigment that is commonly used as an indicator for the presence of algae. It is found in virtually all species of algae, so it does not distinguish between any particular species of algae. One criterion used to evaluate the level of eutrophication based on chlorophyll a concentrations (Laws, 1993) is as follows:

<u>Algae status</u>	<u>Chlorophyll a concentration, $\mu\text{g/L}$</u>
Extreme blooms	≥ 100
Blooms	10-25
Eutrophic	1-10

Based on a geometric mean of 40 $\mu\text{g/L}$ for chlorophyll a computed from the available data, the shoreline waters in the vicinity of Bellows No. 4 appear to be experiencing extreme bloom conditions a considerable portion of the time. This condition is likely to be caused in part by nutrients, particularly phosphorous (the probable limiting nutrient) and nitrogen, carried with runoff into Waimanalo Stream from a variety of sources. Many respondents to a survey of individual wastewater system users in the coastal area indicated that they have observed algae blooms in the nearshore waters, particularly after heavy rains.

As part of the Waimanalo Facilities Plan project, sampling was performed on December 17, 1996 at a non-DOH station located in the area fronting the unsewered beach lot homes (see Figure 3-10) and for two of the DOH sampling stations (Station Nos. 195 and 196). The samples were analyzed for nitrate + nitrite and chlorophyll a. The intent of this investigation was to determine if nitrogen and chlorophyll concentrations might be noticeably higher near the beach lot homes due to the heavy concentration of individual wastewater systems in the area. The weather on the day of the sampling was dry. The results of the investigation are as follows:

Sample Location	Nitrate + Nitrite, mg/L-N	Chlorophyll <u>a</u> , $\mu\text{g/L}$
DOH No. 195	<0.050	0.17
DOH No. 196	<0.050	0.28
Beach Lot	0.051	0.32
Chapt. 54 Standards (geometric mean for "dry")	0.110	0.15

The concentration of nitrate + nitrite (0.051 mg/L-N) for the beach lot sample was just slightly over the detection limit (0.050 mg/L-N), but below the Chapter 54 limit (0.110 mg/L-N). The nitrate + nitrite concentration for the DOH station samples were below the detection limit. The chlorophyll a concentrations for all three samples (which had a geometric mean of 0.25 $\mu\text{g/L}$) were above the Chapter 54 limit of 0.15 $\mu\text{g/L}$ but well below what would be considered eutrophic. The limited sampling data would seem to indicate that individual wastewater systems may not have a significant impact during dry weather.

Additional data would be required to determine if the individual wastewater systems in the beach lot area are in fact having a significant impact on water quality in the area. Nitrogen levels following inclement weather would be of particular interest since a significant amount of soluble nitrates may enter the ocean as a result of increased groundwater flow. Elevated nutrient levels, however, may also result from surface runoff flow. The contribution of phosphorous, the probable limiting nutrient, from surface runoff would be of particular interest since groundwater is typically low in phosphorous. It would be prudent for DOH to include a sampling station fronting the beach lot area and a control station at another location in its water quality sampling program. This would establish a more comprehensive baseline data base and better evaluate the impact of individual wastewater systems in the beach lot area on water quality. The impact of the beach lot area individual wastewater systems on groundwater quality is discussed further in Chapter 5.

3. Bacteriological Water Quality of Coastal Waters

Eleven shoreline sites within the study area are sampled approximately biweekly for fecal coliform bacteria, enterococci bacteria and salinity. The results of the nearshore bacteriological and salinity sampling program are summarized on Table 3-7. In the marine environment, the enterococci test is a more reliable indicator of pollution than the fecal coliform test due to the generally greater ability of enterococci to survive in the adverse saline environment.

The bacteriological data shows that the stations adjacent to Waimanalo Stream and Inoaole Stream (Bellows No. 2 and No. 5) have by far the highest average enterococci bacteria counts. Geometric mean enterococci concentrations at these two stations exceed the Chapter 54 limit of 7 CFU/100 mL by a wide margin.

This data confirms that streams are a significant source of bacteriological pollutants to nearshore waters. There is a strong correlation at all of the stations with respect to heavy rainfall, increased bacterial counts and decreased salinity. Increased bacteria counts resulting from stormwater runoff may be due to a

**TABLE 3-7
WAIMANALO BAY SHORELINE BACTERIOLOGICAL
AND SALINITY WATER QUALITY DATA**

Location	Fecal coliform, No./100 mL			Enterococci, No./100 mL			Average Salinity, parts per thousand
	Geom. Mean	Min.	Max.	Geom. Mean	Min.	Max.	
Makapuu, No. 216	2	0	50	2	1	26	34
Kaiona Beach, No. 227	3	1	1,600	3	1	1,060	34
Waimanalo Beach, No. 197	3	1	1,600	3	1	560	34
Waimanalo Bay, No. 196	4	1	8,000	2	1	940	34
Waimanalo State Park, No. 226	3	0	1,400	2	1	1,200	34
Bellows No. 1	3	1	21,000	3	1	990	34
Bellows No. 2 (Inoaole Stream)	163	94	610	105	29	1,800	1
Bellows No. 3	3	0	3,500	3	1	4,860	34
Bellows No. 4	15	0	3,400	13	0	3,700	34
Bellows No. 5 (Waimanalo Stream)	364	0	5,500	224	0	6,400	22
Bellows No. 6	5	0	1,300	4	0	850	34
Chapt. 54 Stnds	--	--	--	7	--	--	--

Notes:

1. Water quality data from State of Hawaii Department of Health, Clean Water Branch.
2. Sampling generally performed biweekly. Period of record: Makapuu Beach: 1990-1995, Kaiona Beach: 1989-1995, Waimanalo Beach: 1989-1995; Waimanalo Bay: 1989-1995; Waimanalo State Park: 1991-1995; Bellows No. 1: 1994-1995; Bellows No. 2: 1992-1994; Bellows No. 3: 1992-1995; Bellows No. 4: 1992-1995; Bellows No. 5: 1992-1995; Bellows No. 6: 1992-1995.

number of causes. These include bacteria within the soil being washed away, livestock wastes, other domestic and feral animal wastes, and overflows from cesspools and septic tank systems.

A study of pollution indicator bacteria in Waimanalo Stream documented previous measurements of enterococci densities in the nearshore waters in the vicinity of Bellows AFS (Wu, 1994). Enterococci concentrations were taken by U.S. Air Force personnel over a 30-day time period during October through November 1992. Five-day geometric mean concentrations were as follows:

<u>Location on Bellows AFS Shoreline (see Figure 3-10)</u>	<u>Five-day Geometric Mean Enterococci Concentration (CFU/100 mL)</u>
VIP Cabins (Bellows 6)	5.7
North side Waimanalo Stream (Bellows 5)	7.6
South side Waimanalo Stream (Bellows 4)	25.7
North of Inoaole Stream (195)	10.0

Three of the four sites exceeded the Chapter 54 limit of 7 CFU/100 mL. The same study found that the 5-day geometric mean concentration enterococci in Waimanalo Stream at the point where Kahawai Stream enters was 5,275 CFU/100 mL. The data indicates that there is probably a significant amount of dilution between the stream and shore stations. Die-off of enterococci from the higher salinity ocean water and exposure to sunlight may also be significant. The concentration of the enterococci along the shore is consistent with a north-to-south circulation pattern along the shore of Waimanalo Bay.

Natural Hazards

1. Seismic Hazards

Oahu has experienced a number of earthquakes in recent recorded times. Most earthquakes felt on Oahu are centered near the island of Hawaii and cause no damage on Oahu. In the spring of 1948, an earthquake of 4.8 magnitude, centered slightly off the coast of Oahu resulted in broken windows in downtown Honolulu (Macdonald et al., 1983). In 1978 an earthquake of 4.2 magnitude was centered on the north shore of Oahu, again causing little or no damage on Oahu.

2. Flooding and Tsunami Hazards

Flooding of large areas in Waimanalo Valley during severe rainstorms has primarily been attributed to the small carrying capacities of streams, inadequate road undercrossings, and low-lying coastal plains. Inundation and flooding in Waimanalo are discussed later in this chapter in the section on drainage facilities.

Waimanalo is located along the southeastern coast of Oahu and is potentially vulnerable to tsunamis from all directions. However, the wide, shallow reef offers good protection to the area. During the major tsunamis that have occurred in Hawaii (1946, 1952, 1960), inundation along the Waimanalo coastline ranged between six and nine feet above the mean lower-low water level. There were no reports of shore erosion or property damage.

BIOLOGICAL ENVIRONMENT

The majority of the information presented below on the biological environment was excerpted from the Final Environmental Impact Statement, Land Use Development Plan, Bellows Air Force Station, prepared by Belt Collins Hawaii (1995a). This reference provided relatively comprehensive and up-to-date information on the biological environment in Waimanalo.

Terrestrial and Freshwater Biota

1. Flora

Flora within the Waimanalo planning area can be generally categorized into three sub-zones: conservation, cultivated plains, and shoreline. The conservation zone, which includes the upper watershed and forest reserve regions, is characterized by panicum, Hilo grass, guava, staghorn fern, ohia, lehua, koa, and honohono grass. The cultivated plains include truck and diversified agricultural crops. The shoreline zone exhibits Kiawe, coconut, ironwood, koa haole, lantana, ilima, pili grass, Bermuda grass, and bristly foxtail.

Six candidate endangered species of plants are known historically from Waimanalo. These plant species are the Coast sandalwood (Santalum ellipticum var. littorale Skotts.), O'ahu vinya (Vigna o-wahuensis Vogel), Kookoolau (Bidens graciloides Sherff), N.C.N. (Lobelia oahuensis Rock), Maiapilo (Capparis sandwichiana DC. var. sandwichiana), and 'Ohai (Sesbania tomentosa H. & A.). However, most of these plants may no longer be present in Waimanalo and those that still persist are not affected by infrastructure construction in developed areas.

2. Fauna

Based on an inventory of fish and wildlife in Waimanalo, the wetlands at Bellows Air Force Station provide habitat for four endangered endemic waterbird species (Belt Collins Hawaii, 1995a; Bruner, 1994). These waterbirds are the Hawaiian Duck (Anas wyvilliana), Hawaiian Coot (Fulica americana alai), Hawaiian Gallinule (Gallinula chloropus sandvicensis), and Hawaiian Stilt (Himantopus mexicanus knudseni).

The endemic Short-eared Owl or Pueo (Asio flammeus sandwichensis) has also been observed at the Bellows AFS (Belt Collins Hawaii, 1995a; Bruner, 1994). The Pueo is listed as an endangered species on Oahu by the State of Hawaii Division of Forestry and Wildlife.

In comments to the DSEIS (see Chapter 10), the U.S. Department of Interior Fish and Wildlife Service indicated that the Service is aware of four species of birds protected by the Migratory Bird Treaty Act that are known to occur along the coastline of Waimanalo Bay. These species include the Pacific golden-plover or Kolea (Pluvialis fulva), the ruddy turnstone or 'Akekeke (Arenaria interpres), the sanderling or Hunakai (Calidris alba), and the wandering tattler or 'Ullili (Heteroscelus incanus).

A variety of other *introduced* bird species has also been observed in Waimanalo Valley, including common mynahs (Acridotheres tristis), barred doves (Geopelia striata), spotted doves (Streptopelia chinensis), Japanese white-eyes (Zosterops japonicus), red-crested cardinals (Paroaria coronata), Nutmeg Mannikins (Lonchura punctulata), red-vented bulbuls (Pychnonotus cafer), house sparrows (Passer domesticus), and cattle egrets (Bubulcus ibis) (Park Engineering, 1982).

Wildlife which typically inhabit the upper watershed region and open agricultural lands include *non-endemic* feral dogs and cats, mongoose (Herpestes auropunctatus), and rats (Rattus exulans hawaiiensis) (Park Engineering, 1982). *Introduced* Jackson chameleons and iguanas are also known to inhabit the area.

Aquatic fauna in Kailua Reservoir and Waimanalo Stream have also been recorded (Park Engineering, 1982). *Introduced* species such as bullfrogs (Rana catesbeiana), tilapia (Tilapia mossambica), and mosquito fish (Gambusia affinis) have been observed in Kailua Reservoir. The aquatic fauna collected in Waimanalo Stream include the *endemic* Hawaiian prawn (Macrobrachium grandimanus) and goby (Awaous stamineus), and the *introduced* Tahitian prawn (Macrobrachium lar), guppy (Poecilia reticulata), and green swordtail (Xiphophorus helleri) (Park Engineering, 1982; U.S. Fish & Wildlife Service, 1978).

The Nature Conservancy's Hawaii Natural Heritage Program database indicated that two endemic species of damselflies, the Blackhook Hawaiian Damselfly (Megalagrion nigrohamatum nigrolineatum) and the Oceanic Megalagrion (Megalagrion oceanicum) have been observed near Waimanalo Stream in the vicinity of the Olomana Golf Links (Asquith, 1997). These two species are currently candidates for listing under the Federal Endangered Species Act.

The endemic and endangered Hawaiian Hoary Bat (Lasiurus cinereus semotus) is known to roost solitarily in trees and occur in upland forests as well as in coastal habitats. Data on the bat's distribution and behavior are extremely limited (Belt Collins Hawaii, 1995a; Bruner, 1994). This species was not listed in the Nature Conservancy's database or indicated to have been observed in Waimanalo in the references reviewed.

The fish and wildlife habitat in the area is not unique. Most of the fauna found in the area are common introduced species, with the exception of the Hawaiian prawn, goby, damselflies, Pueo, and the endangered water birds.

Marine Biota

The coastal waters in Waimanalo Bay constitute a complex ecosystem and host a variety of marine biota. The quantity and quality of marine biota in the bay is indicative of a generally healthy ecological environment. Threatened or endangered species may be found in the bay on occasion.

1. Coral and Macroinvertebrates

The invertebrate community structure of Waimanalo Bay is relatively limited, both in numbers of individuals and in percentage of bottom cover. A survey conducted in 1994 found that only four percent of solids surfaces (which make up half the bay) are covered with living coral, although much of the hard bottom appears to consist of fossil coral reef platforms. Coral coverage is less off Inoaole Stream than in northern areas. The low percentage of living coral suggests that most reef platforms are not actively accreting at present.

2. Algae

Frondose (feather-like) benthic algae were found to be very abundant in transect locations of the survey performed in 1994, except at the station located nearest to Waimanalo Stream. The most abundant species were the red alga Asparagopsis taxiformis (imu kohu) and brown alga (limu kala). Both these species are common in shallow Hawaiian environments; their abundance is greatest in spring and summer and lower in winter.

3. Reef Fish Community Structure

Reef fish community structure is largely determined by the topography and composition of the benthos. Similar to coral, there is a marked decrease in the number of fish species, number of individuals, and species diversity at the southern end of Waimanalo bay compared to the northern part of the bay. The number of individuals was lower than would be expected from a well-developed coral reef habitat, which is consistent with the low coral coverage found in Waimanalo Bay.

4. Endangered and Protected Species

Three species of marine animals that occur in Hawaiian waters have been declared threatened or endangered by the federal government. Threatened green sea turtles (Chelonia mydas) occur commonly in the nearshore areas of Oahu. They are known to feed on selected species of macroalgae, particularly at the mouth of Waimanalo Stream. Several green sea turtles were sighted on the surface and underwater during 1994 surveys in Waimanalo Bay. This area is likely a very popular site for turtle feeding due to the abundant algae resources. The endangered hawksbill turtle (Eretmochelys imbricata) is found infrequently in Hawaiian waters. There are no known turtle nesting sites in Waimanalo Bay.

The National Marine Fisheries Service (NMFS) has relocated 21 adult male monk seals from the northwest Hawaiian Islands to the main Hawaiian Islands. There have been many recent sightings of monk seals in the main islands. However, while these seals may be found on beaches, they are not known to breed in these areas.

Populations of the endangered humpback whale (Megaptera novaeangliae) are known to winter in the Hawaiian Islands from December to April. Inner Waimanalo Bay, landward of the barrier reef, is consistently less than 20 feet in depth. Such shallow depths suggest that whales will seldom, if ever, venture into the inner bay.

CHARACTERISTICS OF THE DEVELOPED COMMUNITY ENVIRONMENT

Effective evaluation of wastewater management schemes must consider the characteristics and nature of the community and its residents. These include such aspects as the historical culture, local economy, demographics, land ownership and land use, population, public infrastructure and facilities, cultural resources, and quality of the community's environment (i.e. air quality and noise levels). The remainder of this chapter provides background information on these subject areas.

Historical Overview

The Waimanalo area is the site of one of the earliest settlements in Hawaii. Although the exact date is subject to debate by archaeologists, it is estimated that Waimanalo was settled some time between 800 and 900 A.D. Waimanalo was a traditional ahapua'a (land division) of approximately 7,000 acres, with natural boundaries formed by the Koolau Mountains to the south and southwest, and by the Anianinui Ridge and Keolu Hills to the north.

One of the most important events in the modern history of Waimanalo occurred on November 25, 1850, when Kamehameha III granted a 50-year lease to Thomas Cummins for 6,970 acres in Waimanalo. Cummins began a ranch for the breeding of cattle, race horses, and sheep. He married Kaumakaokane of the Liloa line, and their son John, who served as foreign minister in Kalakaua's government, succeeded his father as the lessee. Land records indicate that the Cummins family also obtained deeds and leases to 200 acres of kuleana lands in Waimanalo, complementing the earlier land leases.

Between 1877 and 1881, John Cummins converted the Waimanalo Ranch to the cultivation of sugar under the Waimanalo Sugar Company. In 1885, Waimanalo Sugar was acquired by Irwin & Company, which merged with C. Brewer & Company in 1910. Waimanalo Sugar continued its operations until December 4, 1942 and was liquidated by C. Brewer in 1947.

A renewable lease for 229 acres of federal land within the boundaries of the present Bellows Air Force Station was granted in 1923 by the War Department to the Waimanalo Sugar Company. After the war, the lease was reissued but terminated in 1958.

When Hawaii became a state in 1959, the Admission Act, Public Law 86-3, included provisions to determine the status of lands that had been ceded to or acquired by the federal government. In 1963 the Admissions Act was supplemented by another statute, Public Law 88-223, providing that any ceded land becoming surplus after a five-year period would also be conveyed to the State. Land identified at Bellows Air Force Station in the early 1960's was released to the state in 1966; additional land was identified as potentially excess by the Government Accounting Office in 1990.

The Hawaiian Homes Commission Act of 1920 directed that more than 200,000 acres of public land be made available for homesteading by persons of at least 50 percent Hawaiian ancestry. The State of Hawaii Department of Hawaiian Home Lands occupies much of the state owned land in Waimanalo. Currently, approximately 170 acres in Waimanalo are dedicated to Hawaiian Home Lands. The Department of

Hawaiian Home Lands has filed claims for additional excess lands at Bellows Air Force Station and on State lands presently zoned for agriculture.

Economic and Social Profile

The core of the Waimanalo planning area is a residential and agricultural community comprised of residential homes, small farm lots, community businesses, and parks and recreational facilities. Bellows Air Force Station is located adjacent to the "town" of Waimanalo.

Although Waimanalo is not a major economic center, a fair amount of employment opportunities exist within the area. The community based jobs, estimated at 1,500 in 1990 with no distinction between permanent full-time and temporary and/or part-time positions, are largely in the service industry (41 percent of the total).

Agriculture is the area's second most important industry, comprising 21 percent of the Waimanalo jobs in 1990. Major agricultural activities conducted in Waimanalo include dairy operations, nurseries and ornamental crops, tropical fruit orchards and truck crops. Implementation of the Waimanalo Agricultural Park project began in 1982 with the goal of ensuring that State owned lands zoned for agriculture would be cultivated through leases to qualified farmers. The agricultural park project encompasses approximately 196 acres. The Waimanalo Irrigation System, a State owned and operated system, serves agricultural water to approximately 1,150 acres of farmland. The irrigation system is a separate non-potable water system from the Board of Water Supply potable water system.

In general, commercial development is limited in Waimanalo. Sea Life Park, a significant visitor attraction on Oahu, is the major commercial activity located in the eastern end of the area. Olomana Golf Links is located on the western end of the study area. Various other Waimanalo businesses are primarily convenience-type stores and small scale commercial establishments which serve the needs of the local area residents. Most Waimanalo residents shop and conduct business activities outside the planning area, such as in Kailua-Kaneohe or Honolulu.

Statistics provided by the Hawaii State Department of Business and Industrial Relations show the average unemployment rate in the Waimanalo planning area for 1995 was 7.4 percent as compared with the islandwide rate of 4.6 percent.

Waimanalo's 1989 average household income of around \$49,000 was almost the same as the Oahu figure. However, because households are generally larger in Waimanalo, household incomes may result from a larger number of workers, each with lower average salaries. Per capita income in Waimanalo households in 1989 was about 75 percent of the island-wide figure. The proportion of Waimanalo households

receiving public assistance in 1990 (about 13 percent) was twice the island-wide rate. In addition, the 1990 poverty rates (percentage of persons with incomes below the federally defined poverty level) were higher in Waimanalo (9 percent), and particularly in Waimanalo town (11 percent), than island-wide (7 percent). There was a greater reliance on food stamps among Waimanalo residents (117.6 per 1,000 residents) than statewide (71.1 per 1,000). The Census figures also show that Waimanalo has a wider income distribution pattern, a larger gap between rich and poor, than the island as a whole.

In the 1990 census, approximately half of Waimanalo's population was identified as being of full or part Hawaiian ancestry, compared to 11 percent for Oahu as a whole. Many of those of with 50 percent or more Hawaiian ancestry reside within the approximately 640 Hawaiian Home Lands dwelling units. Lots are leased for 99 years at one dollar per year.

Other demographic information for the Waimanalo area contained in the 1990 census is as follows:

- Age: A larger proportion of Waimanalo's residents consisted of children under 18 (30 percent) than compared with the total Oahu population (24 percent).
- Education: Waimanalo's residents are less likely to have college degrees than other residents statewide: 16 percent as compared to 24 percent.
- Geographic mobility: Approximately 83 percent of Waimanalo's population was born in Hawaii, as compared to 54 percent of the population of the island as a whole. Waimanalo residents were much more likely to have been living in the same house five years previously than those elsewhere in the state.

Land Ownership

Most of the land ownership in Waimanalo can generally be divided into three major categories: Federal government, State government, and fee simple private ownership (U.S. Department of Agriculture, Soil Conservation Service, 1981). The State government is the largest landowner, with approximately 4,050 acres or two-thirds of the land. Portions of these State lands have been developed for housing by the DHHL, Office of Hawaiian Affairs, and the Hawaii Housing Authority. Other State lands have been leased to farmers under general leases or revocable permits. The Federal government owns 1,483 acres at Bellows Air Force Station. Land owned by the City and County of Honolulu is primarily limited to the road right-of-way. The remaining acreage is owned in fee simple by various individuals and other entities.

The 10.1 acre Waimanalo WWTP site (TMK 4-1-09:270) is owned by the State of Hawaii but is under the jurisdiction of the City and County of Honolulu under an Executive Order. The 0.032 acre site of the Kahawai Stream Wastewater Pump Station (TMK 4-1-15:16) is owned by the State of Hawaii.

Population and Projected Growth

1. General

Waimanalo's population, including projections of future development and anticipated population growth within the sewer service areas, is discussed below. Land use policies and controls, which have significant impact on population growth and distribution, are discussed in the next chapter.

Projection of future development and population growth is often a difficult and subjective task due to the many variables involved. Rational service population estimates, however, are required to generate projected wastewater flows and allow for sound planning of future wastewater facility infrastructure. The consequences of underestimating the service population and wastewater flows include wastewater spills, facility performance and operational problems, and development delays and constraints. Overestimating population and wastewater flows, on the other hand, may result in unnecessary expenditure of limited financial resources.

The following general methodology was employed in the Waimanalo Wastewater Facilities Plan to evaluate the existing population and develop future sewer service area population estimates:

- The number of housing units in the various development areas were first estimated. This provided baseline information on the number of: 1) homes that are currently on sewers, 2) homes in areas that may potentially be sewered, and 3) homes in unsewered areas that are not intended to be sewered.
- The existing population was then distributed among the various development areas based on estimated household sizes for sewered and unsewered areas.
- The future sewered population was estimated based on identification of future developments and developable areas, and projected changes in household size.

Population projections and housing densities were based primarily on the following sources of information:

- Traffic Analysis Zone (TAZ) population and employment data and projections from the City and County of Honolulu Planning Department of Planning for 1990 (census), 1995 and 2020.
- Information on planned future developments by the State of Hawaii Department of Hawaiian Homes Lands (DHHL), Office of Hawaiian Affairs (OHA), State of Hawaii Department of Land and Natural Resources (DLNR), Bellows Air Force Station (AFS), Hawaii Housing Authority (HHA), Housing Finance Development Corporation (HFDC), and various other entities involved in development in Waimanalo.
- Existing Land Use Map from the City Department of Planning and Permitting (DPP), December 1988, updated by Hawaii Pacific Engineers with additional available DPP information (as of June, 1992) and other miscellaneous sources of data on individual developments.
- Data on household size from a cesspool/septic tank survey conducted by Hawaii Pacific Engineers in July, 1996 (see discussions in Chapter 5).

Census information and other data provided by the City DPP are based on Census Tract 113, which is identical to the Waimanalo planning area used in this study. For the purposes of this study, the small number of persons living in Bellows AFS and the Sea Life Park area in Makapuu are considered insignificant and were not included in the planning area population analyses.

2. Existing Population

The Waimanalo planning area residential population was 9,055 based on the 1990 census. The area's 1997 population is estimated to be approximately 9,400 based on the TAZ population estimates provided by the City's DPP.

The current estimated residential population of 9,400 is lower than the 10,600 residential population for 1995 projected by the 1984 Facility Plan (Wilson Okamoto, 1984). The previous facilities plan based population projection on the now outdated 208 Water Quality Management Plan for the City and County of Honolulu (DOH, 1980). The 208 plan projections were based on the Series II-F projections (dated March 1978) developed by the State Department of Planning and Economic Development. The current policy of the City and County of Honolulu Department of Design and Construction is to utilize the TAZ population projections for its planning studies.

It is estimated that approximately 6,130 residents, or about 65 percent of the total, currently reside in areas serviced by the wastewater collection system. The remaining residents live in areas without sewers and must rely on individual wastewater systems.

3. Existing Wastewater Service Areas, Housing Units and Population Distribution

Existing developed areas in Waimanalo, with sewered and unsewered areas differentiated, are shown on Figure 3-11. The unsewered agricultural lots, which are scattered throughout the mauka area of the service area, are not specifically identified on the figure but were included in this study's population analysis. The private beach lot homes (Sewer Improvement District Sections 2 and 3) and the unsewered DHHL homes in the Bell Street area (Sewer Improvement District Section 5) are currently unsewered areas that have been previously targeted for installation of sewers by the City and the 1984 Facility Plan.

The estimated existing housing units, population, and household sizes in sewered and unsewered developments are presented in Table 3-8. An average household size of 4.5 persons for government sponsored single family housing category was estimated based on attaining a reasonable distribution of population among the various areas and an analysis of wastewater flow data for sewered areas. This category of housing represented the majority of the existing sewered residences. The overall average household size of 4.0 is consistent with the 1995 TAZ projections.

4. Projected Future Population and Proposed Future Developments

There are a number of methods and sources of population projections that may be employed in planning studies. Population projections may be based on historical trends, land use projections, economic factors, demographics, and other variables. Population projections have been developed by both City and State planning departments. Population projections for the Waimanalo Wastewater Facilities Plan are based primarily on consideration of land use/development projections and the City's TAZ population projections. Population projections developed by the State were also briefly examined for comparison purposes.

a. City Traffic Analysis Zone (TAZ) Population Projections

The City Department of Design and Construction and its consultants have previously utilized various population projections, land use projections and models, and criteria from its Design Standards for facility planning purposes. The current policy is to utilize the City's Traffic Analysis Zone (TAZ) population projections as the primary basis for facility planning. This policy

DATE: 09/09/98 MS
 SCALE: 1" = 2000' OPER: SHI/CDK
 FILE: 9524-12A REVISED: 4/20/98



GRAPHIC SCALE:
 1000' 500' 0 1000' 2000'
 SCALE: 1" = 2000'

HPE Hawaii Pacific Engineers, Inc.
 CONSULTING ENGINEERS

WAIMANALO WASTEWATER
 FACILITIES PLAN

EXISTING SEWERED AND
 UNSEWERED DEVELOPMENTS

FIGURE 3-11

- LEGEND**
- XXX (XXX) NAME (OR TYPE) OF DEVELOPMENT OR SEWER IMPROVEMENT DISTRICT (HOUSING DEVELOPER)
 - [Hatched Box] EXISTING SEWERED RESIDENTIAL AREAS
 - [Dotted Box] EXISTING SEWERED NON-RESIDENTIAL AREAS
 - [Cross-hatched Box] EXISTING UNSEWERED RESIDENTIAL AREAS PROPOSED FOR SEWERING
 - [Diagonal Lines] EXISTING UNSEWERED NON-RESIDENTIAL AREAS PROPOSED FOR SEWERING

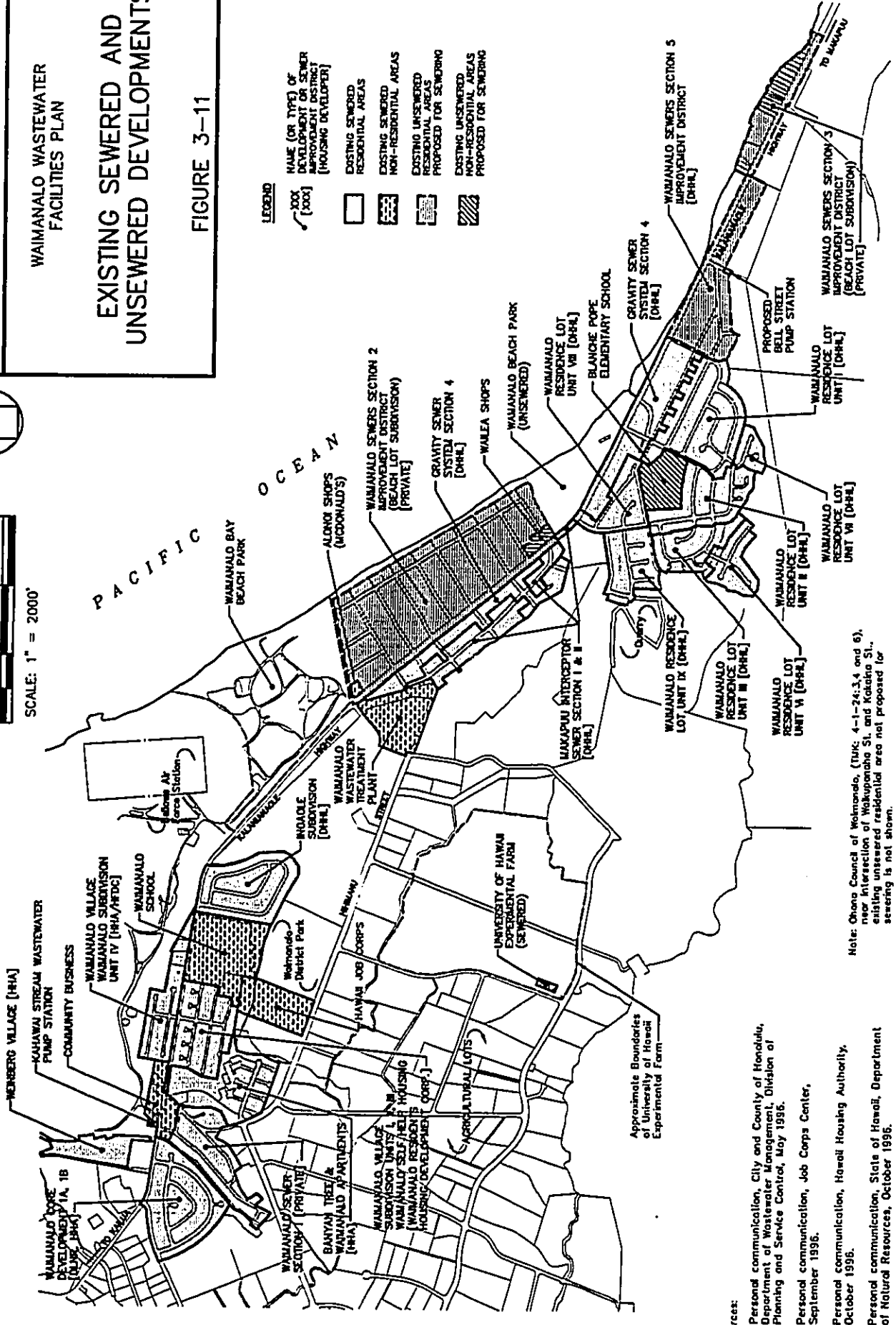

Note: Ohana Council of Waimanalo, (TRK: 4-1-24; 3, 4 and 6), near intersection of Waiupanaha St. and Kakaia St., existing unsewered residential area not proposed for sewerage is not shown.

- Sources:
1. Personal communication, City and County of Honolulu, Department of Wastewater Management, Division of Planning and Service Control, May 1996.
 2. Personal communication, Job Corps Center, September 1996.
 3. Personal communication, Hawaii Housing Authority, October 1996.
 4. Personal communication, State of Hawaii, Department of Natural Resources, October 1996.
 5. Waimanalo Agricultural Park, Phase I Increment Environmental Impact Statement, March 1982.

Approximate Boundaries of University of Hawaii Experimental Farm

**TABLE 3-8
ESTIMATED EXISTING POPULATION AND HOUSEHOLD SIZE**

Development Type	Estimated Existing Population	Estimated No. of Housing Units ¹			Estimated Household Size (capita/unit)
		Sewered Area	Unsewered Area	Total	
Single family homes primarily developed by DHHL and other government agencies	5,850 ¹	1,210	90	1,300	4.5 ²
Townhouse and apartment units	690 ³	230	0	230	3.0
Single family homes on private beach area lots	1,440	0	380	380	3.8 ⁴
Single family homes on private agricultural lots	1,420 ⁵	0	425	425	3.3
Total (all areas)	9,400⁶	1,440	895	2,335	4.0

Notes:

1. Based on housing counts from DLU Existing Land Use Maps, December 1992, updated by Hawaii Pacific Engineers, Inc. with June 1992 data provided by DLU and other supplemental data. It excludes housing at Ohana Council of Waimanalo (Nation of Hawaii) and small number of housing units at Bellows AFS and other outlying areas.
2. Estimated density derived from the difference between total population and estimated population of other areas, and evaluation of wastewater flow monitoring data.
3. Based on available resident population data (150 residents at Kau Hale Ohana, 12 residents at Banyan Tree Model complex, and 202 residents at Waimanalo Apartments) and estimated density of 2.7 persons/unit at Banyan Tree townhouses.
4. Based on 150 responses to mail-out cesspool/septic tank survey of area (40 percent responded to survey).
5. Based on difference between total population and estimated population of other areas, and estimates of a reasonable household size. The 208 Plan (C&C of Honolulu, 1990) reported a "non-service area" (i.e., agricultural lots) population count of 1,409 in 1980.
- 6.. Based on 1995 DLU Traffic Analysis Zone (TAZ) resident population data. Excludes Ohana Council of Waimanalo (Nation of Hawaii) population of approximately 100 persons.

is intended to provide a more uniform basis of planning for the various areas and among various City agencies and consultants.

The TAZ population projections and the 1990 census population for the Waimanalo planning area (Census tract 113) are shown on Table 3-9. Discussions with the City Department of Planning (Young, 1996) provided valuable insight on the TAZ population projections. Some of the key points are as follows:

- The TAZ populations are "middle of the road" best estimates developed based on available information. It would be prudent to base the design of major infrastructure on population projections that are more conservatively estimated than the TAZ projections.
- For the Waimanalo area, the TAZ projections do not include consideration of possible growth resulting from DHHL developing existing Bellows AFS land. The City projections for Waimanalo are relatively low since historically DHHL has not implemented their development projects in a timely manner.
- Population does not necessarily increase in proportion to the number of housing units. As more homes are constructed in an established community with large households (extended families), the tendency is for a substantial proportion of the existing residents to move into the new units.

TAZ employment population projections were also provided by the City Department of Planning. These employment projections, however, were not used directly. It was concluded that the number of employees (jobs) does not in many cases reflect the wastewater generation potential. Non-employment flows such as those from schools, job training centers, and parks in Waimanalo would be difficult to quantify based on use of employment figures alone. It was determined that reasonably accurate estimates of wastewater generation rates could be developed for non-residential areas based on land use information and supplemental data for specific entities. This methodology was well suited for Waimanalo due to the relatively small number of commercial, industrial and other non-residential activities in the planning area.

b. State "M-K" Series Projections

The "M-K" Series population projections for the period from 1985 to 2010 were officially adopted by the State of Hawaii Department of Business and

**TABLE 3-9
TRAFFIC ANALYSIS ZONE (TAZ) PROJECTIONS**

Year	Residential Population	Employment Population	Housing Units
1990*	9,055	1,514	2,204
1995	9,397	1,468	2,345
2000	9,487	1,429	2,391
2005	9,583	1,487	2,494
2010	9,820	1,523	2,601
2015	9,920	1,550	2,680
2020	10,071	1,629	2,747

*Based on 1990 census data.

Source: Traffic Analysis Zone (TAZ) data from City and County of Honolulu of Planning Department.

Economic Development in November 1988. These population projections were utilized in the preparation of the updated 1990 Water Quality Management Plan for the City and County of Honolulu, also known as the "208 Plan."

Based on the 208 Plan's allocation of the M-K Series population projections within the plan's Waimanalo Subdistrict³ boundaries, the population of Waimanalo was stated as being 9,120 in 1985 and projected to increase to 9,300 by the year 2010. The M-K Series population figures are somewhat lower than the TAZ projections. In comparison, the 1995 TAZ estimated population is 9,397 and the estimated 2010 TAZ population is 9,820.

5. Assessment of Future Land Use and Development

As part of Waimanalo Facilities Plan study, proposed developments by various agencies and entities were investigated. The locations of the proposed future developments to be sewered are shown on Figure 3-12.

The following discussion presents a brief summary of projected developments identified or assumed in this study.

a. Department of Hawaiian Homelands (DHHL)

(1) General

The mandate of the State of Hawaii Department of Hawaiian Home Lands (DHHL) is to provide homestead housing for those with at least 50 percent Hawaiian ancestry. DHHL is a part of the executive branch of the Hawaii State government. In Waimanalo, projects by the (DHHL) will continue to have a much more significant impact on future land use than any other single factor.

Three future DHHL projects that are envisioned for the Waimanalo planning area within the next twenty years are shown on Figure 3-12 and summarized on Table 3-10. The Waimanalo Residence Lot Unit IX project also shown on Figure 3-12 was recently completed. This project has 53 parcels and is eventually expected to house approximately 210 additional residents.

³The Waimanalo Subdistrict is defined by the 208 Plan as extending from Wailea Point (Bellows AFS) to Makapuu Point and from the shoreline to the Forest Reserve. The boundaries are similar to those used in this study.

DATE: 09/03/90 MS
 SCALE: 1" = 2000' OPER: SHA, CDK, FA
 FILE: 9524-13A REVISED: 4/16/98



GRAPHIC SCALE:
 1000' 500' 0 1000' 2000'
 SCALE: 1" = 2000'

HPI Hawaii Pacific Engineers, Inc.
 CONSULTING ENGINEERS

WAIMANALO WASTEWATER
 FACILITIES PLAN

PROPOSED FUTURE AND EXISTING DEVELOPMENTS TO BE SEWERED

FIGURE 3-12

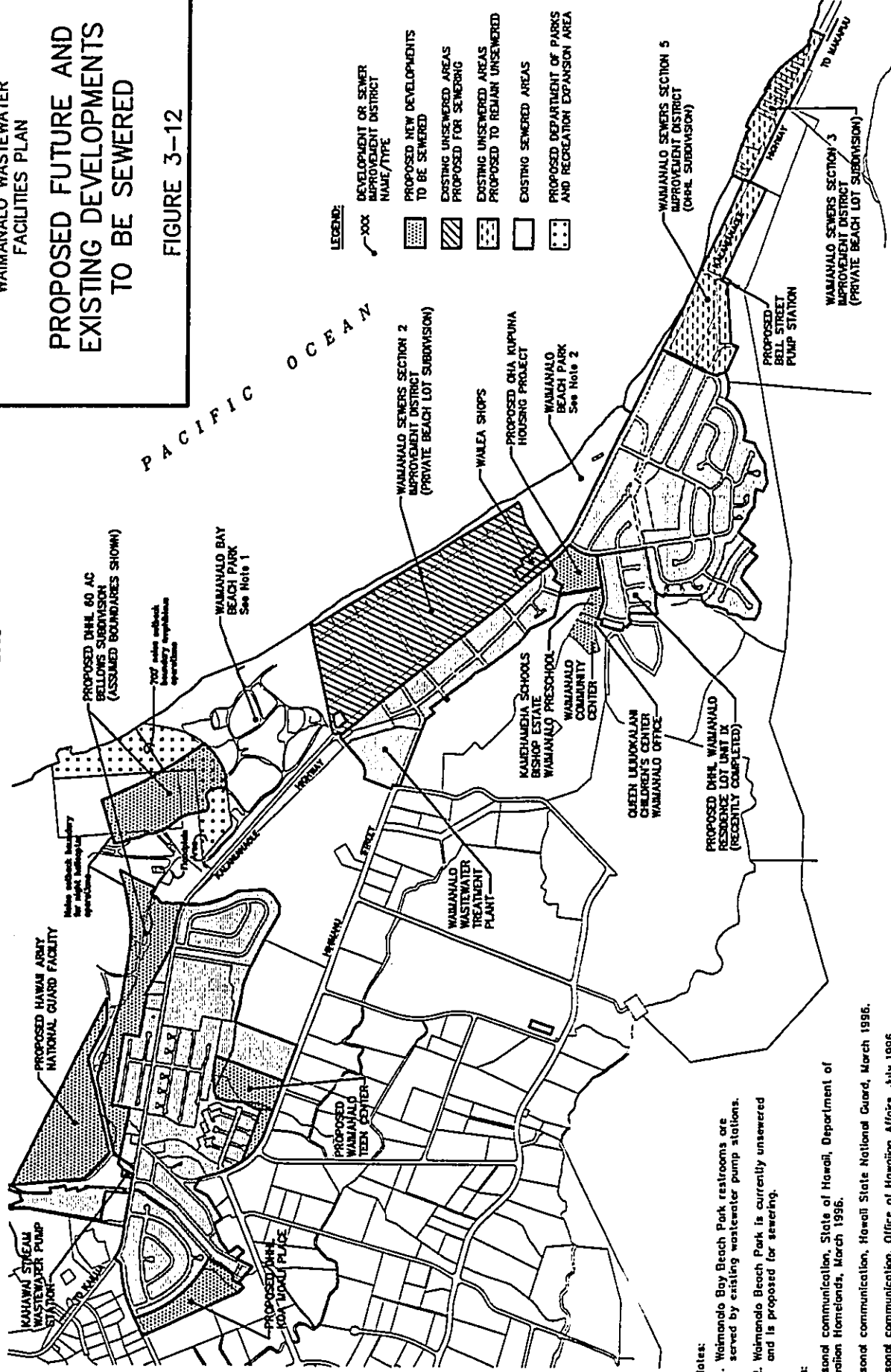

- Notes:
1. Waimanalo Bay Beach Park restrooms are served by existing wastewater pump stations.
 2. Waimanalo Beach Park is currently unsewered and is proposed for sewerage.

- Sources:
1. Personal communication, State of Hawaii, Department of Hawaiian Homelands, March 1996.
 2. Personal communication, Hawaii State National Guard, March 1996.
 3. Personal communication, Office of Hawaiian Affairs, July 1996.
 4. Personal communication, Engineering Solutions, Inc., September 1996.
 5. Personal communication, City Department of Parks and Recreation, December 1996.

**TABLE 3-10
FUTURE DEPARTMENT OF HAWAIIAN HOME LANDS DEVELOPMENTS**

Development Name	Projected Start Date	Number of Units	Type of Unit ¹	Ultimate Population
Koa Moali Place	1999	75	SF	300
Makapuu Vista ²	2005	60	MF (Townhouse)	240
Bellows Subdivision ^{2,3}	2010	416	SF	1,664
Total	-	551	-	2,204

Notes:

1. SF and MF are single family and multi-family, respectively
2. Development dates for Makapuu Vista and Bellows Subdivision are assumed early start dates. DHHL has not scheduled these developments.
3. The initial phase of the DHHL Bellows Subdivision project is estimated to encompass approximately 60 acres of readily accessible and developable land. An allowance of 20 percent of the area for streets, parks, utilities, etc. is assumed. It is assumed that the initial phase of the development will be completed by year 2020.

Of the three projects, the Makapuu Vista development is the only project that is outside of the sewer service area. This project is located approximately one mile from the east end of the existing sewer system. DHHL indicated that it intends to service the Makapuu Vista development utilizing individual wastewater systems.

It is estimated that the four proposed DHHL projects and the recently completed Waimanalo Residence Unit IX project could potentially increase the population of Waimanalo by approximately 2,420 residents by the year 2020. By the year 2000, approximately 510 additional residents associated with DHHL developments could potentially be added to the sewer service population. The Bellows subdivision project, estimated to be approximately 60 acres in size by the Waimanalo Facilities Plan, is projected to result in an additional 1,660 customers by the year 2020.

DHHL projects, particularly the Koa Moali Place project, may be affected by the inability of the existing Waimanalo WWTP to accept additional flow. The timing of DHHL projects is also uncertain due to DHHL's budget limitations and other factors. In general, the start dates presented are somewhat optimistic, but deemed appropriately conservative from a facility planning perspective.

(2) Development of Excess Bellows AFS Land

The project to develop declared excess land at Bellows AFS, referred to in this report as the DHHL Bellows subdivision, would be the largest future DHHL project. According to the Final Environmental Impact Statement and Land Use and Development Plan, Bellows Air Force Station (Belt Collins Hawaii, 1995a), 170 acres of the Bellows AFS land have been designated as excess. DHHL has the rights to this land but regards portions of the land as not suitable for residential housing. These unsuitable areas include land exposed to excessive noise from nearby military activities and land within the floodway of Inoaole Stream.

DHHL has made preliminary contact with the City Department of Parks and Recreation Services regarding a potential swap of beachfront Bellows AFS land (unsuitable for residential development but suitable for park facilities) with land at the Waimanalo Bay Beach Park. The response received to date from the Department of Parks and Recreation Services has been unfavorable.

Current DHHL plans call for developing residential housing on the excess Bellows AFS land subject to the applicable land use constraints. The constraints that limit use of the land for residential development include noise buffer zones for military aircraft landings and amphibious military exercises, and the 100-year floodway of Inoaole Stream.

The proposed housing site will be constrained to the north by the Ldn 55 noise level contour for nighttime military helicopter exercises at Bellows AFS.⁴ The site will be constrained on the makai side by the Ldn 55 noise level for nighttime amphibious practice landings along the shore. Ldn 55 was designated as the significant nighttime impact threshold for housing in the Bellows AFS environmental impact statement.

Development of residential housing within the boundaries of the 100-year flood plain of Inoaole Stream is not anticipated to be feasible (see Figure 3-18 in later discussions). In addition to flood hazards, the flood plain may also contain archaeological sites.

Based on the above constraints, approximately 60 acres of land was estimated in the Waimanalo Facilities Plan to be available for DHHL housing development. The proposed Bellows Subdivision is envisioned to be bisected by the floodway into two parcels approximately 30 acres each in size.

Environmental factors associated with hazardous materials are not anticipated to have a major impact on the development of the DHHL Bellows subdivision. A portion of the land is within a former Nike/Hercules Missile Launch Site. The U.S. Air Force conducted a site investigation and concluded that contamination by hazardous materials is not a significant problem at the site (U.S. Air Force, 1997). The U.S. Department of the Interior must ultimately approve the transfer of federal land to the state.

The City Department of Parks and Recreation Services is also interested in acquiring a portion of the designated excess lands at Bellows AFS (City and County of Honolulu, Department of Parks and Recreation, 1996b). The park expansion area currently envisioned by the City

⁴Ldn is defined as the day-night sound level, which can be computed from the equivalent sound level or modeled to depict the daily noise levels experienced from a specific pattern of aviation operations at a given location.

conflicts with a portion of the eastern DHHL parcel (see Figure 3-12). The priority of claims on the excess land and process for adjudicating conflicting claims are not clear at this time. The City, however, is most interested in acquiring the shoreline area of the excess lands due to the recreational value of these areas. Acquisition of the shoreline area by the City would not conflict with the proposed DHHL Bellows subdivision.

Due to the above constraints, implementation of the proposed 60 acre DHHL Bellows subdivision project is anticipated to be a lengthy process. DHHL planners generally concur that development of the full 170 acres of excess Bellows AFS land would not be viable. The planners indicated that the development of a smaller area, such as the 60-acre parcel proposed by this study, is also uncertain. For the wastewater facility planning purposes of this study, development of the 60-acre parcel by DHHL was included to arrive at a conservative yet plausible planning scenario. Including the development in the population projections provides a reasonable degree of "cushion" in the planning estimates.

b. Office of Hawaiian Affairs

The mandate of the Office of Hawaiian Affairs (OHA) is to serve as an advocate for those of Hawaiian ancestry. OHA has interpreted its mandate to include installation of various kinds of human services, including development of living quarters. From a governmental perspective, OHA is independent from other governmental bodies, with a separately elected commission.

OHA proposes to construct a multifamily development in Waimanalo for elderly persons of Hawaiian descent in cooperation with DHHL (OHA, DHHL, 1998). The proposed Kupuna Elderly Housing project includes 84 apartment units. The estimated service population is 126 persons based on an assumed average of 1.5 occupants per unit. The project is also proposed to include a commercial complex with approximately 10,000 square feet of gross leasable area. Construction of the project, which was expected to begin in fall of 1998, may be affected by the ability of the Waimanalo WWTP to accept additional flow. At the time of this DSEIS preparation, the use of a temporary septic tank system for 33 of the 84 residential units and the commercial complex was denied by DOH (R.M. Towill, 1998).

c. Ohana Council of Waimanalo

The Ohana Council of Waimanalo (Nation of Hawaii) has occupied a portion of the agricultural land in Waimanalo. For the purposes of this study, it was assumed that substantial growth of this development beyond the existing population of about 100 residents will not occur. This development is not expected to have a direct impact on the Waimanalo WWTP since DLNR indicated that the intent is to service the development utilizing individual wastewater treatment systems.

d. Bellows Air Force Station

According to the final environmental impact statement for Bellows AFS (Belt Collins Hawaii, 1995a), the preferred development alternative does not include future military residential housing at the site. Two sites for up to 500 military family housing units were considered during the planning process but were not included in the preferred alternative. The U.S. Marines currently utilize the Bellows AFS for much of its training activities and is expected to continue to do so in the future. There are plans to transfer responsibility for most of the non-excess land at the Bellows AFS to the Marine Corps Base Hawaii in the future.

The preferred alternative described in the Bellows AFS EIS includes a project for a Hawaii Army National Guard (HIARNG) training site on about 33 acres of land. About 11 acres of this land would be devoted to administration/training and dormitory facilities. The remainder of the HIARNG site would be used for recreational and training facilities. The installation is anticipated to house up to 40 people during weekend and other training periods. The facility is scheduled to be constructed by year 2000 and is proposed to be connected to the City sewer system.

e. Agricultural Areas of the Waimanalo Irrigation System Project

The Waimanalo Irrigation System project, which was implemented starting in 1982, encompasses approximately 1,900 acres. The project complemented a related project, the Waimanalo Watershed Project, which provided improvements to irrigation facilities serving 1,252 acres in Waimanalo. The Irrigation System's primary developing and funding agency was the U.S. Department of Agriculture, Soil Conservation Service (now known as the Natural Resources Conservation Service). Supporting agencies included the State Department of Land and Natural Resources and the State Department of Agriculture. The Irrigation System has been completed with the exception

of a proposed infrastructure to utilize treated wastewater effluent for irrigation.

The population within the agricultural lots is not anticipated to increase substantially in the future. The 208 Plan (C&C of Honolulu, 1990) actually projected a decrease in population from 1,400 in 1985 to 1,200 in 1995, and to 900 in 2010, within the "non-service areas" (i.e., agricultural lots).

The agricultural lots in Waimanalo are intended to continue to be served by individual wastewater systems.

f. Other Developments and Proposed Wastewater Connections

The Waimanalo Teen Center is proposed to be constructed adjacent to the existing Hawaii Job Corps development and will share the Job Corps private wastewater pump station and force main. The Teen Center day population is estimated to be 223 persons (Engineering Solutions, 1996).

Three *projects* are proposed to be implemented on DHHL land located adjacent to the previously discussed Kupuna Housing project. These projects are the Waimanalo Community Center being developed by the Waimanalo Hawaiian Homes Association, the Queen Liliuokalani Children's Center Waimanalo Office, and the Waimanalo Preschool being developed by Kamehameha Schools Bernice Pauahi Bishop Estate. The equivalent resident service population for these three projects on a total of 4.8 acres of land is estimated to be 50 persons. The community center is expected to be used for gatherings of up to 300 persons primarily on weekends and holidays. The Children's Center Office is expected to have five workers. The preschool is expected to have 80 students and 10 staff members. The construction of the preschool project is expected to be completed in Fall 1999 if wastewater capacity and sewer connection issues are resolved.

The existing Pope Elementary School and the Waimanalo Community Beach Park are projected to be connected to the sewer system in the future. Pope Elementary School has a projected future student and faculty population of 384 based on proportionate increases in the area's population. The Waimanalo Community Beach Park is conservatively estimated to have a visitor load of 1,300 per day.

For planning purposes, currently vacant parcels in areas serviced by sewers are assumed to be developed in the future. This study estimated that there are 19 vacant parcels.

6. Projected Future Population

The projected year 2020 residential and non-residential populations in existing and proposed sewer service areas are summarized in Table 3-11. The projected year 2020 total residential sewer service area population is 9,284 and the projected overall total "equivalent" service area population is 10,767. The term equivalent population refers to the "equivalent" residential population (number of residents) that would generate a comparable wastewater flow as the specified non-residential entity actually generating the flow.

The beach lot area (Sewer Improvement District No. 2) was determined by this study to be the only existing major unsewered area that may require sewerage in the future due to water quality concerns (see discussions in Chapter 5). The DHHL housing and private beach lots in the vicinity of Bell Street (Sewer Improvement District Nos. 3 and 5) are not recommended for sewerage based on the evaluation of alternatives (see discussions in Chapter 2). The Bell Street area is very costly to sewer due to the need for a new wastewater pumping station and the relatively small number of homes. The water quality benefits of eliminating the relatively small number of individual wastewater systems are not anticipated to be significant. The locations of the three sewer improvement districts were shown previously on Figure 3-12.

Based on no growth within the unsewered agricultural lot area and development of the unsewered DHHL Makapuu Vista housing area, the projected year 2020 total resident population is 11,370.⁵ This exceeds the year 2020 TAZ population projection of 10,071 by approximately 13 percent. Since the TAZ population projections are considered "middle of the road" projections, the slightly conservative projections utilized in this study for major wastewater infrastructure planning are considered appropriate.

The projected household size for single family dwellings in sewer service areas is projected to decrease from 4.5 persons in 1995 to 4.0 persons in year 2020. As previously noted, the population in areas with high household densities are not expected to increase in proportion to the number of housing units because a substantial number of existing residents within the community are expected to move into many of the new homes. The projected average future family household size of 4.0 persons for single family homes is considered to be

⁵The estimated total resident population is comprised of the following projected residents: 9,312 residents on sewers (see Table 3-11) and 2,056 residents on individual wastewater systems (396 Sewer Improvement Districts 3 and 5 residents, 240 Makapuu Vista residents, and 1,420 agricultural lot residents).

**TABLE 3-11
PROJECTED YEAR 2020 POPULATIONS FOR SEWER SERVICE AREAS**

Development	Estimated Equivalent Population ¹			Estimated No. of Housing Units
	Existing Sewered Areas	Additional Future Areas to be Sewered	Total For All Areas	
RESIDENTIAL				
Existing lots primarily developed by DHHH/other government agencies (single family units) ^{2, 3}	5,140	0	5,140	1,285
Townhouses and apartments	693	126	816	315
Existing private beach lots ⁴	0	1,392	1,392	348
New DHHH Bellows subdivision ²	0	1,664	1,664	416
Other new DHHH subdivisions ⁵	<u>0</u>	<u>300</u>	<u>300</u>	<u>75</u>
Subtotal	5,833	3,482	9,312	2,439
NON-RESIDENTIAL				
Shopping/Commercial/Misc. Areas ⁵	343	84	427	--
UH Experimental Farm	45	0	45	--
Hawaii Job Corps	263	0	263	--
Schools ⁶	268	120	388	--
Hawaii Army National Guard	0	40	40	--
Waimanalo Teen Center	0	70	70	--
Beach Park Recreation Areas	<u>88</u>	<u>162</u>	<u>250</u>	--
Subtotal	1,007	476	1,483	--
TOTAL RESIDENTIAL AND NON-RESIDENTIAL	6,840	3,958	10,795	2,439

Notes:

1. Equivalent population refers to the "equivalent" residential population that would generate a comparable wastewater flow as the specified entity actually generating the flow.
2. Based on projected year 2020 average sewered residential population density of 4.0 persons per dwelling unit.
3. Excludes Waimanalo Sewers Section 5 Improvement District. It is recommended that the Section 5 Improvement District remain on individual wastewater systems. This area has an estimated 65 housing units and a projected future population of 260.
4. Consists of Waimanalo Sewers Section 2 Improvement District. Excludes Waimanalo Sewers Section 3 Improvement District. It is recommended that the Section 3 Improvement District remain on individual wastewater systems. This area has an estimated 34 housing units and a projected future population of 136.
5. Miscellaneous area includes the fire station and a church.
6. Equivalent population for public schools based on anticipated increase in enrolment consistent with percentage increase in overall population.

appropriate since the large number of DHHL and other government developed homes serviced by the sewer system tend to have large households. The 4.0 person household size is also consistent with the City's Design Standards for single family residences.

Based on consideration of all dwelling units (single family and multi-family), the average household size is projected to be 3.75 persons based on a total of 3,032 housing units in the year 2020. This household size is slightly more conservative than the 3.67 person household size computed for the TAZ year 2020 projections. The TAZ projections estimates approximately 290 fewer dwelling units in the year 2020.

7. Projected Wastewater Flows

Based on projected year 2020 wastewater service populations, the Waimanalo Wastewater Facilities Plan developed projected design wastewater flows for the proposed expansion of the Waimanalo WWTP.

An average design wastewater flow of 1.1 million gallons per day (mgd) was derived based on the projected year 2020 equivalent service population of 10,800 persons. The average design flow was based on a unit wastewater generation rate of 80 gallons per capita per day (gpcd) for the existing population and 72 gpcd for the future population. A lower generation rate was utilized for the future population due to the anticipated use of low volume water closets and other water saving devices. A dry weather infiltration allowance of 0.26 mgd was developed based on evaluation of existing flow monitoring data.

A year 2020 design peak flow of 4.8 mgd is proposed for the expanded Waimanalo WWTP based on analysis of wet weather infiltration and inflow information from the City's ongoing sewer assessment studies (Fukunaga and Associates, 1995). The proposed rehabilitation of sewers is projected to reduce future inflow of rainwater into the sewer system by approximately 2.0 mgd (from 5.0 mgd to 3.0 mgd) for a storm with a 5-year recurrence interval.

Water Supply

Potable water for the Waimanalo planning area is provided by the City and County of Honolulu Board of Water Supply (BWS) water system. Non-potable irrigation water is supplied by the State-operated Waimanalo Irrigation System.

1. Domestic System

The BWS potable water system consists of a system of tunnels, wells, storage tanks and reservoirs, pumps, water mains, and fire hydrants. The system was originally designed to supply water for domestic use. However, it is also currently being used for irrigation purposes by approximately 44 farm lots. BWS requires landowners to bear the cost of upgrading non-BWS transmission and distribution facilities where connections to the system are allowed. BWS personnel indicated that sources and storage systems are deemed sufficient for anticipated growth in the Waimanalo area, but the farm lot distribution system needs to be replaced to achieve adequate pressures for domestic use and fire protection.

The existing potable water system supply consists of two deep water wells, Waimanalo Well I and II (DLNR #2043-02 and #1943-01 respectively), and four high level tunnels in the Waimanalo planning area (see Figure 3-8). The combined capacity of these sources is approximately 1.7 million gallons per day (Board of Water Supply, 1996). The BWS intends to install pumping facilities at the new Waimanalo Well No. 3 to supply an additional 0.5 million gallon per day in the future.

The Waimanalo Well I (see Figure 3-8) is currently inactive due to detected contamination from a herbicide known as alachlor. BWS personnel indicated that the nitrate concentrations in the inactive well were fairly high. Limited sampling by BWS indicated nitrate concentrations in the well were near the 10 mg/L potable water maximum contaminant level of the Safe Drinking Water Act. It is unknown whether the high nitrate concentration in the inactive well is due to the use of cesspools and/or fertilizers in the nearby surrounding agricultural lots.

2. Waimanalo Irrigation System

The Waimanalo Irrigation System (see Figure 3-8) was originally installed by the Waimanalo Sugar Company to convey water from Maunawili Valley to Waimanalo. Water is collected from stream flows and springs by the Maunawili Ditch and transported by a tunnel through Aniani Nui Ridge. The irrigation water transmission system to the Kailua Reservoir consists of tunnels and pipelines. The irrigation water distribution system from the Kailua Reservoir consists of pipelines and ditches. The Waimanalo Irrigation system provides the farmers with 75 million gallons annually.

The Waimanalo Agricultural Park, administered by the State of Hawaii Department of Agriculture, consists of approximately 134 farmers on about 1,000 acres of land. Phase I of the Waimanalo Agricultural Park project was initiated in 1982.

This phase resulted in improvements that replaced the original ditch system with a piped system and additional reservoirs. The only component of the Phase I Waimanalo Agricultural Park that has not been installed is a proposed project to supply treated Waimanalo WWTP effluent for irrigation use. The proposed Phase II of the Waimanalo Agricultural Park was not implemented.

Wastewater Facilities

Approximately 65 percent of Waimanalo's population reside in areas serviced by the Waimanalo wastewater collection and treatment system. The remainder of the areas are serviced by individual wastewater systems such as cesspools and septic tanks. The wastewater collection and treatment system is comprised of over 50,000 feet of gravity sewers, the Kahawai Stream Wastewater Pump Station and force main, and the Waimanalo WWTP.

The wastewater facilities are the focus of the Waimanalo Wastewater Facilities Plan. The proposed improvements to the facilities are discussed in Chapters 1 and 2 of this document. The following discussion provides background information on the existing facilities.

1. Wastewater Collection System

Waimanalo's regional wastewater collection system is comprised of a network of gravity sewers and the Kahawai Stream Wastewater Pump Station (WWPS) and force main. Much of the Waimanalo wastewater collection facilities, including the wastewater pump station, was constructed by DLNR and is owned by the State of Hawaii. The Department of Hawaiian Homes (DHHL) constructed sewers within the newer DHHL subdivisions and has retained ownership of the lines. Under an agreement with the State, the operation and maintenance of the sewers and pump station facilities constructed by DLNR is performed by the City and County of Honolulu. The City also assists DHHL with maintenance of sewers owned by DHHL. The City owns and operates some of the sewer lines located on the east side of the Waimanalo WWTP that were constructed by the City. The general configuration of the collection system was shown previously on Figures 1-2a and 1-2b.

The Kahawai Stream WWPS and force main was constructed in 1969. Construction of the Waimanalo gravity collection system began in 1971 and the system has continued to expand largely with the construction of additional State housing developments. The existing gravity collection system consists of a network of sewer lines ranging from 6-inch to 24-inch diameter pipelines on the east and west sides of the Waimanalo WWTP.

The sewer trunk lines in the Waimanalo collection system were inspected in May 1996 by means of a dolly-mounted video camera. This work was performed as part of the sewer system evaluation survey (SSES) field investigation for a sewer rehabilitation and infiltration inflow study (Fukunaga & Associates, 1995). The video inspection showed that the trunk lines are in relatively good condition. Although the majority of the trunk sewers are below the water table, no major sources of dry weather infiltration were found during the inspection. The remainder of the collection system (lines other than the main trunk lines) was not inspected by camera, therefore, currently there is no visual evidence regarding the integrity of the smaller diameter sewers.

Wet weather infiltration and inflow (WWI/I) appears to be generated primarily on the west side of the collection system. Flow monitoring data indicates that the majority of the WWI/I is occurring upstream of the Kahawai WWPS. The tributary area for this portion of the collection system is approximately 142 acres. Based on review of flow monitoring data provided by Fukunaga & Associates, the rapid increase in flows in response to rainfall would tend to indicate that the WWI/I is due primarily to inflow rather than subsurface infiltration. The muddy appearance of the wastewater flow observed in the field during storm conditions would further indicate that the inflow stems from surface runoff as opposed to illicit roof gutter connections.

The hydraulic capacities of the collection system's gravity lines were evaluated with respect to existing and future flows in the Waimanalo Wastewater Facilities Plan project. Based on the hydraulic analyses performed, the existing collection system is anticipated to be capable of handling the future year 2020 flow provided that the WWI/I problem upstream of the Kahawai Stream WWPS is resolved (see discussions in Chapter 2).

2. Waimanalo Wastewater Treatment Plant

The Waimanalo WWTP is located on a 10.1 acre site just off Kalaniana'ole Highway. The plant is bounded by Hihimanu Street to the south, a drainage channel, horse stable and homes to the east, and the Waimanalo Polo Field and residences to the north and west (see Figure 1-2b and 1-3). The construction of the treatment facility was completed in 1969. The facility was placed into operation in May of 1972.

The existing treatment facility provides secondary treatment utilizing a biological activated sludge process. The plant was originally designed to handle an average daily flow of 1.1 million gallons per day (MGD) but has subsequently been

"derated" to 0.7 mgd due to limitations of the biological secondary treatment process.

Existing liquid stream processing facilities include:

- Influent pump station,
- Grit/Screenings building, consisting of an aerated grit chamber and mechanically cleaned screen,
- Primary clarifiers,
- "Rapid Bloc" activated sludge system, consisting of aeration tanks and final clarifiers,
- Air blower building,
- Disinfection facilities, including gas chlorination facilities and chlorine contact tank, and
- Effluent injection wells.

Existing solids stream processing facilities include:

- Anaerobic digestion facilities, and
- Sludge drying beds.

Existing support facilities include:

- Emergency generator facilities, and
- Administration and laboratory building

As discussed in Chapters 1 and 2, the existing Rapid Bloc activated sludge system is currently experiencing operational problems that result in periodic effluent permit violations and accelerated clogging of the injection wells. Routine compliance monitoring is performed once per month. For a 14 month period reviewed (July 1995 through August 1996), the effluent composite samples for BOD₅ exceeded the 30 mg/L Underground Injection Control (UIC) permit limit for four months with values ranging from 32 to 65 mg/l. Total suspended solids (TSS) exceeded the 30 mg/L limit only once with a sample having a 48 mg/L TSS. It should be noted that effluent samples are analyzed only once per month. Since performance problems occur intermittently, the sampling program may not fully reflect the extent of the effluent degradation problems occurring at the Waimanalo WWTP. Due to the past history of periodic poor effluent quality, the

injection well clogging problems and capacity of the injection wells have been an ongoing concern.

3. Individual Wastewater Systems

Individual wastewater systems are widely used in the unsewered areas of Waimanalo. These systems, also referred to as onsite disposal systems,⁶ include primarily cesspools and septic tank systems. The following discussion provides an overview of individual wastewater systems and their use in Waimanalo.

a. Cesspools

Cesspools consist of cylindrical pits excavated in soil that are typically lined with concrete rings (with seepage openings), hollow tile blocks, or rocks (see Figure 3-13). In some geological formations such as coral or rock, the cesspool walls are unlined. Household wastewater discharged into the cesspool infiltrates into the surrounding soil through openings in the walls and floor of the unit. Inside the cesspool, treatment occurs as a result of organic and inorganic suspended solids settling to the bottom of the cesspool and through oxidation of soluble and suspended organic components of the wastewater. A biomat (slime layer) that develops on the infiltrative surfaces of the cesspool enhances biological treatment as seepage of wastewater into the soil occurs.

Further treatment of the effluent may occur outside the cesspool as the effluent flows through either the vadose zone or saturated soil. Particulate material in the effluent may be physically strained out or adsorbed by soil particles. Biological activity and chemical reactions in the soil result in further removal or transformation of contaminants. These reactions and transformations vary depending on environmental conditions in the soil and are generally site specific.

b. Septic Tank Systems

Septic tank systems generally consist of two components, the septic tank and the soil absorption disposal system (see Figure 3-14).

Septic tanks are buried, watertight tanks designed to anaerobically treat wastewater. Septic tanks for residential applications are typically prefabri-

⁶The State Department of Health has typically used the term "individual wastewater system" (IWS). EPA and the Hawaii Office of State Planning (Coastal Zone Management Program) has used the term "onsite disposal system" (OSDS). The terms are synonymous.

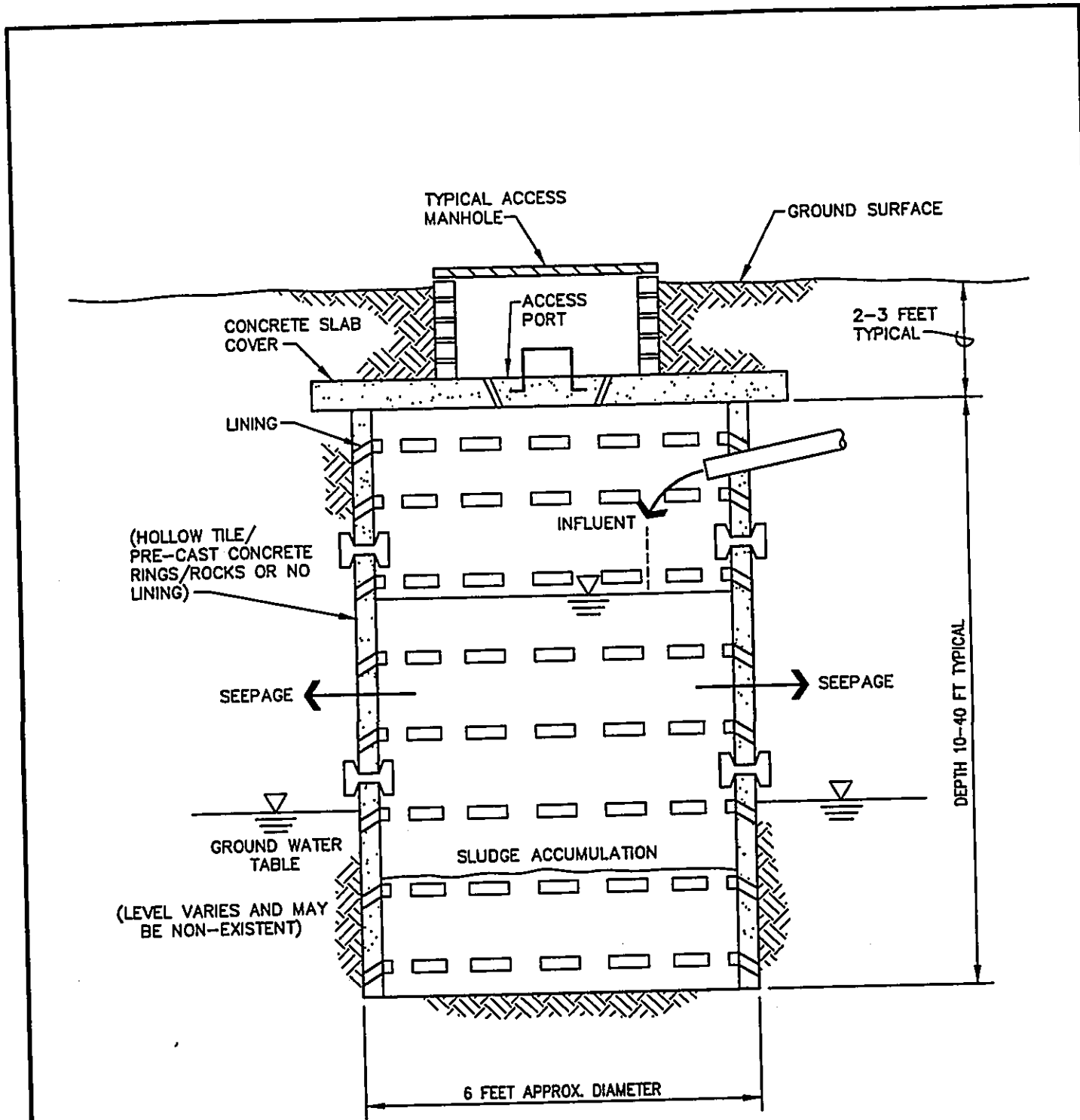

DATE: 4/20/88
 SCALE: 1" = 2.5'
 FILE: 9524-60A

RKA
 CDK
 PM: OPER:
 REVISED:

	Hawaii Pacific Engineers, Inc. CONSULTING ENGINEERS
	WAIMANALO WASTEWATER FACILITIES PLAN
TYPICAL CESSPOOL SYSTEM	
FIGURE 3-13	

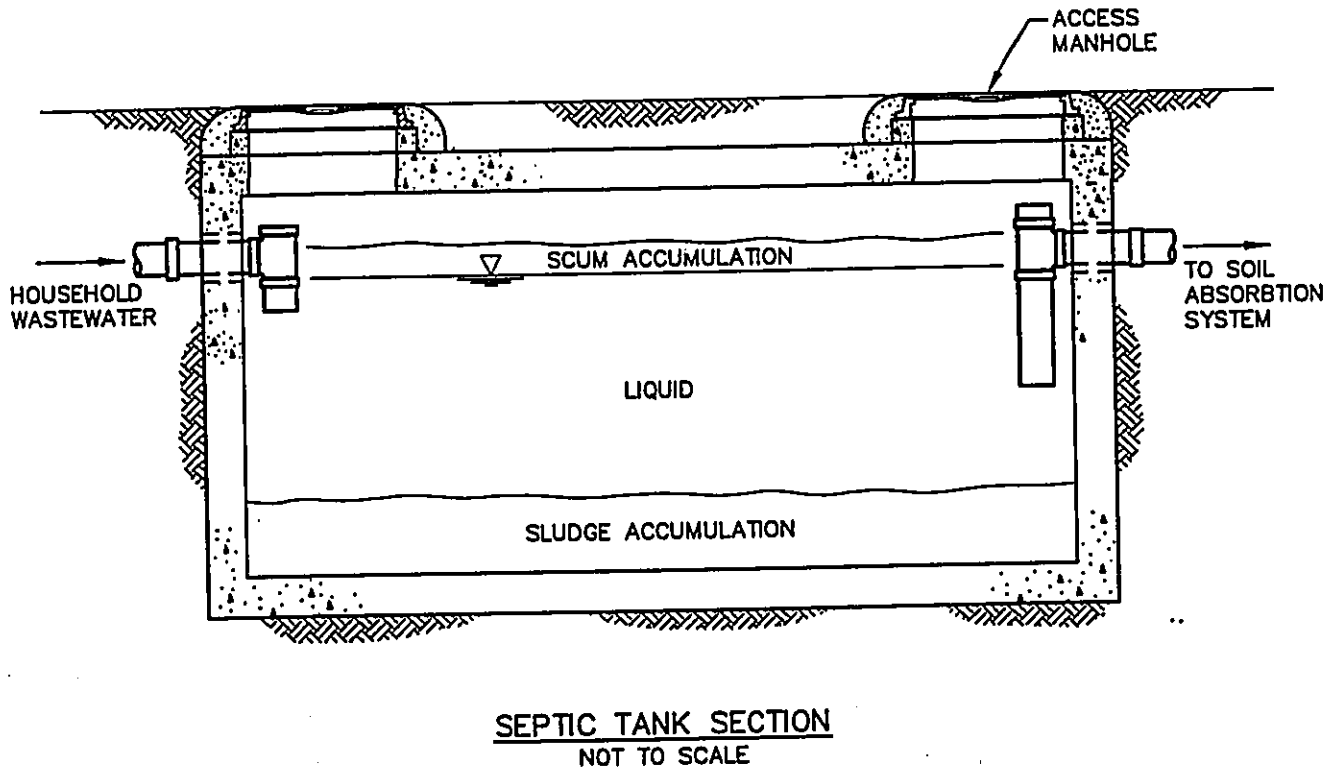
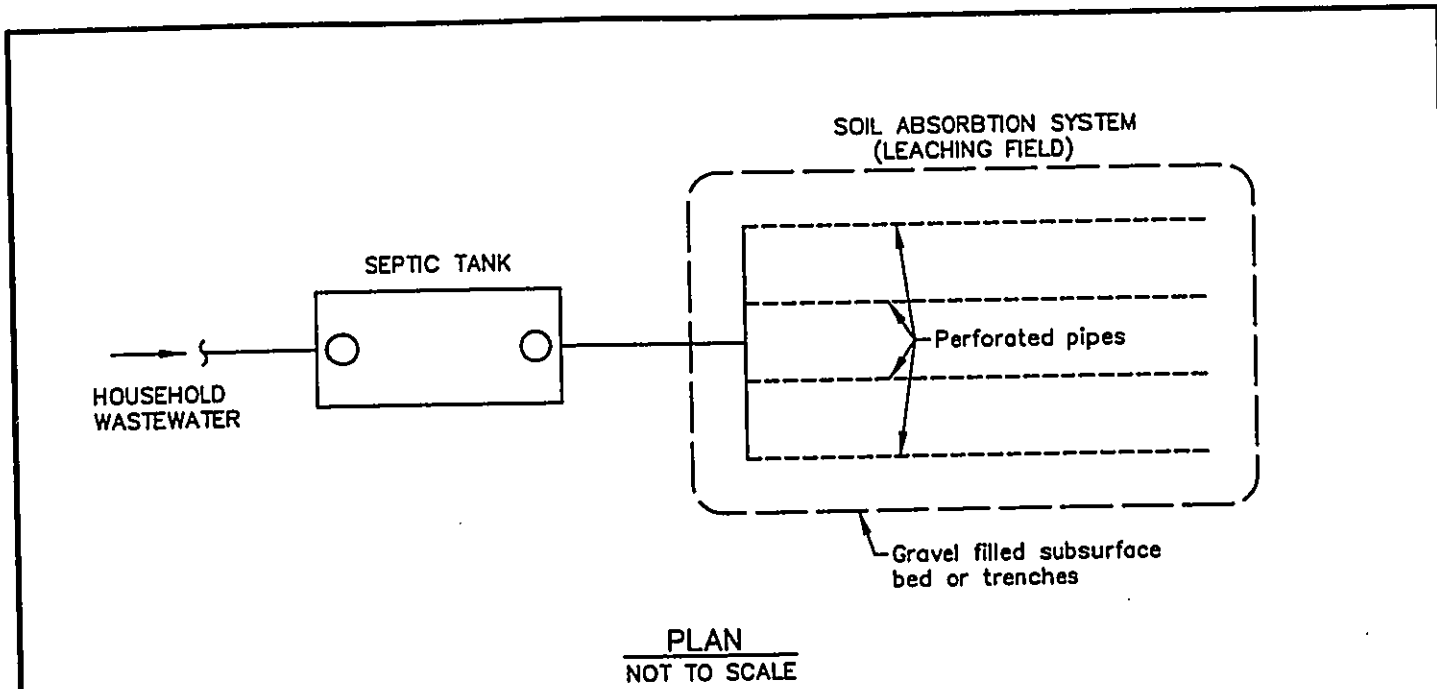

DATE: 4/20/98
 SCALE: 1/4" = 1'-0"
 FILE: 9524-61A

RKA
 PM: OPER: CDK
 REVISED:

	Hawaii Pacific Engineers, Inc. CONSULTING ENGINEERS
	WAIMANALO WASTEWATER FACILITIES PLAN TYPICAL SEPTIC TANK SYSTEM FIGURE 3-14

cated and constructed of concrete, fiberglass, polyethylene, or other corrosion resistant material. The tanks function as combined settling and skimming tanks and typically have volumes of 1,000 to 2,000 gallons for single family dwelling units. Generally, anaerobic conditions prevail in the septic tank, contributing to long term digestion of settled organic solids. The biodegradable constituents are converted to more stable compounds and gases such as carbon dioxide (CO₂), methane (CH₄) and hydrogen sulfide (H₂S).

Final treatment and disposal of the effluent from the septic tank is generally accomplished by a soil absorption system. The most common soil absorption system is a leaching field consisting of either a series of narrow, relatively shallow trenches or simple subsurface beds filled with a porous medium (usually gravel). Effluent from the septic tank is distributed within the leaching trenches or beds via perforated piping and allowed to infiltrate into the soil. Septic tanks may also discharge effluent to seepage pits, which are generally identical to cesspools in construction.

Treatment mechanisms in the soil absorption system are similar to those previously described for cesspools. The geometry of leaching trenches and beds facilitates the construction of these systems above the water table. This permits percolation of effluent through a wider band of the vadose zone which in turn increases the level of treatment.

c. Number and Location of Cesspools and Septic Tank Systems

It is estimated that about 35 percent of Waimanalo's current estimated planning area population of 9,400 reside in unsewered areas served by individual wastewater systems. The majority of the existing individual wastewater systems in Waimanalo consist of cesspools.

The estimated number of individual wastewater systems in Waimanalo is summarized in Table 3-12. This estimate is based on the assumption that each dwelling unit in the unsewered areas is serviced by an individual wastewater system. The estimate of the number of homes on individual wastewater systems in sewerred areas is based on the sewer service connection data provided by the City Department of Planning and Permitting. Homes that have not connected to the sewer system are assumed to be serviced by individual wastewater systems. City records show that 1,179 sewer connections are available in the Waimanalo service area. An estimated 196 homes, or nearly 17 percent of the homes in sewerred areas remain unconnected.

**TABLE 3-12
ESTIMATED INDIVIDUAL WASTEWATER SYSTEMS IN WAIMANALO**

Area ¹	Number of Individual Wastewater Systems ²	Estimated Population Served
UNSEWERED AREAS:		
Waimanalo Sewers Section 2 Improvement District	348	1,322
Waimanalo Sewers Section 3 Improvement District	34	129
Waimanalo Sewers Section 5 Improvement District	65	293
Miscellaneous Single Family Lots	25	113
Private Agricultural Lots	425	1,403
Bellows Air Force Station ³	<u>12</u>	<u>--</u>
Subtotal	909	3,260
SEWERED AREAS:		
Inoaole Subdivision	1	5
Waimanalo Village Subdivision Units I, II, III, Waimanalo Self Help Housing	3	14
Waimanalo Sewer Section I, Waimanalo Core Development 1A, 1B	11	50
Makapuu Interceptor Sewer Section I	23	104
Waimanalo Residence Lot Unit I	35	158
Waimanalo Residence Lot Unit II	45	203
Waimanalo Residence Lot Unit III	41	185
Waimanalo Residence Lot Unit IV	29	131
Waimanalo Residence Lot Unit VI	6	27
Waimanalo Residence Lot Unit VII	<u>2</u>	<u>9</u>
Subtotal	196	886
TOTAL	1,105	4,146

Notes:

1. See Figure 3-11 for location of areas.
2. Estimated number of systems is based on assuming one system per dwelling unit. See Chapter 6 for basis of number of dwelling units and household sizes.
3. Population serviced by individual wastewater systems at the Bellows Air Force Station primarily service transient accommodations and was not researched in detail. Sea Life Park, Makai Pier and Olomana Golf Links are served by "package type" aerobic treatment systems and are not included in the table.

d. Number and Location of Defective Cesspools

According to DOH policy, a cesspool that requires pumping more than once per year is considered to be defective (Tulang, 1996). This criteria may be relaxed to more than two pumpings per year in the proposed revised Chapter 62 regulations currently under development.

The City's Department of Environmental Services (ENV) cesspool pumping records summarized on Table 3-13 for the 1995 calendar year indicate the typical number and frequency of cesspool pumpings in Waimanalo. The data indicates that 71 cesspools of the estimated 1,105 individual wastewater systems (6.4 percent) required pumping at least once in 1995. Of the pumped cesspools, 55 (5 percent of the total) required more than one pumping during the year. Cesspools pumped on a contract basis accounted for the majority of the pumpings.⁷

The addresses of 197 homes, or about 18 percent of the total number of homes estimated to be on individual wastewater systems, were found on the City's cesspool pumping records. This indicates that 126 (197 minus 71) or about 64 percent of the homes which were pumped in the past were not serviced in 1995. It can be concluded that the majority of cesspools which require pumping do not require pumping every year.

The actual percentage of defective cesspools is probably slightly greater than five percent since the figures used in the above analysis only reflect the activities of the City's cesspool pumping services. Residents may also choose to have their cesspools pumped by one of the many higher cost private services available.

Significant cesspool failures, those defined in this study as requiring pumping more than five times per year, are generally located in the following areas:

- Waimanalo Beach Lots near Kalaniana'ole Highway between Ehukai and Kaulu Streets
- Flamingo Street area
- Widely scattered areas in the upper agricultural lands

⁷Homeowners may choose to either pay a fixed charge for each cesspool pumping or pay a flat monthly fee which entitles them up a maximum of three pumpings per month.

**TABLE 3-13
SUMMARY OF CITY CESSPOOL PUMPINGS
IN WAIMANALO DURING 1995**

Number of Pumpings During 1995	Homes Serviced on Per Call Basis (Non-contract)		Homes Serviced on Contract Basis		Total Number of Calls	Total Number of Pumpings
	Number of Homes	Number of Pumpings	Number of Homes	Number of Pumpings		
1	3	3	13	13	16	16
2	4	8	2	4	6	12
3	2	6	3	9	5	15
4	0	0	1	4	1	4
5	2	10	10	50	12	60
6	0	0	4	24	4	24
7	1	7	3	21	4	28
8	0	0	0	0	0	0
9	0	0	2	18	2	18
10	0	0	3	30	3	30
12	0	0	3	36	3	36
13	0	0	4	52	4	52
16	0	0	1	16	1	16
18	0	0	1	18	1	18
20	0	0	1	20	1	20
21	0	0	1	21	1	21
28	0	0	1	28	1	28
29	0	0	1	29	1	29
31	0	0	1	31	1	31
38	0	0	1	38	1	38
43	0	0	1	43	1	43
46	0	0	1	46	1	46
52	0	0	1	52	1	52
Total	12	34	59	603	71	637

Source: Cesspool pumping records of the Division of Collection System Maintenance, Department of Wastewater Management, City and County of Honolulu

Figure 3-15 shows the general location of the problem areas based on a review of 1995 cesspool pumping records.

e. DOH Stance on Reducing the Use of Cesspools

The design and installation of individual wastewater systems are regulated by the DOH under Chapter 62, "Wastewater Systems." The currently applicable Chapter 62 provisions, which were adopted in August 1991, prohibit or severely restrict the construction of new cesspools in "Critical Wastewater Disposal Areas" (CWDA). The DOH has designated the entire island of Oahu as a CWDA. CWDA areas were established by DOH based on one or more of the following concerns:

- High water table
- Impermeable soil or rock formation
- Steep terrain
- Flood zone
- Protection of coastal waters and inland surface waters
- High rate of cesspool failures
- Protection of groundwater resources

Chapter 62 further notes DOH's stance on restricting the use of cesspools in its preamble, which states:

"The State Department of Health seeks to migrate towards an ultimate goal of regional sewage collection, treatment and disposal systems which are consistent with state and county wastewater planning policies."

"A goal has been established such that the construction of wastewater disposal systems depositing untreated sewage into the environment will not be allowed after the year 2000."

The State and City planning policies on wastewater management are embodied in the 208 Plan for the City and County of Honolulu. The 208 Plan views the use of cesspools as a significant threat to water quality and public health and includes extensive discussions of methods to reduce the use of cesspools on Oahu.

DATE: 4/20/98
SCALE: 1" = 4000'
FILE: 9324-37A

PI: BKA
OPER: CDK
REVISED: -

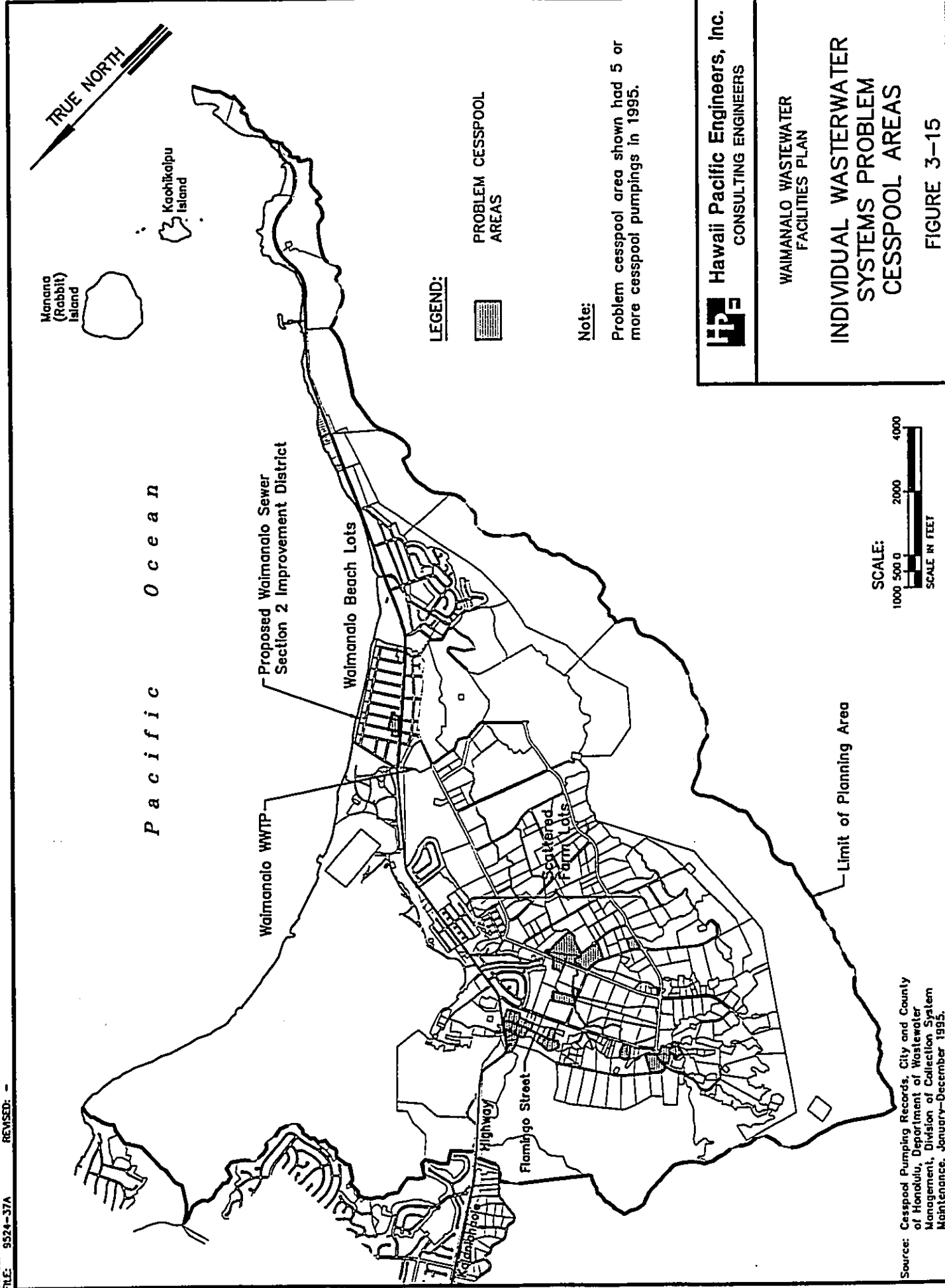

LEGEND:
[Hatched Box] PROBLEM CESSPOOL AREAS

Note:
Problem cesspool area shown had 5 or more cesspool pumpings in 1995.

HPE Hawaii Pacific Engineers, Inc.
CONSULTING ENGINEERS

WAIMANALO WASTEWATER FACILITIES PLAN
INDIVIDUAL WASTEWATER SYSTEMS PROBLEM CESSPOOL AREAS
FIGURE 3-15

SCALE:
1000 500 0 2000 4000
SCALE IN FEET

Source: Cesspool Pumping Records, City and County of Honolulu, Department of Wastewater Management, Division of Collection System Maintenance, January-December 1995.

The Waimanalo Wastewater Facilities Plan evaluated the use of cesspools in considerable detail. As discussed in Chapter 1, 2 and 5, further investigations are recommended to determine the environmental impacts of cesspools and the potential benefits of constructing sewers to serve existing unsewered homes in the coastal areas.

Drainage Facilities and Flood Control

Storm drainage facilities are relevant to wastewater facilities planning in the Waimanalo area due to both water quality and sewer wet weather infiltration/inflow impacts. The City Department of Public Works installs and maintains storm drains in Waimanalo. Storm drains in Waimanalo that discharge to adjacent streams or drainage ditches are shown on Figure 3-16.

Polluted overland storm runoff, described as non-point source pollution, is a significant concern from a water quality standpoint. Storm drains located within City-owned public right-of-way in residential areas of Waimanalo are included under a municipal National Pollutant Elimination System (NPDES) permit issued to the City by the DOH in accordance with Hawaii Administrative Rules Title 11, Chapter 55, "Water Pollution Control." Individual NPDES permits are not required for each City storm drain discharge point. Water quality impacts of stormwater runoff are discussed in Chapter 5.

During past severe storms, there has been extensive damage to residential and commercial properties, agricultural crops, livestock, roads and highways, automobiles, fences, bridges, and the shoreline. Portions of Waimanalo are not served by storm drains, or by storm drains that are unable to accommodate all the storm runoff during extreme rainfall events. In particular, the areas around Poalima Street and Mekia Street near Kahawai Stream and Kalaniana'ole Highway frequently flood during storm events.

A flood control and flood water conservation plan was prepared in 1983 by the State Department of Land and Natural Resources, Division of Water and Land Development (DLNR, 1983). The plan, which supplements a 1976 flood control project document (Fukunaga & Associates, 1976), describes flood control progress made to date in Waimanalo. Projects completed included concrete lining of 1,200 feet of Waimanalo Stream, and 2,800 feet of Muliwaiolena Stream. The plan recommends flood plain zoning along Waimanalo, Inoaole and the Muliwaiolena Stream and their tributaries, construction of concrete channel, surveillance during tsunamis, small craft and surf warnings, organization of a flood fighting unit, and practicing proper soil conservation measures to help retard and reduce surface and sediment runoff.

DATE: 09/30/96 MS
 SCALE: 1" = 2000' SHA, CCK
 FILE: 9524-29A REVISED: 4/20/98

HPE Hawaii Pacific Engineers, Inc.
 CONSULTING ENGINEERS

WAIMANALO WASTEWATER
 FACILITIES PLAN
**EXISTING STORM DRAINAGE
 FACILITIES AND DRAINAGE
 WATERWAYS**

FIGURE 3-16

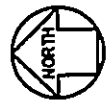

GRAPHIC SCALE:

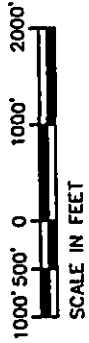

Pacific Ocean

LEGEND

- STORM DRAIN LINE AND LINE SIZE
- STREAM OR DRAINAGE CHANNEL

Note:
 Drainage facilities shown are based on record drawings from City Department of Public Works. The facilities shown were not field verified and other drain lines not shown may exist.

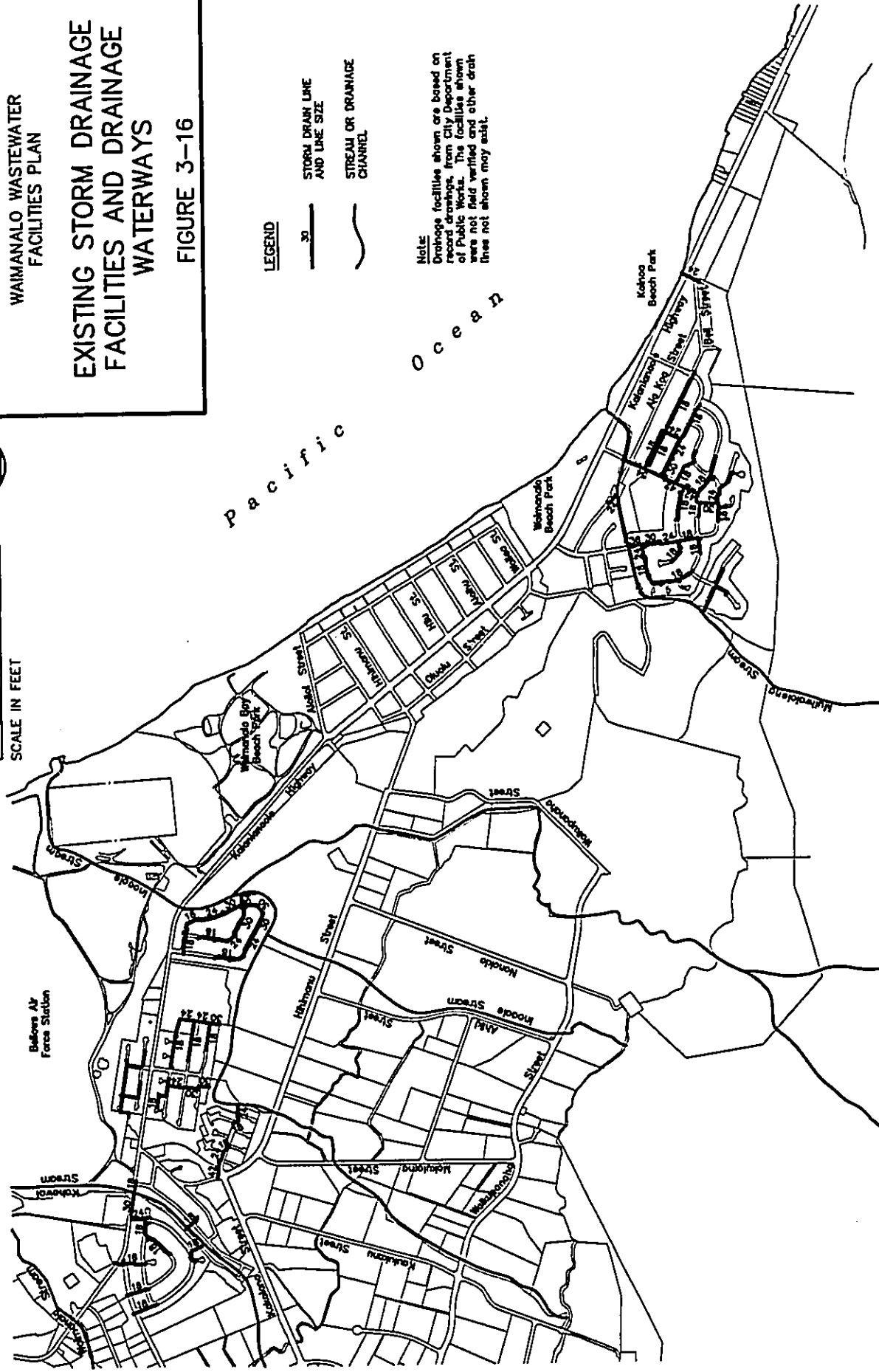

Source: Storm Drainage Maps,
 City and County of Honolulu
 Department of Public Works,
 September, 1996.

Flood plains and floodways for the Waimanalo planning area, as delineated on the Flood Insurance Rate Map (FIRM) prepared by the Federal Emergency Management Agency (FEMA), are shown on Figure 3-17. The existing Waimanalo Wastewater Treatment Plant is located within an area of 100-year shallow flooding where the depth of inundation averages one foot (Zone AO). The site, however, is not located within the coastal high hazard zone or tsunami inundation area. Drainage and mitigation of flooding problems at the treatment plant site are discussed in Chapter 5.

The City Department of Planning and Permitting anticipates that the FIRM flood designation for the Waimanalo WWTP site will be revised in the future based on a March 1997 flood study by the U.S. Army Corps of Engineers (DLU, 1998; R.M. Towill, 1997). The new study places the Waimanalo WWTP in Zone AE (flood fringe and floodway) with a regulatory flood elevation several feet higher than the current Zone AO flood elevation.

A portion of the precipitation that falls during storm events drains to the sanitary sewer system as infiltration/inflow. Generally storm water enters the sewer system through defects in the sewer pipe or manholes, or through illegal connections to the sewer system, such as roof drains. In some cases residents may use sewer lateral cleanouts as yard drains or manholes as area drains. Infiltration/inflow is undesirable because it displaces wastewater flow capacity in the conveyance system and treatment capacity at the WWTP. Improved storm drains and flood control systems in combination with other measures could reduce infiltration/inflow to the sewer system. Due to funding limitations, however, the reduction of infiltration/inflow to sewers through drainage improvements is not anticipated to occur in the foreseeable future in Waimanalo.

Solid Waste Disposal/Reuse

Solid waste generated on Oahu is currently disposed at two City facilities: the Waimanalo Gulch Sanitary Landfill located in Nanakuli, and the H-Power facility at Campbell Industrial Park. Ash from the H-Power facility is landfilled at the Waimanalo Gulch Sanitary Landfill. Refuse is no longer being landfilled at the City's Kapaa Sanitary Landfill site.

The Waimanalo Gulch Sanitary Landfill is expected to reach its capacity within eight to ten years. The Department of Environmental Services has not yet designated a site to replace the Waimanalo Gulch facility.



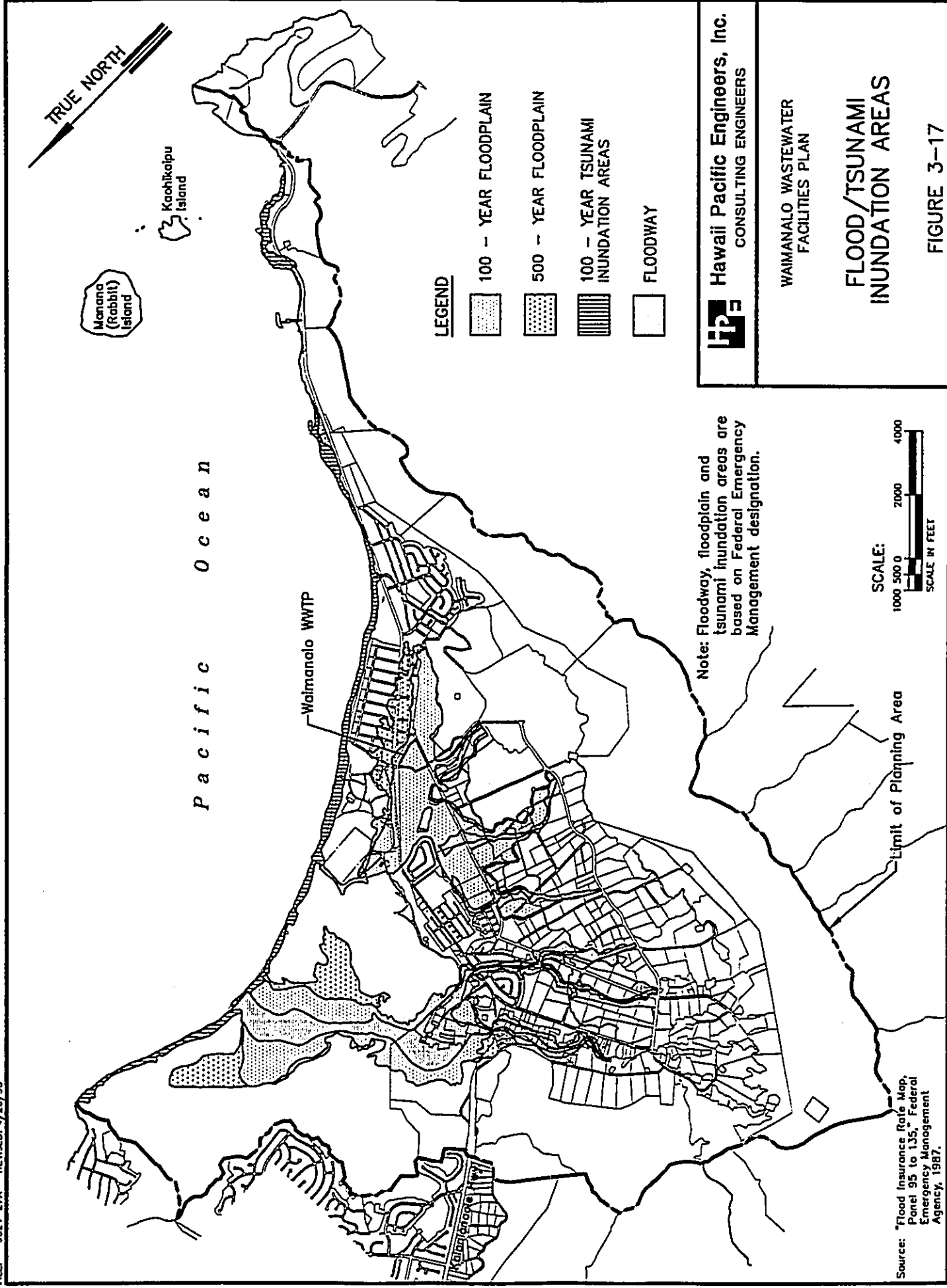

Stabilized dewatered wastewater sludge from City wastewater treatment facilities is currently landfilled at the Waimanalo Gulch Landfill. Alternatives related to the disposal of sludge from the Waimanalo WWTP were discussed in Chapter 2.

DATE: 9/27/96
 SCALE: 1" = 4000'
 FILE: 9524-27A

PU: RKA
 OPER: SHA/CDK
 REVISED: 4/20/98



LEGEND

-  100 - YEAR FLOODPLAIN
-  500 - YEAR FLOODPLAIN
-  100 - YEAR TSUNAMI INUNDATION AREAS
-  FLOODWAY

Note: Floodway, floodplain and tsunami inundation areas are based on Federal Emergency Management designation.

SCALE:
 1000 500 0 2000 4000
 SCALE IN FEET

Source: "Flood Insurance Rate Map, Panel 95 to 135," Federal Emergency Management Agency, 1987.

HP Hawaii Pacific Engineers, Inc.
 CONSULTING ENGINEERS

WAIMANALO WASTEWATER FACILITIES PLAN

FLOOD/TSUNAMI INUNDATION AREAS

FIGURE 3-17

Transportation Facilities

Waimanalo is located approximately 14 miles from downtown Honolulu via the Pali Highway (State Route 61). Kalaniana'ole Highway (State Route 72) *in the eastbound direction* is the other route to Honolulu and extends around Makapuu Point approximately 20 miles to downtown. Kalaniana'ole Highway is the major thoroughfare in Waimanalo. Residential and commercial developments have been established along both sides of the highway in Waimanalo to form a linear or strip pattern of urbanization.

The State Department of Transportation is planning to evaluate various Kalaniana'ole Highway improvement projects within Waimanalo to better accommodate projected increases in traffic. Alternatives under consideration include widening the existing highway from two to four lanes, improving the existing two-lane highway by incorporating turn lanes and bus pullouts, and realigning the highway. Construction of the highway improvements, if approved and funded, is not scheduled to begin until at least year 2007 (Honolulu Advertiser, November 1996).

Electrical Utilities

Hawaiian Electric Company (HECO) provides electrical power within the Waimanalo area. There is a HECO 500 KVA transformer which presently serves the Waimanalo WWTP.

Recreational Facilities

The Waimanalo planning area includes numerous shoreline and inland recreational facilities. Shoreline facilities include beach parks offering recreational activities such as swimming, body surfing, board surfing, board sailing, snorkeling, walking, boating and camping. Fishing from shore is also a popular activity. Inland recreational resources include the Olomana Golf Links, Waimanalo Polo Field, playgrounds and district parks, and hiking and biking trails located in the Waimanalo Forest Reserve. The major recreational facilities in the Waimanalo are listed in Table 3-14.

Beach parks are of particular interest for wastewater management planning as they are the major impetus for improving nearshore water quality. The Urban Design Branch of the City Department of Parks and Recreation Services conducted surveys at three Waimanalo beach parks from July 1, 1994 through June 30, 1995. The results of those surveys, indicating the number of visitors using the beaches are given below.

**TABLE 3-14
EXISTING RECREATIONAL AND OPEN SPACE RESOURCES IN THE
WAIMANALO PLANNING AREA**

Recreational and Open Space Resources	Organizational or Governmental Jurisdiction	Acreage	Comments
Bellows Air Force Station	Federal	32	
Waimanalo Bay Beach Park	City and County	124	Camping permitted
Waimanalo Forest Reserve	State	3,293	
Bellows Field Beach Park	City and County	54	
Kaiona Beach Park	City and County	4	State land/City operated
Kaupo Beach Park	City and County	8	State land, undeveloped
Makapuu Beach Park	City and County	47	State land/City operated
Waimanalo Community Beach Park	City and County	38	
Waimanalo District Park	City and County	25	
Olomana Golf Links	Private	130	State land
Waimanalo Polo Field	Private	34	State land

Source: Aotani & Hartwell Associates, Inc., 1975. Updated in February 1982 by Wilson Okamoto & Associates and 1996 by Hawaii Pacific Engineers.

Beach Park	Tax Map Key	Visitor Count
Bellows Beach Park	4-1-15:9	115,000
Waimanalo Bay Beach Park (formerly Waimanalo Bay State Recreation Area)	4-1-15:15	273,000
Makapuu Beach Park	4-1-14:2,5	314,000

Bellows Beach Park facilities are open only on weekends and holidays. The other two parks are open throughout the year. Although Makapuu Beach is much smaller than the other beaches listed, it is very popular with surfers and bodysurfers, and accounts for much of the high visitor count. Kaupo Beach Park, which was not included in the surveys, has a narrower, rockier beach with higher surf than the others and has 30 to 50 percent less visitors per lineal yard of beach than other beaches (City and County of Honolulu, Department of Parks and Recreation, 1996a). Waimanalo Beach Park, which also was not included in the survey, is estimated to have considerably higher visitor counts than the Waimanalo Bay Beach Park (formerly Waimanalo Bay State Recreation Area). For the purposes of estimating wastewater flows, the Waimanalo Beach Park was conservatively estimated to have approximately 500,000 visitors annually.

None of the recreational facilities currently discharge wastewater to the Waimanalo collection system, with the exception of the Waimanalo Bay Beach Park. The Waimanalo Bay Beach Park pumps wastewater from restrooms to the collection system via three small submersible pump stations. Olomana Golf Links has its own private treatment plant to treat domestic waste from the clubhouse. The remaining park facilities utilize individual wastewater systems.

Historic Sites and Archeological Resources

The criteria for eligibility to be listed in the National Register of Historic Places is defined in 36 CFR 60.4. *Properties* are considered to be historically significant if:

"The quality of significance in American history, architecture, archeology, engineering, and culture is present in districts, sites, buildings, structures, and objects that poses integrity of location, design, setting, materials, workmanship, feeling and association, and

- (a) that are associated with events that have made a significant contribution to the broad patterns of our history; or*
- (b) that are associated with the lives of persons significant to our past; or*

- (c) *that embody the distinctive characteristics of a type, period, or method of construction, or that represent the work of a master, or that possess high artistic values, or that represent a significant and distinguishable entity whose components may lack individual distinction; or*
- (d) *that have yielded, or may be likely to yield, information important in prehistory or history."*

Seven historic sites in the Waimanalo planning area, which include archeological sites, have been placed on the Hawaii and/or National Register of Historic Places. These sites are listed in Table 3-15 and shown on Figure 3-18.

Archaeological sites located within Bellows AFS include ten Hawaiian sites, three sites related to the Waimanalo Sugar Plantation and five sites related to military history. The archaeological sites were evaluated by the International Archaeological Research Institute, Inc. (IARII), a subconsultant to Belt Collins Hawaii. The report was published in 1994. The Bellows AFS archaeological area has been important to Hawaiian archaeology because it is the oldest dated site in the Hawaiian Islands. The majority of the Hawaiian sites at Bellows AFS are subsurface deposits rather than surface structures. The investigations indicate that the Bellows AFS lowlands may have comprised a single site at one time. Agricultural development followed by construction activities during World War II had a major effect on archaeological remains. Much of the area was leveled or filled, and Waimanalo Stream was rechanneled at its mouth. In spite of the construction, significant deposits from earlier periods are thought to remain. Further testing on the Bellows Air Force Station archeological sites to determine the actual boundaries was conducted by IARII and reported in 1998.

Comments on the Draft Supplemental Environmental Impact Statement (DSEIS) were submitted by the State Historic Preservation Division (SHPD) (see correspondence in Chapter 10). The SHPD indicated that additional historic sites not listed on the Hawaii or National Register of Historic Places are known to exist in the project area, especially in areas seaward (makai) of Kalaniana'ole Highway. It was further indicated that current work in the Bellows Air Force Station area is providing additional information on Hawaiian prehistory and history. To date, these studies have clearly shown the existence of extensive if discontinuous cultural deposits underlying the Jaucas sand.

Air Quality

Waimanalo is not situated within an air quality maintenance or non-attainment area designated by DOH. Vehicular traffic is the major source of air pollutants in Waimanalo. However, the impact of this pollution source is not considered to be significant. Limited air pollution sources exist due to the rural character of the area

**TABLE 3-15
HISTORIC PLACES IN THE WAIMANALO PLANNING AREA**

Hawaii Register of Historic Places No.	Site	Location	Register Status*
80-15:382	Pohakunui Heiau	4-1-27:22	S, A
80-15:489,490	Koa (Rabbit Island)	4-1-14:09	S
80-15:511	Bellows Field Archaeological Area	4-1-15:1,15	N
80-15:516	Waimanalo Taro Terraces	4-1-10:01	S
80-15:1031	Heiau	4-1-08:5	S
80-15:1037	Pahonu Turtle Pond	4-1-02:7	S, A
80-15:4042	Waimanalo Ditch System	4-1-10: Various	N

***Abbreviations:**

S = Placed on the Hawaii Register of Historic Places.

N = Placed on the National Register of Historic Places.

A = Recommended for nomination to the National Register.

Source: Hawaii Historic Places Review Board, Hawaii Register of Historic Places.
Revised November 1993.

DATE: 01/05/98
 SCALE: 1" = 4000'
 FILE: 9524-91

PM: RKA
 OPER: SHA, CDK
 REVISED: 4/20/98

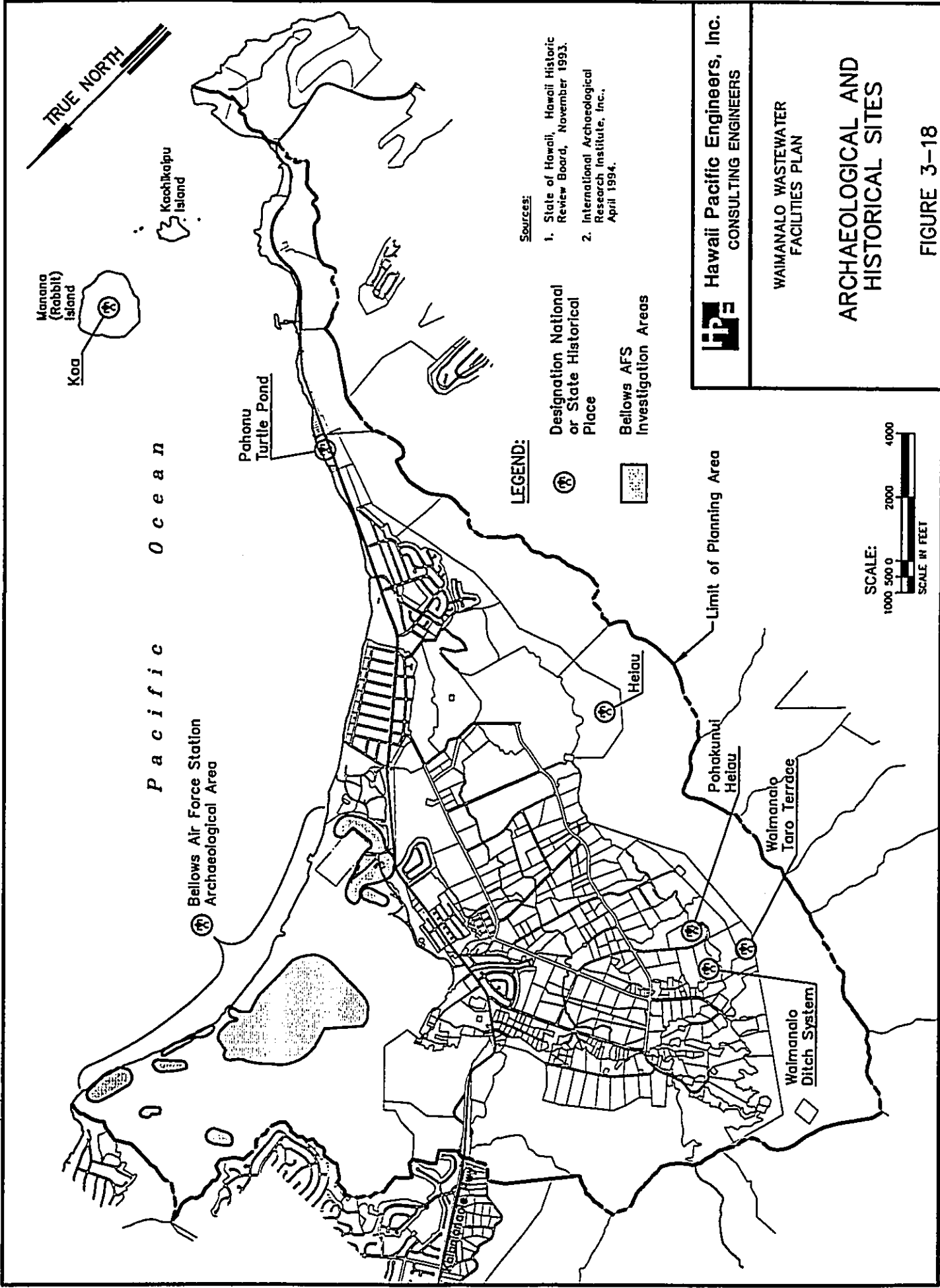

Sources:
 1. State of Hawaii, Hawaii Historic Review Board, November 1993.
 2. International Archaeological Research Institute, Inc., April 1994.

LEGEND:
 (⊗) Designation National or State Historical Place
 [Stippled Area] Bellows AFS Investigation Areas
 [Dashed Line] Limit of Planning Area

HPE Hawaii Pacific Engineers, Inc.
 CONSULTING ENGINEERS

WAIMANALO WASTEWATER FACILITIES PLAN

ARCHAEOLOGICAL AND HISTORICAL SITES

FIGURE 3-18

and the prevailing northeast tradewinds help to keep air pollution levels low. This is confirmed by air quality samples of particulate matter collected at a monitoring site located at the Waimanalo WWTP. According to the State DOH data, none of the 143 samples collected from January 1991 to December 1993 exceeded the Hawaii State air quality standards (DOH, Clean Air Branch). The State standards are 150 mg of particulate matter less than 10 microns in diameter per cubic meter over 24-hours, and 50 mg per cubic meter on an annual arithmetic average basis.

The Waimanalo WWTP has not received any complaints of odor originating at the plant in the past ten years (Hawkins, 1996). However, residents have complained about odors from the Unisyn Biowaste Technology organic waste processing facility, a dairy farm, and pig farms. The Waimanalo Neighborhood Board and many Waimanalo residents have opposed the continued operation of the Unisyn facility due to odor and health concerns. The potential for odors from the Waimanalo WWTP is discussed in further detail in Chapter 5.

Noise Levels

Existing noise levels in Waimanalo are generally low as a result of the rural nature of the community. Vehicular traffic is the primary noise generator in the area, particularly along the major thoroughfare, Kalaniana'ole Highway. There have been no complaints of noise attributed to the Waimanalo WWTP.

Chapter 4

**Relationship to
Land Use Plans, Policies and Controls**

CHAPTER 4

RELATIONSHIP TO LAND USE PLANS, POLICIES AND CONTROLS

GENERAL

Analysis of land use plans, policies and controls for Waimanalo was a key step in assessing the existing and projected population distribution and the future demands to be placed on the wastewater facilities. This chapter describes the current status of State, City and Federal land use plans and policies, and the relationship of the proposed action to applicable land use controls. A summary of the approvals anticipated to be required for the proposed action is included at the end of the chapter.

Land use in Hawaii is primarily regulated at the state and county levels. The applicable land use regulations and policies will vary depending on ownership of the land. As indicated in Chapter 3, the majority of the land in Waimanalo is owned by the State of Hawaii and much of the future development will be performed by the State Department of Hawaiian Home Lands (DHHL).

EVALUATION OF STATE LAND USE PLANS AND POLICIES

Land Use Classifications

General land use in Hawaii is classified at the State level by the State Land Use Commission into four State Land Use Districts: 1) urban, 2) rural, 3) agriculture, and 4) conservation. Estimated acreages for the districts in Waimanalo are shown in Table 4-1. The State Land Use districts for Waimanalo are delineated on Figure 4-1. Urban lands encompass most of the Waimanalo coastal plains area, including the Bellows Air Force Station (AFS). The Waimanalo Wastewater Treatment Plant (WWTP) and Kahawai Wastewater Pump Station are located on urban lands.

State Land Use Planning/Development Practices and Policies

State lands are administered by various agencies depending on the land use. In Waimanalo, a number of key State agencies are involved in planning and development activities. Agricultural land is administered by the State Department of Agriculture. Hawaiian Home Lands residential developments are planned and developed by the State Department of Hawaiian Home Lands (DHHL). Certain mixed use developments for people of Hawaiian descent are administered by the Office of Hawaiian Affairs (OHA). The Department of Land and Natural Resources is tasked with management

**TABLE 4-1
STATE LAND USE DISTRICTS IN THE WAIMANALO PLANNING AREA**

State Land Use District	Land Area (acres)	Percent of Total
Urban	2,346	33
Rural	0	0
Agricultural	2,413	34
Conservation	2,334	33
Total	7,093	100

Source: State of Hawaii, Land Use Commission, USGS Quadrangle Maps 014 (Makapuu) and 015 (Koko Head), 1995.

DATE: 10/18/95
 SCALE: 1" = 4000'
 FILE: 9524-01A

RIKA
 PU:
 OPER: SHA FA • CDK
 REISED: 4/20/98

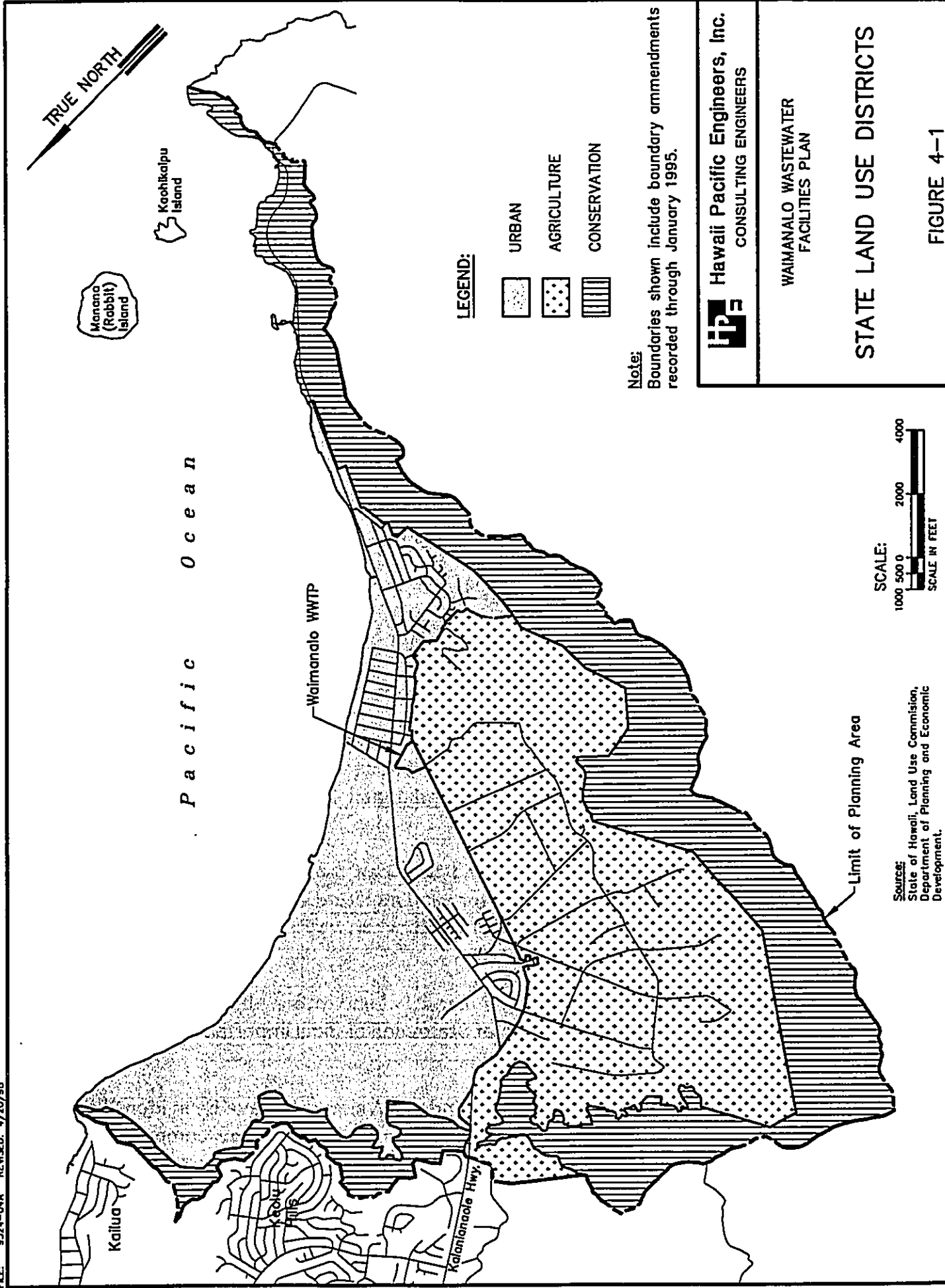

HPE Hawaii Pacific Engineers, Inc.
 CONSULTING ENGINEERS

WAIMANALO WASTEWATER
 FACILITIES PLAN

STATE LAND USE DISTRICTS

FIGURE 4-1

SCALE:
 1000 500 0 2000 4000
 SCALE IN FEET

Source:
 State of Hawaii, Land Use Commission,
 Department of Planning and Economic
 Development.

of most other State lands in Waimanalo and provides support to the various State agencies for development and management of infrastructure. The proposed action of the Waimanalo Facilities Plan is consistent with the plans of the various State agencies and will provide the necessary wastewater infrastructure support for the proposed developments.

The DHHL has been the major developer of residential properties in Waimanalo in the past and it appears that they will continue to be the area's primary developer of housing in the future. DHHL developments are exempt from State and County land use regulations. DHHL has planned housing developments in Waimanalo that, if implemented, would result in more urbanized land than currently projected by the City Planning Department. The proposed DHHL developments were addressed in the discussions on population projections in previous chapter. The Planning Department is attempting to work closely with DHHL in preparing revisions to the City's Koolaupoko Development Plan (see discussions below). The past policy of the Planning Department has been to generally recognize DHHL projects at the time of actual execution since implementation of DHHL projects has historically lagged substantially behind DHHL's long range projections.

Agricultural Lands of Importance (ALISH)

Agricultural lands are classified according to the Agricultural Lands of Importance to the State of Hawaii (ALISH) system. There are three classes of agriculturally important lands: prime, unique, and other important agricultural lands.

- Prime Agricultural Land: Land which has the soil quality, growing season, and moisture content needed to produce sustained high yields of crops economically when treated and managed according to modern farming methods.
- Unique Agricultural Land: Land that has the special combination of soil quality, location, growing season, and moisture supply necessary to produce sustained high quality and high yields when treated and managed according to modern farming methods.
- Other Important Agricultural Land: Land other than Prime or Unique Agricultural Land that is also of Statewide or local importance for agricultural use.

Prime and Other Important Agricultural Lands in Waimanalo have been identified and are shown on Figure 4-2. These two agricultural land classes comprise a major portion of the Waimanalo valley floor. Approximately 2,170 acres, excluding military

DATE: 10/18/96 PM: RKA
SCALE: 1"=4000' OPER: SHALFAL*CDK
FILE: 9524-2JA REVISED: 3/27/98

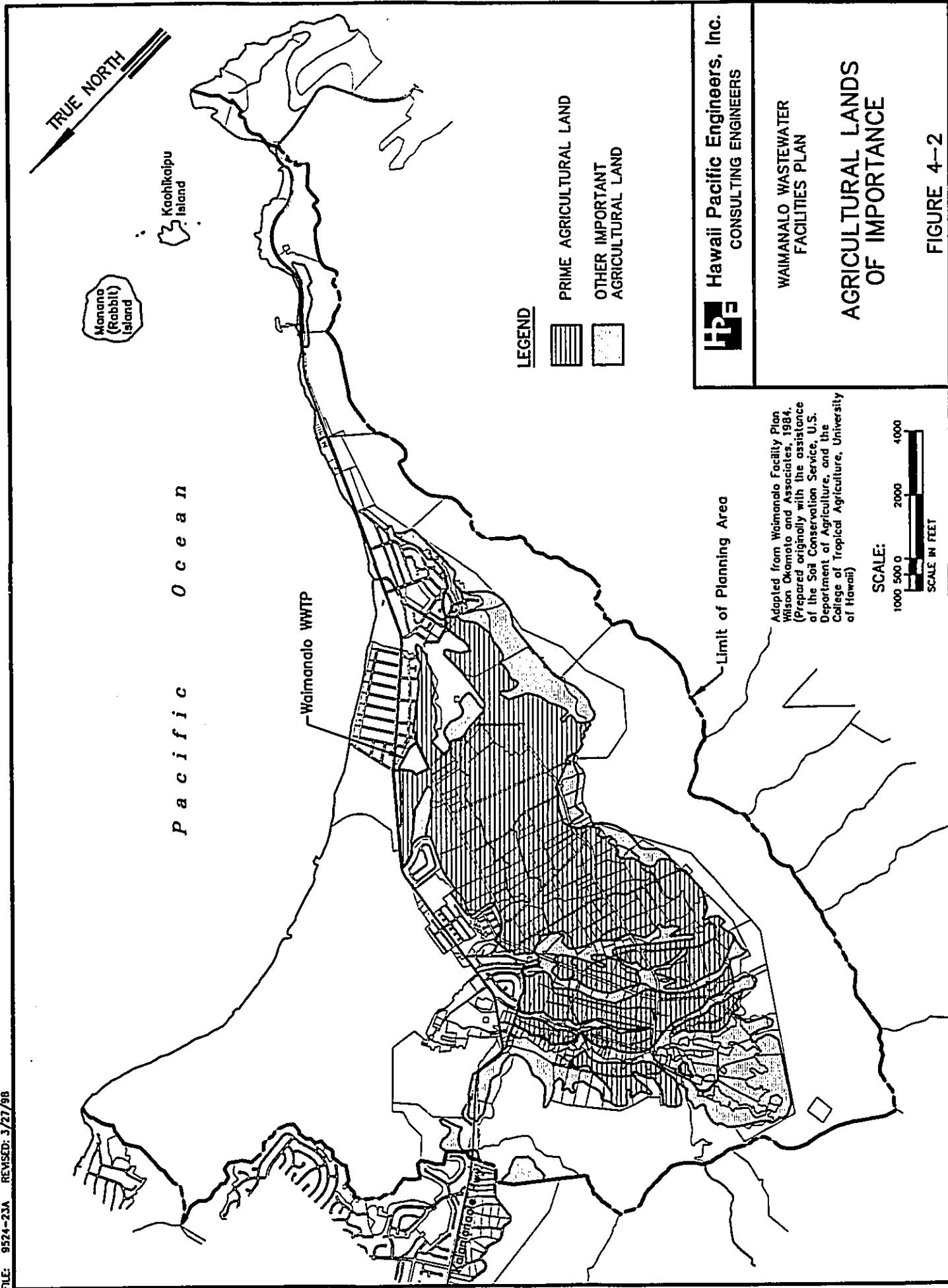

FIGURE 4--2

and residential lands, are classified as Prime and Other Important Agricultural Lands. There are no Unique Agricultural Lands in the area.

The proposed action includes the development of a 3.5 million gallon reclaimed water reservoir by the State Department of Agriculture (DOA) and the National Resource Conservation Service (NRCS; formerly Soil Conservation Service). The reservoir will be located at the existing DOA Wing King Reservoir site (TMK 4-1-26:03) and on a portion of existing State land leased to Unisyn Biowaste Technology (TMK 4-1-26:04). This action was previously addressed in the "Watershed Plan and Environmental Impact Statement, Waimanalo Watershed," prepared by the Soil Conservation Service (U.S. Dept. of Agriculture, 1981). This action will result in use of about three acres of prime agricultural land. The land, however, is currently not used for agricultural production and the availability of reclaimed water during dry periods is anticipated to increase the amount of acreage that can be cultivated.

Coastal Zone Management

The Hawaii Coastal Zone Management (CZM) Program provides goals and objectives to guide the use, protection, and development of land and ocean resources within Hawaii's coastal zone, pursuant to Chapter 205A, Hawaii Revised Statutes. The program is a federally-approved CZM program that is administered by the Office of State Planning.

The CZM objectives and policies address recreation resources, historic resources, scenic and open space resources, coastal ecosystems, economic uses, coastal hazards, managing development, public participation and education, beach protection, and management of marine resources. The relationship of the proposed action to these areas are discussed in various sections of this document. The proposed action is consistent with the objectives and policies of the Hawaii CZM Program. The proposed action, in particular, will promote the protection of Waimanalo Bay's coastal ecosystem and recreational value.

State of Hawaii Department of Health, Water Quality Management Plan for the City and County of Honolulu, (208 Plan)

Section 208 of the Clean Water Act (Public Law 92-500, Federal Water Pollution Control Act, as amended) contains specific requirements for the development and content of the initial water quality management plan. The water quality management document is commonly referred to as the "208 Plan." The initial 208 Plan for Hawaii was developed by DOH in the late 1970's in cooperation with other State and City departments. There are five planning documents, one for the state as a whole, and one for each of the four counties in the state. The State 208 Plan covers the same

topics as the County plans but emphasizes statewide goals, objectives, policies, and programs. The 208 Plan for the City and County of Honolulu was revised under a joint effort between the City and the DOH between 1985 and 1990. The current 208 plan for the City, Water Quality Management Plan for the City and County of Honolulu, is dated September 1990.

The 208 Plan directs implementation of recommended solutions to correct priority point and nonpoint water quality problems. Recommended solutions in the plan were based on evaluation of alternatives with consideration of technical, financial and institutional control measures. The 208 Plan includes discussions on water quality standards, water quality monitoring, and various aspects of water pollution control.

Sewering of the approximately 100 homes in the "Bell Street" area (Waimanalo Sewers, Improvement District 3 and 5) was recommended for sewerage by both the 208 Plan and the 1984 Waimanalo wastewater facilities plan. The project is not included in the current facilities plan recommendations due to the high capital costs (estimated \$60,000 per dwelling) and uncertain public health and water quality benefits. It was concluded that performing required upgrades to the existing individual wastewater systems would be a more cost-effective alternative.

EVALUATION OF CITY LAND USE PLANS AND POLICIES

Oahu General Plan

The Oahu General Plan establishes the City and County of Honolulu's long range objectives and represents its commitment to a desirable and attainable future of the Island of Oahu. The general objectives and policies of Oahu General Plan that are particularly relevant to wastewater facility planning include those pertaining to population, the natural environment, transportation, and utilities.

The General Plan also establishes a long-term goal for population allocation among the various areas of Oahu. Population allocations are assigned in terms of percentages. A range of population growth is established for each Development Plan area. The General Plan identifies the Primary Urban Center (Honolulu) as the major center for growth for Oahu, and Ewa as a Secondary Urban Center. The implication is that windward Oahu is not intended for significant further urbanization.

The proposed action does not promote urban development in Waimanalo and will primarily service existing and planned new residential developments.

Koolaupoko Development Plan

Pursuant to Chapter 226, Hawaii Revised Statutes, each County within the State of Hawaii is required to implement the Hawaii State Plan through the adoption and implementation of a County General Plan. In the case of the City and County of Honolulu, Development Plans (DPs) have been established as a policy "bridge" between the City's General Plan and its zoning powers.

The island of Oahu is divided into eight DP areas. Each DP provides relatively detailed plans for implementing and accomplishing the objectives and policies of the Oahu General Plan for that particular region. The plans establish the desired sequence, patterns, and characteristics of future land uses and public facilities. The Koolaupoko DP spans the area from Kaoio Point at the northern end of Kaneohe Bay to Makapuu Point, and extends inland to the Koolaus. The Waimanalo planning area is a part of the Koolaupoko DP area.

The current DP land use designations for the Waimanalo area is presented on Figure 4-3. The existing DP generally reflects the City's intent to maintain the rural character of Waimanalo. Under the current DP, the existing small, low-density, residential community character will continue to be surrounded by diversified agricultural pursuits.

A public facility map accompanies each DP and shows approximate locations of major planned public facilities. The DP public facilities map designates the existing Waimanalo WWTP for modification (STP/M designation). Under Ordinance 91-54 (July 29, 1991) the Waimanalo Sewers Section 2 Improvement District was added to the DP public facilities map.

The current DP land use map does not incorporate the development plans for future housing by State agencies such as the DHHL and OHA. DHHL and OHA projects are not subject to State and City land use policies and appropriate changes are typically made to the land use planning maps following implementation of the project. In Waimanalo, the potential future developments by these agencies have a significant impact on the projected wastewater infrastructure requirements.

The Koolaupoko DP was adopted in 1983 and amended periodically thereafter. The Koolaupoko DP is currently undergoing a major revision as part of the City's Development Plan Revision Program (C&C of Honolulu Planning Department, 1997). The 1992 amendments to the City Charter changed the definition of the DPs from "relatively detailed plans" to "conceptual schemes." The 1992 City Charter amendments established that the purpose of the DPs is to provide:

DATE: 10/18/96
 SCALE: 1" = 4000'
 FILE: 9524-06A
 RKA
 OPER: SHA, CDK
 REVISED: 4/20/98

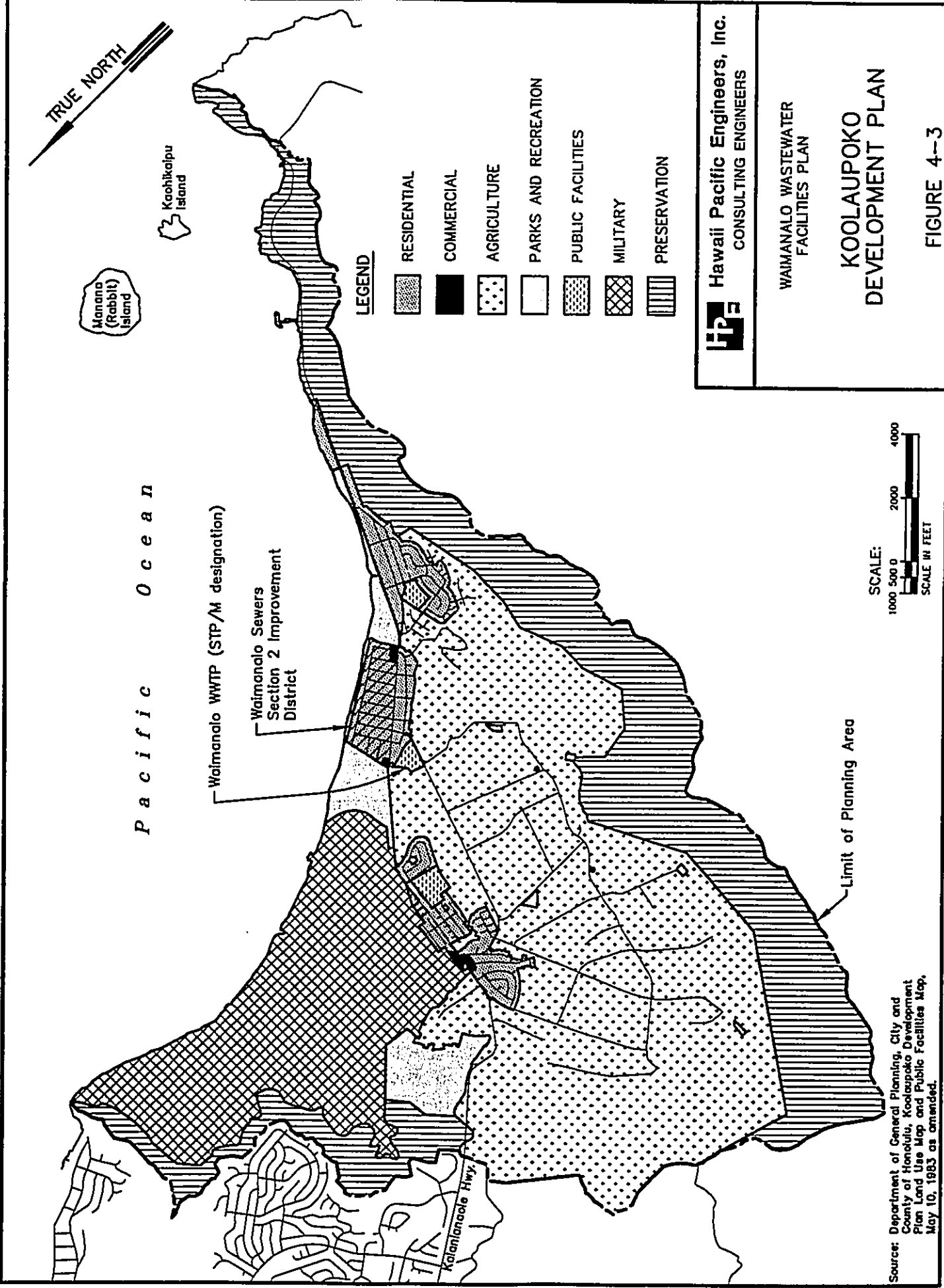

Source: Department of General Planning, City and County of Honolulu, Koolau-poko Development Plan Land Use Map and Public Facilities Map, May 10, 1983 as amended.

HPE Hawaii Pacific Engineers, Inc.
 CONSULTING ENGINEERS

WAIMANALO WASTEWATER FACILITIES PLAN

KOOLAUPOKO DEVELOPMENT PLAN

FIGURE 4--3

- "priorities...(for the) coordination of major development activities"; and
- sufficient description of the "desired urban character and the significant natural, scenic and cultural resources... to serve as a policy for more detailed zoning maps and regulations and public and private sector investment decisions."

Anticipated revisions to the format of the Koolaupoko DP include simplification of the maps to eliminate parcel boundaries and the use of a larger number of maps to show land uses, open spaces and views, community facilities, and detailed "window" maps. The revised DPs are anticipated to provide more substantive guidance in the form of design principles and development phasing guidelines. The revised DP will also include planning policies, principles and guidelines relating to state and federally controlled lands. This will provide state and federal agencies with a better picture of how these areas should fit into the City's long-term vision and plan for the area.

Since draft development strategies for the Koolaupoko DP *are* scheduled to be completed by *December* 1998, the Waimanalo Wastewater Facilities Plan was not able to fully consider the proposed revisions to the DP plan. The prefinal Waimanalo Wastewater Facilities Plan was completed in April of 1997 and completion of the final plan is targeted for fall of 1998 upon completion of the environmental review process.

The findings and recommendations of the Waimanalo Facilities plan are subject to change based on any major revisions to the Koolaupoko Development Plan and other factors that may significantly affect future development. Adjustments can be made to treatment unit capacities during the preliminary engineering and design phases of the project where required and justified based on additional information that may become available. Planning of wastewater facilities is an ongoing dynamic process which requires the consideration of the latest available information and technology. The facilities plan is only intended to only serve as a general planning tool.

Unless the character of rural/agricultural character of Waimanalo is changed by the Koolaupoko DP revisions, major modifications to the facilities plan are not anticipated to be required. The facilities plan population projections are generally consistent with City Planning Department estimates and current planning objectives for the region. Much of the future increase in population in Waimanalo is anticipated to be due to additional development by DHHL. An attempt was made to fully accommodate DHHL's future planned developments in the facilities plan, including possible development of the surplus Bellows AFS land.

Zoning

The City Land Use Ordinance is found in Chapter 21 of the Revised Ordinances of Honolulu. The stated purpose of the Land Use Ordinance is to regulate land use in a manner that will encourage orderly development in accordance with adopted land use policies, including the Oahu General Plan and Development Plans, and to promote and protect the public health, safety and welfare. The Land Use Ordinance is administered by the City Department of Planning and Permitting.

City zoning designations under the Land Use Ordinance provides standards for building densities, structure types, and the use of structures and land parcels. Figure 4-4 shows the zoning designations for the Waimanalo area. The estimated acreage for each zoning designation within the Waimanalo area was obtained from the City's Geographical Information System (GIS) and are listed in Table 4-2.

Approximately 41 percent of the 7,093 acre Waimanalo planning area is zoned for agricultural use. Preservation lands account for another 33 percent of the area. Approximately 6 percent of the Waimanalo planning area is zoned for residential purposes. This proportion of residential area is low because Bellows AFS and Olomana Golf Links are included in the overall total area.

Existing zoning in Waimanalo is not entirely consistent with the Koolaupoko Development Plan. The zoning map shows slightly more residential designated area than the DP map. The DP states that all zoning is to be brought into conformance with the DP map within a reasonable amount of time.

The Waimanalo WWTP site is currently zoned AG-1 (Restricted Agriculture). The wastewater treatment facility is classified as a "Type B utility installation" due to its potential major impact. The City Department of Planning and Permitting indicated that a Conditional Use approval, which would normally be required for Type B utility installation on AG-1 land, is not required due to operation of the facility by the City.

Special Management Area

The Special Management Area (SMA) has been designated to control development along the shoreline. Generally, the SMA includes lands extending not less than 100 yards inland from the upper reaches of the wash of the waves, and any additional areas designated by each County. Improvements within the SMA generally require an SMA permit from the City and County of Honolulu, Department of Planning and Permitting. The SMA boundary along the Waimanalo coast is delineated in Figure 4-4. The SMA boundary is also shown on larger scale plans on Figures 1-2a and 1-2b back in Chapter 1.

DATE: 10/18/96
 SCALE: 1" = 4000'
 FILE: 9524-07A

RKA
 OPER: SHA*CDK
 REVISED: 4/20/98

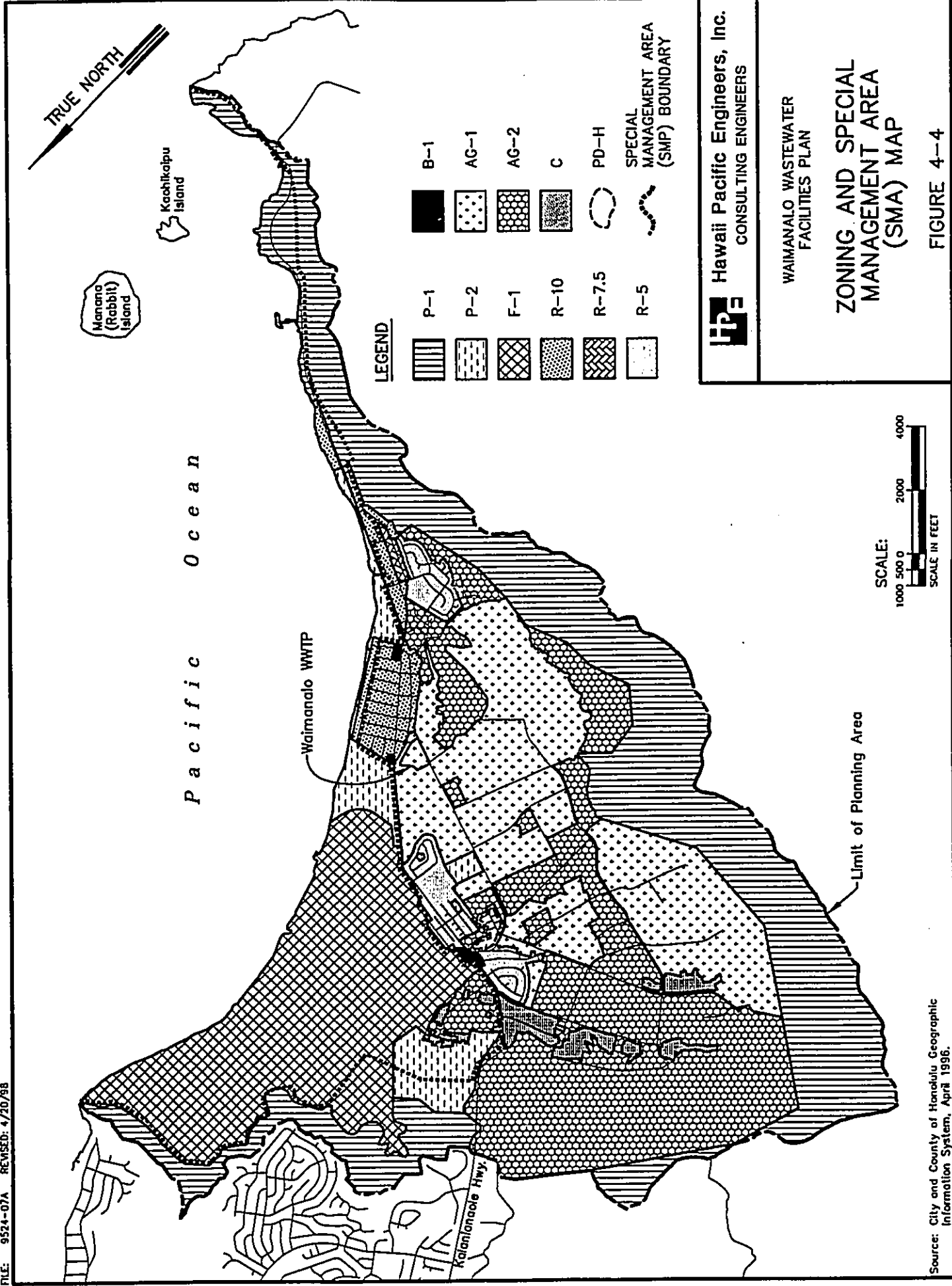

HPE Hawaii Pacific Engineers, Inc.
 CONSULTING ENGINEERS

WAIMANALO WASTEWATER
 FACILITIES PLAN

**ZONING AND SPECIAL
 MANAGEMENT AREA
 (SMA) MAP**

FIGURE 4-4

**TABLE 4-2
PLANNING AREA ZONING**

ZONING CLASSIFICATION	AREA (acres)
P-1 (Restricted Preservation) ¹	2,054
P-2 (General Preservation) ²	284
F-1 (Military and Federal) ³	1,261
R-10 (Residential) ⁴	198
R-7.5 (Residential) ⁴	13
R-5 (Residential) ⁴	219
B-1 (Neighborhood Business) ⁵	8
AG-1 (Restricted Agriculture) ⁶	1,293
AG-2 (General Agriculture) ⁶	1,640
C (Country) ⁷	123
PD-H (Planned Development Housing) (R-5) ⁸	20
TOTAL	7,093

Notes:

1. The P-1 designation includes all land within a State-designated conservation district. All uses, structures, and development standards are governed by the appropriate State agency.
2. Within the P-2 district, uses, structures and development standards are defined for aquaculture, cemeteries, crop production, forestry, game preserves, golf courses, livestock grazing, public use and structures, telecommunications structures, and utility installations.
3. Within a F-1 district, all military and federal uses are permitted.
4. Minimum lot areas in an R-10, R-7.5 and R-5 districts are 10,000, 7,500, and 5,000 square feet, respectively. Requirements are defined for lot width and depth, yards, maximum building area (50%), and building heights.
5. Within a B-1 district uses, structures and development standards are defined for a variety of business uses. Minimum lot size is 5,000 square feet.
6. The minimum land area for AG-1 and AG-2 districts is 15 and 6 contiguous acres, respectively. The maximum number of farm dwellings in AG-1 and AG-2 districts must not exceed 1 unit per 5 acres and 1 unit per 2 acres, respectively. The maximum number of multifamily dwellings shall not exceed 4 dwelling units in any structure for either designation.
7. The minimum land area for county districts is 3 contiguous acres. The maximum number of dwellings is one per acre. The maximum number of multifamily dwellings shall not exceed four dwelling units.
8. The PD option is intended for higher density residential housing on large parcels of vacant land or parcels being redeveloped while completing the surrounding neighborhood. For R-5 the minimum land area is 1 acre.

The Waimanalo WWTP is not situated within the SMA. Only the Kahawai Stream WWPS and a narrow strip of the Waimanalo Sewer Improvement District No. 2 nearest the coast line are in the SMA (see Figures 1-2a and 1-2b). If the Beach Lot area is sewerred in the future, an SMA use permit will be required.

EVALUATION OF FEDERAL LAND USE PLANS AND POLICIES

Federal land is not directly subject to state and county land use regulations but is indirectly subject to the Coastal Zone Management's regulatory process administered by the State of Hawaii. *Federal land in Waimanalo primarily consists of the Bellows Air Force Station (AFS). The Bellows AFS is the property of the 15th Air Base Wing (ABW) at Hickam Air Force Base. The Navy has been granted a permit by the Air Force that allows the Marine Corps to train in designated areas at Bellows AFS.*

The Bellows AFS is currently used primarily for periodic amphibious military maneuvers. Along portions of the beach fronting the station, amphibious vehicle landings, use of tracked vehicles, parachute drops, and other similar activities have been conducted as military training exercises.

Future development plans for the Bellows AFS were developed *for the Commander in Chief, U.S. Pacific Command (USCINCPAC)*, and documented in the Final Environmental Impact Statement, Land Use and Development Plan Bellows Air Force Station, Waimanalo, Hawaii, (1995). The future plans for the Bellow AFS land were previously discussed in Chapter 3. Major projects include a Hawaii Army National Guard training site and possible housing development by DHHL. The construction of military residential housing is not proposed for the Bellows AFS land. The wastewater infrastructure proposed in the Waimanalo Wastewater Facilities Plan is consistent with the proposed planned developments at Bellows AFS.

SUMMARY OF REQUIRED APPROVALS

Permits and approvals which are anticipated to be required for construction and operation of the proposed facilities are as follows:

State Permits/Approvals

Construction plan approvals	Department of Health, Department of Transportation
Engineering reports and submittals for reclamation facilities	Department of Health
Engineering reports and submittals for water reclamation reuse projects	Department of Health

State Permits/Approvals

Underground Injection Control (UIC) permit	Department of Health
<i>NPDES permit (construction dewatering and storm water runoff from a construction site)</i>	Department of Health
Community noise permit	Department of Health
Permit to perform work upon a State highway	Department of Transportation

City and County of Honolulu Permits/Approvals

Construction plan approvals	Department of Design & Construction
Building permit for building, electrical, plumbing, sidewalk/driveway, and demolition work	Department of Planning & Permitting
Grubbing, grading and stockpiling permit	Department of Planning & Permitting
Permit to excavate public right-of-way (trenching)	Department of Planning & Permitting
Street usage permit	Department of Planning & Permitting
Construction dewatering permit (temporary)	Department of Planning & Permitting
Permit to discharge effluent (temporary)	<i>Department of Environmental Services</i>
Special Management Area Use Permit	Department of Planning & Permitting
Flood hazard variance	Department of Planning & Permitting
Flammable and combustible liquids-tank installation	Honolulu Fire Department

None of the permit applications listed above have been prepared and submitted to date. Most of the approvals will be required during subsequent preliminary engineering, design and construction phases.

Completion of the environmental review process for the Waimanalo Wastewater Facilities Plan will satisfy the requirements of Chapter 343, Hawaii Revised Statutes.

Completion of the process will permit the City or State to qualify for State Revolving Funds for construction of the improvements. To meet Federal funding requirements, an EIS addressing the proposed reclaimed water reservoir, pumping facilities, force main, distribution system and other appurtenances was prepared by U.S. Department of Agriculture Soil Conservation Service in 1981.

1
2
3
4
5
6
7
8
9
10
11
12
13
14
15
16
17
18
19
20
21
22
23
24
25
26
27
28
29
30
31
32
33
34
35
36
37
38
39
40
41
42
43
44
45
46
47
48
49
50
51
52
53
54
55
56
57
58
59
60
61
62
63
64
65
66
67
68
69
70
71
72
73
74
75
76
77
78
79
80
81
82
83
84
85
86
87
88
89
90
91
92
93
94
95
96
97
98
99
100

Chapter 5

Probable Impacts and Mitigation Measures

CHAPTER 5

PROBABLE IMPACTS AND MITIGATION MEASURES

INTRODUCTION

This chapter describes probable impacts on the natural and human environment from the proposed expansion and upgrade of wastewater facilities in Waimanalo, and the proposed mitigation measures. The proposed action will have a wide range of impacts. The impacts will range from those that are direct and short term to those that are indirect or long term. There are also cumulative impacts that may need to be considered in relation to other related projects and existing conditions. Some of the impacts are beneficial to the environment whereas others are adverse. Although some of the adverse impacts are unavoidable, mitigation measures can be implemented to minimize the extent of the undesirable consequences.

The following discussions address the long and short term impacts of the proposed action. For the purpose of qualifying for funds from the State Revolving Fund (SRF) loan program administered by the State of Hawaii Department of Health, impacts relative to Federal "cross-cutting" authorities are addressed at the end of the chapter.

LONG TERM IMPACTS

Water Quality and Public Health Protection

1. General

Clean coastal waters in Waimanalo are important for meeting the increased recreational demands of the growing resident population. In Hawaii's tourist-based economy, it is important for Waimanalo's coastal waters to also meet the recreational needs and expectations of the visitor population.

Riparian and coastal waters can be impacted by a wide range of pollutants and by various means. Wastes and other pollutants disposed on land may enter surface water bodies directly via surface runoff or through subsurface seepage via groundwater. Similarly, groundwater contaminated through subsurface disposal of wastes ultimately impacts surface waters when the groundwater enters the surface water bodies. Certain pollutants may enter surface water bodies directly via such sources as wastewater outfalls, swimmers and boaters.

Pollutants typically originate from human activities on land and water, but may also result from natural sources.

Based on the discussions presented in Chapter 3, it can be concluded that Waimanalo is faced with significant water quality concerns. The origin and fate of pollution in streams and nearshore waters, however, is complex and not well documented. It appears that aquatic pollution in the study area cannot be readily attributed to a single source. High nutrient loading, primarily in the form of nitrogen compounds, and the associated occurrence of algal blooms in Waimanalo's coastal waters appear to be the most significant concern. Data from a State of Hawaii Department of Health (DOH) shoreline monitoring station near the mouth of Waimanalo Stream indicates noncompliance with state open coastal receiving water quality standards for nitrogen and chlorophyll *a*.

The following discussions address the water quality and public health impacts of the various pollution sources in Waimanalo and the ramifications of the proposed action. The discussions primarily focus on the following three sewage-related potential sources of pollution and public health concerns addressed by the Waimanalo Wastewater Facilities Plan:

- Wastewater collection system (i.e., sewers and sewage pumping facilities),
- Waimanalo Wastewater Treatment Plant (WWTP), and
- Individual wastewater systems

Non-point and other sources of pollution are also briefly discussed. Mitigation of water pollution in Waimanalo will require considerable expenditure of time, effort and funds, and therefore the control and management of other pollution sources should also be considered.

2. Wastewater Collection System

The water quality and public health concerns associated with the wastewater collection system primarily stem from spillage of raw wastewater from the system into streets, yards, and drainage systems. Backup and overflows within a home may also potentially occur in certain cases. Spills from the wastewater collection system may result from:

- Heavy flows during rainy weather (due to infiltration and inflow of rainwater into the sewers),
- Line blockages,
- Breaks in sewer lines and force mains, and

- Mechanical malfunctions at wastewater pump stations.

Spills from the collection system are generally infrequent and of relatively short duration. These spills, however, involve raw untreated sewage and are most likely to occur during heavy rains when the coastal waters are heavily stressed from other sources of pollutants.

Spills from the Waimanalo collection system have not been a major problem in the past. Based on the City Department of Environmental Services records and the Spill Reduction Action Plan (SRAP) study (C&C of Honolulu Dept. of Wastewater Management, 1996), during a three-year period from 1990 to 1993, there were nine wastewater spills. Based on another SRAP study, (R.M. Towill, 1995), there have been no observed spills associated at the Kahawai Stream Wastewater Pump Station (WWPS) during a five-year period extending from 1989 through 1993. Based on available spill record information and discussions with collection system maintenance personnel, most if not all the spills appear to be due to obstructions such as grease, tree roots, and debris, and not due to insufficient system capacity. The City is currently instituting improved collection system maintenance programs to minimize sewage spills due to blockages.

Although there is a lack of documented spills due to sewer capacity limitations, flow monitoring records do indicate high wet weather flows in one section of the sewer system located upstream of the Kahawai Stream WWPS. The high wet weather flows which are due to excessive infiltration and inflow have resulted in degradation of treatment performance and injection well spills at the Waimanalo WWTP.

The proposed rehabilitation of the sewers as part of the proposed action is expected to significantly reduce wet-weather infiltration and inflow of extraneous rainwater into the wastewater system. With the rehabilitation, the projected year 2020 design peak wet-weather flow at the Waimanalo WWTP is projected to be reduced from approximately 6.8 million gallons per day (mgd) to 4.8 mgd. This will reduce the probability of spillage of untreated sewage from the wastewater collection system and the Waimanalo WWTP during extreme rainfall events and thereby improve the level of water quality and public health protection. The reduction in peak wet weather flows will also improve the performance of the Waimanalo WWTP during the high flow periods and reduce the extent of capital improvements required at the plant.

3. Waimanalo Wastewater Treatment Plant

The Waimanalo Wastewater Treatment Plant (WWTP) injects treated wastewater consisting of disinfected secondary effluent deep into the permeable calcareous aquifer. At present, the average flow at the plant is approximately 0.6 mgd. Proposed expansion of the wastewater collection system is expected to increase the average daily flow to as high as 1.1 mgd by year 2020.

The Waimanalo community has expressed concerns regarding the performance and reliability of the Waimanalo WWTP and the practice of injecting treated effluent into the groundwater aquifer. These concerns are well founded since wastewater effluent is potentially a source of human pathogens and biostimulatory nutrients, and treated effluent injected into the subsurface aquifer will eventually find its way to coastal waters. The Waimanalo WWTP has a history of capacity and operating problems. Inadequate injection well capacity in the past has led to wastewater spills into the adjacent drainage ditch during peak wet-weather flows. The Waimanalo WWTP employs outdated liquid stream treatment technology. This has resulted in problems with unstable operations, which in turn causes high suspended solids concentrations in the effluent and accelerated clogging of the disposal wells. Environmental impacts and public safety hazards related to the use of chlorine gas for disinfection and the future use of reclaimed water for irrigation are also potential concerns to the community.

The following discussions address the impacts, concerns, and mitigating factors associated with the Waimanalo WWTP.

a. Microbial Contaminants from Discharge of Treated Effluent

The extent of potential impacts from the subsurface discharge of microbial contaminants by Waimanalo WWTP injection wells is influenced by many factors. Some of the factors include the initial concentration of effluent's microbial contaminants, travel time of the effluent to coastal waters, extent of dispersion and dilution in the aquifer, and entry location/depth in the coastal waters.

The geology of the Waimanalo area fortunately tends to mitigate the adverse impacts associated with the effluent injection practice. The Waimanalo WWTP injects the effluent into the deep porous coral stratum at depths between 70 and 200 feet. The low salinity effluent would have a tendency to rise and "float" on the saline water table. A low permeability alluvium stratum above the coral stratum, however, is believed to minimize

"surfacing" of the lower density wastewater effluent in nearshore areas (see discussions on geology and Figure 3-5 in Chapter 3).

The extent of the alluvium stratum extending into the ocean, however, is unknown based on available information from geologic studies. Also, discussions with local researchers (Fletcher and Sherman, 1997) indicate that there are outcrops of the "older" (lower) coral and limestone formations in the nearshore region of Waimanalo Bay. These potentially permeable formations may or may not be resulting in transmission of diluted treated effluent from the lower geologic formations into the nearshore waters.

The effectiveness of the filtering action of the older coral formations, recent coral growths, and alluvial and sandy substratum in Waimanalo is uncertain. The decrease in wastewater pathogens due to the effects of dilution, dieoff with passage of time (outside the host), predation by other microbes, and exposure to saline water, however, would be expected to be significant. As indicated in Chapter 3, streams and surface runoff appear to be the major source of microbiological contaminants in Waimanalo Bay, particularly during rainy weather. Researchers have indicated that contamination from the use of injection wells in Hawaii have not been a significant problem in the past (Oberdorfer and Peterson, 1982).

Regulatory requirements and past actions of DOH generally support the conclusion that microbiological contaminants are not of significant concern with the Waimanalo WWTP injection well discharges. To date, the DOH has not imposed stringent microbiological limitations on effluent disposed of in injection wells. Currently, the DOH Chapter 62 wastewater regulations only require a 0.1 mg/l chlorine residual which corresponds to a minimal level of disinfection. DOH officials have indicated that the requirement for maintaining a chlorine residual in effluent discharged to injection well systems will most likely be eliminated under the proposed revisions to its Chapter 62 regulations. The Underground Injection Control (UIC) permit for the Waimanalo WWTP currently has no effluent limits for microbiological contaminants.

The current practice is to chlorinate the Waimanalo WWTP effluent at all times. Disinfection of the effluent, along with the other treatment processes, can significantly reduce the level of microbial contaminants to the extent necessary to mitigate public health concerns. Microbiological monitoring data for the Waimanalo WWTP effluent (September 1995 through August 1996) indicate an average (geometric mean) fecal coliform concentration of 3,200 CFU/100 mL (five samples with a range of 77 to 48,000 CFU/100

mL). The concentration of fecal coliform is higher than would be expected for a chlorinated secondary effluent. This may be due to the unstable performance of the plant. In comparison, however, raw sewage typically has coliform concentrations on the order of 10^6 to 10^7 CFU/100 mL (M&E, 1991). Hoover, et al. (1997) report fecal coliform levels on the order of 800,000 and 17,000,000 CFU/100 mL for cesspools and Sand Island WWTP primary effluent, respectively.

Under the proposed plan for future use of treated effluent for irrigation, upgraded treatment and disinfection facilities would be installed to allow production of a highly disinfected effluent. The new disinfection facilities are primarily intended to be used to provide a high level of disinfection for the reclaimed water used for irrigation. The disinfection facilities, however, could also be used to provide an appropriate level of disinfection for effluent disposed of in the injection wells.

From a public health standpoint, the proposed reuse of "R-1" quality reclaimed water from the Waimanalo WWTP for crop and golf course irrigation should not contribute to any adverse impacts to the community, cumulative or otherwise. Due to extremely high standards imposed by the DOH on R-1 reclaimed water, any adverse impacts on public health are expected to be negligible. A high level of effluent disinfection through the use of "state-of-the-art" ultraviolet (UV) technology is proposed. The disinfection facilities would be required to produce effluent that is essentially free of fecal coliform to ensure that the effluent is free of pathogens. The effluent would be nearly equivalent to potable water with respect to microbiological contaminant quality. Continuous monitoring of the effluent quality (turbidity) will be required to help ensure adequate disinfection and very low levels of microbiological contaminants. If the effluent fails to meet the required quality, the system would be designed to automatically divert the effluent to the injection well system for disposal. The direct application of treated effluent on edible portions of crops is not being proposed to provide an even greater margin of public health safety.

b. Nutrients from Discharge of Treated Effluent

Based on the high algal concentrations in the nearshore waters in Waimanalo Bay, nutrients from the treatment plant effluent are of greater concern than microbiological contaminants. Among the two key nutrients, nitrogen and phosphorous, nitrogen would be of greater concern.

Unlike nitrogen, phosphorus is unlikely to be transported effectively by groundwater. Oxidation of organic material ultimately results in the production of phosphate, which is strongly adsorbed to particle surfaces, particularly particles containing iron oxy-hydroxides and/or carbonate. Iron oxy-hydroxides are likely to be common in watershed soils and carbonates dominate subsoils in the coastal areas (Hoover, et al., 1997).

Total Waimanalo WWTP effluent nitrogen (total Kjeldahl+nitrate-nitrite nitrogen) concentration has averaged approximately 10 mg/L, which translates to a mass emission on the order of 50 lb/day. The current plant operating practices produce fairly substantial nitrogen removal. The removal of nitrogen, however, is inconsistent and is primarily a consequence of attempts to control other operating parameters.

The significance of the current mass emission of nitrogen from the Waimanalo WWTP is uncertain. As discussed below, there are many other sources of nitrogen that may be impacting the coastal waters of Waimanalo. Individual wastewater systems in Waimanalo, based on a user population of 4,100 and a typical per capita generation rate of 0.031 lb/day (Sunn, Low, Tom and Hara, 1971), would generate on the order of 130 lb/day of total nitrogen.

The concentration of nitrogen in wastewater is fairly significant relative to marine water quality standards. One gallon of treated wastewater (with about 20 mg/L-N of nitrates), would need to be diluted by about 5,700 gallons of nitrate-free water to comply with the State's "dry" geometric mean coastal water criteria of 3.5 μ g/L. High levels of dilution, however, would be expected to be achieved within the subsurface aquifer receiving the effluent and in the offshore coastal waters. Nitrogen from cesspools and other individual wastewater systems located in the coastal areas would generally be of greater concern due to the propensity of the nitrogen to enter the shallow coastal waters.

The location of the discharge of wastewater effluent into receiving waters will influence whether the discharge has an adverse impact, no impact or even a beneficial impact. The East Mamala Wastewater Facilities Plan EIS (Belt Collins Hawaii, 1993) noted that a study by Hyperion Engineers for three wastewater outfalls in California, the presence or absence of an outfall appeared to have no bearing on the level of plankton in the marine waters. The EIS also indicated that offshore oligotrophic (nutrient poor) waters such as those found in Hawaii can assimilate large quantities of nutrients and may

in some cases experience a beneficial effect. This beneficial effect would be to increase food organisms for fish and other marine life.

In the case of Waimanalo, the adverse impacts of nutrients from the Waimanalo WWTP *may or may not be significant*. Based on Waimanalo's geology, it is anticipated that most of the effluent would enter the ocean beyond the shallow bathing waters and coral reef zone where excessive nutrients are of most concern. *The general locations of significant discharges of wastewater effluent into coastal waters and any associated potential adverse impact to the ecosystem should be evaluated in further detail* through additional investigations. Some of the investigation methods that might be considered include:

- Water quality sampling (suspected impacted locations and control stations);
- Infrared scanning aerial photography (to detect cooler groundwater discharges);
- Nitrogen or boron isotope tracing (isotopes for wastewater differ from other pollution sources);
- Dye injection/tracing (using a fluorometer for quantitative dye concentration analysis); and
- Benthic surveys of marine biology (biology of areas with concentrated freshwater discharges are likely to be different).

The primary purpose of the investigations would be to detect any major subsurface conduits within the nearshore geology which result in discharges to shallow waters (i.e., less than 30 feet deep). The investigations may be integrated with those for evaluating discharges from the individual wastewater systems.

Despite the *unknown* impact of nutrients from the Waimanalo WWTP, the capability to remove nitrogen is proposed for the future plant expansion. As indicated in Chapter 2, with available state-of-the-art technology, the consistent reduction of nitrogen in the effluent at Waimanalo is cost-effective. The proposed anoxic-aerobic activated sludge nutrient removal process recommended for the Waimanalo WWTP will offer the benefits of excellent performance and process stability in addition to nitrogen removal at minimal additional capital and operating costs. The upgraded treatment facilities *are* expected to produce effluent with total nitrogen concentrations

generally less than 8 mg/L-N . At a 1.1 mgd average flow and 8 mg/L-N total nitrogen concentration, the mass emission of nitrogen would be approximately 73 lbs/day. The amount of nitrogen discharged by the plant will only slightly higher than current levels despite substantially increased flow. The 8 mg/l nitrogen concentration may in some cases be actually lower than the concentration of the existing groundwater being discharged into Waimanalo Bay. The proposed action would also potentially eliminate as many as 540 individual systems¹ which would reduce nitrogen loading on nearshore coastal waters by approximately 68 lbs/day.

Removal of nitrogen from the wastewater will also benefit future reuse of the effluent. As noted in Chapter 2, agricultural users generally prefer irrigation water low in nutrients due to the need to control the level and timing of fertilizer application. Crops and turf irrigated with reclaimed water will utilize nutrients in the applied wastewater which will further reduce nutrient loading on coastal waters.

The impact of nutrients from the use of reclaimed water on groundwater and coastal water quality is expected to be negligible. Based on the estimated use of 0.31 mgd of reclaimed water having an average total nitrogen concentration of 8 mg/L-N , the total nitrogen loading on the groundwater would be approximately 21 lb/day. Uptake of nitrogen by the irrigated crops or turf and denitrification occurring in the soil would likely reduce the amount of nitrates actually reaching the water table. The Honolulu Board of Water Supply is anticipated to restrict the use of reclaimed water to areas below the "no pass" line to eliminate concerns with contamination of the potable water supply. The acreage of land irrigated with reclaimed water above the "no pass" line, if allowed, would be minimal and the concentration of the applied reclaimed water would be below the potable water Maximum Contaminant Level (MCL) of 10 mg/L-N for nitrates.

c. Wastewater Treatment Plant Wastewater Spills and Hydraulic Capacity

Spills associated with overflow of the Waimanalo WWTP injection wells during high wet-weather flows are a concern from both a public health and water quality standpoint. Such occurrences can be regarded as being highly undesirable without an extensive analysis of actual public health risks and water quality impacts.

¹Approximately 350 homes in Sewer Improvement District No. 2 and about 190 homes in sewer areas still served by individual wastewater systems.

Based on the "Spill Response Action Plan (SRAP) Engineering Report," (R.M. Towill, 1995), there were twelve spills during the five-year review period extending from 1989 through 1993. Two spills were attributed to maintenance/construction activities. The remainder of the spills were attributed to high wet-weather flows. The spills ranged in size from 300 gallons to 826,000 gallons.

The occurrence and risk of spills from the injection wells have been significantly reduced due to the construction of three new injection wells in 1994. However, high flows during wet weather due to infiltration and inflow of rainwater into the sewers, and injection well clogging problems due to periodic episodes of poor effluent quality, remain a concern. The proposed rehabilitation of sewers to reduce sewer infiltration and inflow, and treatment facility upgrade work to install more injection wells and improve capacity, performance and reliability, will significantly reduce or even eliminate the occurrence of spills at the plant.

d. Effluent Disinfection

The proposed use of ultraviolet (UV) disinfection under the proposed *upgrade* will have the beneficial impact of eliminating the possibility of accidental release of toxic chlorine gas. Chlorine gas is highly toxic and accidental release of chlorine gas is a safety concern to both plant personnel and the surrounding community. UV disinfection has the significant benefit of having minimal safety concerns.

Future chlorine use at Waimanalo WWTP will likely be limited to periodic addition of *sodium* hypochlorite solution (bleach) to the wastewater to reduce foaming and to control the slime growth that cause *injection* well clogging. The hypochlorite solution, although a strong oxidant, would not have the significant safety concerns associated with chlorine gas. The toxicity of the chlorine solution on marine life and formation of halogenated organic compounds is not a concern due to the low quantities of chlorine used.

e. Effluent Reuse

Future reuse of the effluent will transform the treated wastewater from a potential liability to the environment to a valuable resource. The reuse of effluent, which is projected to potentially average 0.35 mgd, will have beneficial long term benefits. These benefits include conservation of potable water resources, beneficial recycling of nutrients, and increased agricultural production in Waimanalo without development and use of additional irrigation

water sources. As discussed earlier, effluent reuse is not anticipated to have any adverse impacts to public health *or groundwater quality*.

f. Other Waimanalo WWTP Pollution Concerns

The Waimanalo WWTP is an industrial type operation in which mechanical equipment is used to process the wastewater. The facility requires the use of various lubricants, solvents, fuel, cleaning chemicals, and other products which may be considered potential pollutants. The City Department of Environmental Services has extensive Standard Operating Procedures (SOPs) as part of a Best Management Program (BMP) to minimize the potential discharge of contaminants into the onsite and offsite environment. The SOPs include procedures for disposing of used lubricants, use of proper storage facilities with spill containment features, and proper cleanup of accidental spills. New above or below ground fuel storage facilities for expanded standby power generation facilities will be provided with secondary containment, leak detection and other spill prevention features in accordance with applicable regulations.

4. Individual Onsite Wastewater Systems

A potentially significant source of anthropogenic pollutants in the Waimanalo planning area are individual wastewater treatment systems such as cesspool and septic tank disposal systems. These systems, particularly those located near the coastline, have the potential to contribute to the microbiological and nutrient pollutant loads on nearshore waters.

Cesspools in particular, have been regarded by the State of Hawaii Department of Health (DOH) as a key source of groundwater and coastal water pollution (see Chapter 3). DOH also regards individual wastewater systems as a public health hazard in instances where wastewater spillage occurs as a result of hydraulic overloading of the system.

The impacts of individual wastewater systems and possible mitigation measures are discussed below.

a. Public Health Concerns Related to Impacts on Drinking Water

Contamination of drinking water supplies by individual wastewater systems has been a concern in Waimanalo. The Waimanalo Well No. 1, one of three Honolulu Board of Water Supply (BWS) wells in Waimanalo, is currently not in use due to high nitrate levels and contamination by a herbicide known as alachlor. Nitrate levels near the 10 mg/L-N maximum contaminant level

water sources. As discussed earlier, effluent reuse is not anticipated to have any adverse impacts to public health *or groundwater quality*.

f. Other Waimanalo WWTP Pollution Concerns

The Waimanalo WWTP is an industrial type operation in which mechanical equipment is used to process the wastewater. The facility requires the use of various lubricants, solvents, fuel, cleaning chemicals, and other products which may be considered potential pollutants. The City Department of Environmental Services has extensive Standard Operating Procedures (SOPs) as part of a Best Management Program (BMP) to minimize the potential discharge of contaminants into the onsite and offsite environment. The SOPs include procedures for disposing of used lubricants, use of proper storage facilities with spill containment features, and proper cleanup of accidental spills. New above or below ground fuel storage facilities for expanded standby power generation facilities will be provided with secondary containment, leak detection and other spill prevention features in accordance with applicable regulations.

4. Individual Onsite Wastewater Systems

A potentially significant source of anthropogenic pollutants in the Waimanalo planning area are individual wastewater treatment systems such as cesspool and septic tank disposal systems. These systems, particularly those located near the coastline, have the potential to contribute to the microbiological and nutrient pollutant loads on nearshore waters.

Cesspools in particular, have been regarded by the State of Hawaii Department of Health (DOH) as a key source of groundwater and coastal water pollution (see Chapter 3). DOH also regards individual wastewater systems as a public health hazard in instances where wastewater spillage occurs as a result of hydraulic overloading of the system.

The impacts of individual wastewater systems and possible mitigation measures are discussed below.

a. Public Health Concerns Related to Impacts on Drinking Water

Contamination of drinking water supplies by individual wastewater systems has been a concern in Waimanalo. The Waimanalo Well No. 1, one of three Honolulu Board of Water Supply (BWS) wells in Waimanalo, is currently not in use due to high nitrate levels and contamination by a herbicide known asalachlor. Nitrate levels near the 10 mg/L-N maximum contaminant level

(MCL) established by the Safe Drinking Water Act have been reported in the affected well. The 208 Plan (C&C of Honolulu, 1990) indicates that there may be cesspools within approximately 100 feet of the well. It is uncertain whether the high nitrate levels are due to contributions of individual wastewater systems or agricultural sources. The detection of a herbicide in the well indicates that agricultural sources are a factor.

Currently, the City is not tasked to provide sewer service in agricultural areas. Due to the large size of the lots and low population density, the use of centralized wastewater collection and treatment systems would not be cost-effective for the agricultural lots in Waimanalo, particularly for the small number of parcels that may be impacting the BWS well. In general, groundwater flow from the inland basalt basal aquifer would tend to move contaminants in the seaward direction and away from the inland potable water supply wells. If reactivation of the Waimanalo Well No. II is required in the future, it is recommended that a detailed investigation be conducted to determine the cause of the high nitrate levels in the wells. If necessary, individual wastewater systems can be designed to reduce the discharge of nitrates. The threat of contamination from herbicides and fertilizers, however, would still remain. Another alternative would be to treat the water to remove the contaminants. The BWS currently has plans to place its new well, Waimanalo Well No. III, into production in the near future to replace the contaminated well. The cost-effectiveness of treating the water from Waimanalo Well No. II may be investigated in the future if the demand for additional potable water arises.

There have been no known occurrences of microbiological contamination of potable water wells in Waimanalo. The microbial contaminants from individual wastewater systems and/or other sources are most likely being removed as the water infiltrates through the relatively "tight" soil stratum typical of the inland areas of Waimanalo.

b. Public Health Concerns Related to Subsurface Discharges to Recreational Waters

The potential public health impacts from microbiological contamination of recreational waters from subsurface leachates generated by individual wastewater systems in Waimanalo appear to be relatively insignificant. This tentative conclusion is based on literature research and limited field data. This issue is addressed in the discussions presented below on coastal water quality impacts.

c. Public Health Concerns Related to Spills from Failing Systems

Individual wastewater systems may pose significant public health concerns as a result of spills and overflows from failing systems. Spills from cesspools and septic tank soil absorption systems may result from one or more factors which cause the infiltrative and storage capacity of the system to be exceeded. These factors include:

- Inadequate sizing of the system with respect to soil and groundwater conditions,
- Location of systems in moisture sensitive expansive soils which are characterized by low permeability even under ideal conditions (i.e., no groundwater or rain) ,
- Excessive hydraulic loading resulting from excessive number of dwelling occupants or leaky plumbing fixtures,
- Loss of infiltrative capacity of the soil caused by physical, biological or chemical clogging of the soil by normal or unusual constituents in the wastewater, and
- Overloading of the system and loss of wastewater percolation capacity due to wet weather and storm conditions (inflow from surface runoff, direct infiltration into *the* system, elevated water table, saturated or near saturated soil conditions due to infiltration, storm induced tidal surge, leaky house sewer line, gutter or area drain connections to *the* sewer line).

Failing individual wastewater systems which are unable to percolate the applied flows may result in wastewater backing up in household plumbing fixtures and wastewater spills in the yard. The wastewater overflows may pond in low lying areas or run off into the street, drainage ways and neighboring property. Particularly during wet weather, the wastewater overflows may enter streams and eventually the ocean. Problem cesspool areas currently exist in the Flamingo St. area adjacent to Waimanalo Stream. Cesspools may be partially responsible for the elevated concentrations of enterococci and fecal coliform bacteria observed under storm conditions in shoreline monitoring at the mouth of Waimanalo Stream (see discussions in Chapter 3). In hilly areas, leachates may "daylight" at the foot of slopes and then run off into other areas.

Overflow conditions pose a significant public health risk from pathogenic organisms in the wastewater. Public health risks include a wide variety of diseases caused by pathogenic bacteria, viruses, protozoa, and helminths, including gastroenteritis, legionellosis, typhoid fever, cholera, infectious hepatitis, and cryptosporidiosis.

Failing individual wastewater systems in Waimanalo are typical of failing systems in other areas of Oahu. Cesspool failures in the inland areas can be attributed to location of the cesspools in low permeability soils, clogged infiltrative surfaces, perched groundwater conditions, adverse weather conditions, and overloading due to large household size. Cesspool failures in the coastal areas may be similarly attributed to undersized systems, clogged infiltrative surfaces, high water tables (in low elevation areas), and excessive household size. Although the sandy soil in the coastal areas offer high infiltrative capacity, the cesspools are generally constructed much shallower due to the expected high percolation rate and difficulties in shoring the excavation (particularly below the water table). Based on a review of soils data for Waimanalo, the sandy coastal area may have some isolated pockets of low permeability soils.

The primary remedial action for failing cesspool systems in areas with no sewers would be to increase the capacity of the individual wastewater system. Under current regulations, this would generally involve the construction of a new septic tank system and soil absorption system. Such systems would typically cost on the order of \$10,000 to \$15,000. The substantial number of existing failing systems may be due to the high cost of installing a new septic tank system. In the coastal areas of Waimanalo, homeowners may be reluctant to invest in a new system due to previous plans to service the area with municipal sewers. Enforcement action by DOH, and modifying the City's cesspool pumping policy (making frequent pumping more difficult or costly), would prompt more homeowners to upgrade their systems and thereby reduce the number of failing systems.

Other potential remedial actions for failing systems include use of water saving devices and practices, improvement of storm drainage within and around the property, installation of a septic tank upstream of the cesspool (to reduce the loading of clogging solids, organic material and grease), installation of supplemental soil absorption beds or trenches (subject to DOH approval), and use of chemical treatment. Chemical treatment using sulfuric acid or other acids is often effective in calcareous soils but may eventually result in structural problems due to dissolution of coral material by the acid. Enzymes and other additives have also been used with varying success.

d. Water Quality Impacts from Individual Wastewater Systems in Inland Areas

The hydrogeology of the Waimanalo study area was discussed in Chapter 3. There are distinct differences between the aquifers impacted by individual wastewater systems located in the inland and coastal areas (see Figure 3-7).

Inland individual wastewater systems are not expected to have significant impacts on coastal waters. The leachates would tend to flow slowly for a considerable distance through low permeability alluvial sediments and then through the brackish aquifer comprised of highly permeable calcareous sediments. Some individual wastewater systems may discharge directly into the permeable calcareous aquifer. Leachates, once in the calcareous aquifer, would have a fate similar to that previously discussed for the Waimanalo WWTP effluent. Based on the estimated population of 1,400 persons living in the inland agricultural lots and a per capita generation rate of 0.031 lb/day, the mass emission of nitrogen from individual wastewater systems from these parcels is 43 lb/day. Mitigation of impacts to coastal water, if any, would be of much lower priority than mitigating impacts of individual wastewater system located in the coastal areas.

Impacts to stream water quality due to leachates, spills and surface runoff from the inland individual wastewater systems, however, may be significant. Streams cutting through the inland areas intercept groundwater flows which are likely to contain leachates from nearby individual wastewater systems. As indicated in Chapter 3, nitrogen and microbiological contaminant levels in the Waimanalo streams are fairly high. Anecdotal information indicates that overflows from many individual wastewater systems may be intentionally or inadvertently being allowed to discharge directly to adjacent streams. Inspections and enforcement action by DOH would be a means to mitigate adverse impacts to public health and stream water quality.

e. Water Quality Impacts from Individual Wastewater Systems in Coastal Areas

In comparison to the inland areas, leachates from individual wastewater systems located in the sandy coastal areas would tend to have greater impact on nearshore coastal water quality. The individual wastewater systems are located near the shoreline and due to the low ground surface elevations in the area, some of the cesspools may be discharging directly into the groundwater or very near the water table. The low salinity leachates may have a tendency to "float" on the saline groundwater, flow through the sandy soil, and "daylight" at the shoreline.

The two primary areas of concern are:

- Pathogenic microbes (primarily bacteria and viruses) resulting in public health risks in recreation waters, and
- Nutrients (primarily nitrogen) resulting in algal blooms in coastal waters,

A literature review was conducted to provide background information on individual wastewater systems with respect to attenuating contaminants that may impact public health and water quality. The findings are presented in Appendix C. The review focused on the removal or inactivation of pathogenic microbes (primarily bacteria and viruses) and removal of nutrients, particularly nitrogen. The literature generally indicate that the effectiveness of individual wastewater systems varies and depends on many factors. Two major factors include the soil type and the distance to groundwater (depth of unsaturated soil). Fine soils and unsaturated soils are generally effective in removing microbiological contaminants. Although individual wastewater systems generally provides some nutrient removal, the discharge of nitrates is often a concern.

In addition to a literature review, field investigations by the University of Hawaii Water Resources Research Center (WRRC) were conducted as part of the Waimanalo Wastewater Facilities Plan. The study report (Hoover, et al., 1997) is included in Appendix D. The study involved the installation of four monitoring wells for sampling of groundwater. Two wells were located mauka of the beach lots area and the other two wells were on *the* makai side of the beach lots area.²

Potential public health impacts from contamination of recreational waters in Waimanalo by microbiological contaminants from subsurface leachates of individual wastewater systems appear to be relatively insignificant. Groundwater investigations and literature information indicate that pathogens in the leachates are likely to be effectively removed within the sandy soil in the coastal areas. Water quality data presented in Chapter 3 also support this conclusion. In general, the level of microbiological contaminants found in both the mauka and makai monitoring wells were very low. Exposure to

²Funding constraints limited the number of sampling points and the duration of the investigation. It was anticipated from the start of the study that the results would be preliminary in nature and that further studies would be required to achieve definitive conclusions.

saline water and *the* dilution effect at the shoreline would further reduce microbial contaminant concentrations.

A high removal efficiency for microbial contaminants in Waimanalo is plausible based on the excellent performance of slow sand filters in removal of microbiological contaminants in potable water. The Jaucas sand in which the coastal area cesspools are located appears to be functioning in a manner similar to a slow sand filter. Filtration efficiency is primarily attributed to the layer of bacterial slime and debris (called "Schmutzdecke") that accumulates on the surface of the sand media.

The WRRC researchers indicated that it is possible that the cesspool plume may have "missed" the monitoring wells. This would appear highly unlikely due to the high concentration of cesspools in the area, the broadening of the plume with downstream travel, the tidal pumping action near the shoreline, and the finding of high nitrogen levels in the wells. Cesspools systems upstream of the monitoring wells, however, may have been shallow and/or lightly loaded. The geology in the area could also potentially vary and water samples obtained from other locations could potentially yield different results and conclusions. The researchers have recommended that viruses be further investigated since the use of larger sample volumes than those used in the study may result in the recovery of viruses. Additional microbiological sampling and analyses would be warranted prior to formulation of final conclusions related to the microbiological contaminant removal effectiveness of individual wastewater systems in Waimanalo.

Based on the results of groundwater investigations, nitrogen, primarily in the form of soluble nitrates, would appear to be the primary contaminant of concern with respect to coastal water quality and individual wastewater system discharges. High levels of total nitrogen (equal or greater than 7 mg/L) were found in three of the four monitoring wells. A 42 mg/L concentration of total nitrogen was measured in a makai well sample. This high level of nitrates may potentially be due to substantial contribution of nitrogen from individual wastewater systems. A mauka well sample, however, had a total nitrogen concentration exceeding 14 mg/L. This well may be receiving a significant input of nitrogen from upgradient sources, such as from agricultural activities at higher elevations of the watershed. Cesspool leachate flow in the reverse (makai to mauka) direction due to "mounding" of the water table from cesspool leachates may also be a cause of the elevated nitrogen levels. The non-homogeneous nature of the area's geology and resulting unpredictable groundwater flow patterns are possible causes for the widely varying nitrogen concentrations among the wells.

The high nitrogen levels in the groundwater are a concern particularly due to the relatively high nitrogen levels and algal blooms occurring along the Waimanalo coastline. Based on approximately 2,700 persons served by individual systems in the coastal area, an estimated 84 pounds per day of nitrates could be generated.

Unfortunately, the results of the groundwater study do not provide sufficient information to assess the relative extent of the other upstream nitrogen sources. The extent of denitrification (conversion of nitrate to nitrogen gas) in the vicinity of the cesspools is also unknown. It is possible that a fair amount of denitrification is occurring in the immediate vicinity of the cesspool and the observed high level of nitrates is due to other upstream nitrogen sources. In the immediate vicinity of the cesspool, there may be sufficient denitrifier bacterial populations, organic carbon, and low dissolved oxygen conditions to support denitrification. The occurrence of significant denitrification in the sand stratum beyond the immediate vicinity of the cesspools, however, is highly unlikely based on the field investigation findings. Reasons include the lack of a carbon source,³ probable lack of denitrifying bacteria in the sandy soil (bacteria is filtered out), and the relatively high dissolved oxygen levels in the groundwater.

A photograph of an algal bloom in Waimanalo Bay was obtained and included in this document as recommended by comments from the University of Hawaii Environmental Center on the Draft Supplemental Environmental Impact Statement (see Chapter 10). The photograph, shown on Figure 5-1, is believed to have been taken within the past two years. The identity of the photographer is unknown. Although somewhat obscured by cloud shadows, the photograph clearly shows a portion of the nearshore waters having a greenish hue. The algal bloom is estimated to be located at least several hundred feet southeast of the mouth of the non-perennial Muliwaiolena Stream. It is uncertain whether the algal bloom is caused by nutrients in the groundwater discharged in the immediate area or by nutrients from other surface and subsurface sources transported to the area by ocean currents. Hoover, et al. (1997) indicated that man-made utility trenches and naturally occurring inhomogeneous geological conditions may significantly impact groundwater flow patterns in the region

The detailed assessment of algal problems in Waimanalo Bay is beyond the scope of the Waimanalo Wastewater Facilities Plan. Algal blooms appear to

³The field data indicated very low levels of total organic carbon (TOC).

DATE: 12/21/88
SCALE: 1" = 1'
FILE: 9524-53b

MS
PJ: OPER: FA
REVISED: -



HP Hawaii Pacific Engineers, Inc.
CONSULTING ENGINEERS

WAIMANALO WASTEWATER
FACILITIES PLAN

*PHOTOGRAPH OF ALGAL
BLOOM IN WAIMANALO BAY*

FIGURE 5-1

Notes:

- 1) *Identity of photographer unknown.*
- 2) *Photograph furnished by Waimanalo resident Nancy Glover.*

be prevalent following rain events based on input from residents participating in a mail-out survey (see Chapter 10). Streams and other runoff most likely contribute substantially to the nutrient loading of the coastal waters. Increased groundwater flux resulting from rainfall events also results in flushing of the nitrogen laden groundwater into coastal waters. This may have significant impacts during the critical post-storm periods. Since the sources of nitrogen are abundant in Waimanalo, it is also possible that phosphorous is the primary limiting nutrient and the key to controlling algal blooms. Runoff containing high levels of phosphorous may be the primary cause of post-storm algal blooms.

It is recommended that additional investigations be conducted to better identify the sources, quantities and fate of nutrients generated from various activities and land uses within the Waimanalo watershed. A more extensive water quality monitoring program and the use of more sophisticated analytical methods as previously discussed should be considered. These studies are recommended to determine whether there is a sound water quality basis that justifies the high cost of sewerage existing homes in the coastal area.

In conclusion, the proposed installation of sewers to eliminate the use of approximately 350 individual wastewater systems in the coastal beach lot area, if implemented, will reduce the contribution of nitrogen, an undesirable biostimulatory nutrient, into Waimanalo Bay. This would eliminate one of the suspected contributing causes of periodic algal blooms in the Waimanalo coastal waters. Spills and wastewater system backups caused by defective or overloaded individual wastewater systems, although not a major problem in the area, will be eliminated to provide some additional long-term benefits to public health and water quality.

The proposed wastewater system improvements, however, do not include the sewerage of all areas currently served by onsite individual wastewater systems due to economic constraints and limited anticipated cost-effectiveness. Public health concerns due to spills from existing overloaded systems in areas not proposed to be sewerage will need to be mitigated by expanding existing or constructing new individual wastewater disposal systems. If the discharge of nitrogen to nearshore waters is identified as a problem following the completion of additional recommended investigations, the use of individual wastewater systems with nitrogen removal capability should be investigated.

5. Nonpoint and Other Source of Pollution

The focus of the Waimanalo Wastewater Facilities Plan is on the management of domestic sewage. In assessing the water quality and wastewater facility needs of Waimanalo, it was considered appropriate to also briefly examine the potential impacts of other sources of pollution in Waimanalo.

Historically, pollution control regulations have concentrated on "point" sources of pollution, i.e. those that could be readily identified as a single, concentrated discharge. An example of a point source in the Waimanalo planning area would be the Waimanalo WWTP, which discharges disinfected secondary effluent into groundwater.

In recent years, as pollution from point sources have been increasingly controlled, the serious impacts stemming from polluted runoff or "nonpoint source pollution" has gained much attention. Nonpoint source pollution refers to pollutants that enter a body of water as a result of water flowing over the surface of the land, such as rainfall and irrigation water. The Waimanalo planning area is subject to considerable nonpoint source pollution due to considerable urban development and agricultural activities in the area.

A brief overview of other point and non-point pollution sources of concern in Waimanalo is presented below.

a. Storm Runoff Discharges

As indicated in Chapter 3, under wet weather conditions, the water quality of Waimanalo's nearshore waters appears to be degraded by the effects of nonpoint sources of pollution discharging to Waimanalo Stream and Inoaole Stream. This conclusion is supported by both the monitoring program results and anecdotal observations by residents. Elevated levels of bacteriological contaminants, and algal blooms caused by high nutrient levels, appear to occur after heavy rainfall events.

Under wet weather conditions, Waimanalo's storm drainage facilities and streams that discharge to coastal waters receive a significantly increased load of sediment, debris, bacteriological contaminants, and nutrients. Contaminants typically of concern include silt, fertilizers, livestock wastes, oil and other automotive products, litter and other trash, and overflows from individual wastewater systems. Natural contaminants such as soil from erosion, leaves and other dead vegetation, fecal wastes from feral animals and other wildlife, and dead animals may also add to the pollutant loads.

An assessment of the pollutant loads from nonpoint storm runoff is beyond the scope of *the* facilities plan project. A comprehensive watershed assessment appears to be justified for Waimanalo due to the existing water quality problems. Insufficient information is available based on the findings of this study to determine whether wastewater discharges, particularly from individual wastewater systems in the coastal areas, are a significant cause of the water quality problems.

b. Diversified Agricultural Activities

Two potentially significant sources of nonpoint pollution in Waimanalo are livestock wastes and crop farming activities.

(1) Livestock Wastes

Wastes from animal husbandry typically include fecal and urinary wastes of livestock and poultry, washdown water, feed, bedding litter, and the soil contaminated by the wastes. Pollutants include organic matter, nutrients and microbiological contaminants.

In the past, large quantities of animal waste were discharged to Inoaole Stream when waste lagoons from a cattle feedlot operation overflowed under wet weather conditions. The risk of pollution from this particular point source has been reduced with construction of waste holding lagoons designed to contain a 25-year recurrence interval storm. The feedlot operation currently has approximately 2,600 heads of cattle.

The many smaller livestock operations in Waimanalo may also be significant sources of pollution. Hawaii's Coastal Zone Pollution Control Program currently under development is focussing a considerable amount of its effort on the management of wastewater and runoff from livestock operations (Hawaii Coastal Zone Management Program, 1996). Requirements for containment of wastewater and runoff from a 25-year, 24-hour rainfall event has been proposed by the program.

(2) Crop Farming

Much of the land in Waimanalo is used for small scale agricultural crop production. Nonpoint source pollution problems associated with these operations tend to be inherent in its activities, which include disturbance of the land and use of fertilizers and pesticides. Hawaii's year-round sub-tropical climate leads to year round cultivation. A large amount of leased agricultural land is used for agricultural operations. Lessees have

less incentive to install permanent pollution control structures and fulfill other long-term stewardship responsibilities (Hawaii Coastal Zone Management Program, 1996).

c. Recreational Activities

Users of recreational waters themselves may be a source of contaminants that may degrade water quality. Hanauma Bay is one example where heavy bather loads may be significantly impacting water quality. Sources of contaminants include fecal material, urine, suntan lotion, body oils, animal droppings, and litter of various types. Wastewater discharges by boaters and larger ships in deeper waters may potentially have a noticeable impact on water quality and the cleanliness of the beaches. The extent of these impacts may be mitigated by instituting public education programs and through increased enforcement activities by appropriate government agencies.

d. Unisyn Biowaste Technology Waste Processing Facility.

The Unisyn Biowaste Technology operates an organic waste processing facility which is located approximately one-half mile inland of the Waimanalo WWTP. The facility uses a combination of anaerobic digestion, composting and other processes to process animal manure, green waste, grease trap pumping, food waste and other wet organic wastes. As byproducts of the waste processing, the facility produces compost, fertilizer and energy. The facility has been subject to scrutiny by the Waimanalo community due to odor complaints and environmental concerns, and is currently involved in litigation with a private party.

Based on a Draft Environmental Assessment (Unisyn, 1997) for the facility, the discharge of process effluent is expected to increase from 8,000 gallons per day (gpd) to 24,000 gpd in the future. The effluent is either reused in composting or other process operations or discharged to the Wing King Reservoir for irrigation use by others. The specific characteristics of the effluent were not indicated in the report.

Insufficient information and limited resources did not permit the detailed investigation of water quality impacts of the Unisyn facility effluent as part of the Waimanalo Wastewater Facilities Plan. The expenditure of public funds by *the* City to investigate and evaluate the impacts of a specific private entity was not justified. Unisyn will ultimately need to address its own specific wastewater treatment and disposal needs, and the associated

environmental impacts. The draft environmental assessment was withdrawn because the State Department of Land and Natural Resources (DLNR) determined that it was not required. A new environmental assessment, however, is currently under preparation as part of the Special Use Permit and Conditional Use Permit, Type 2 permitting process administered by the City and County of Honolulu.

Water quality problems in Waimanalo will need to be addressed on a long-term basis by other actions in addition to those proposed by Waimanalo Wastewater Facilities Plan. Best Management Plans (BMPs) will need to be instituted to control discharge of pollutants from a wide range of sources, particularly nonpoint sources. The report entitled, "Hawaii's Coastal Nonpoint Pollution Control Program, Management Plan, Volume 1," (1991) prepared by the Hawaii Coastal Zone Management Program, Office of State Planning, provides extensive recommendations for pollution management. Some recommendations that are applicable to Waimanalo include:

- Agriculture (erosion and sediment control; wastewater and runoff control from confined animal facilities; nutrient and pesticide management; grazing management; and irrigation water management)
- Urbanized areas (management of new developments and site development; watershed protection; construction site erosion, sediment and chemical control; onsite disposal systems management; household and commercial activity hazardous materials management; and management of road/highway pollutants)
- Wetland and riparian areas (restore wetlands or construct new wetlands and vegetated filter strips for nonpoint pollution abatement)

Land Use, Development and Social Impacts

The proposed improvements to the Waimanalo wastewater facilities will allow future planned development to occur. Conversely, failure to expand capacity will restrict future growth in Waimanalo. Increased development in Waimanalo may potentially have secondary long term impacts. Examples of potential secondary impacts include increased traffic congestion; added needs for schools, parks and other public facilities; additional demands on utility systems; and further loss of the rural agricultural nature of Waimanalo. *Some of the adverse impacts associated with the growth of Waimanalo's population can be mitigated by timely planning and implementation of other supporting infrastructure improvements. Appropriate planning and design of*

new developments to help maintain the rural agricultural characteristics of Waimanalo should be utilized to the extent possible.

Adverse impacts from increased development should be attributed to land use planning policies rather than the proposed action to provide adequate wastewater infrastructure. The Koolaupoko Development Plan is the City and County of Honolulu's primary means of regulating land use in Waimanalo. The current development plan classifies Waimanalo as a rural area, and limits the construction of new housing in the area. It should be noted that the projected developments planned by the DHHL, OHA and Bellows AFS (Hawaii Army National Guard) are not subject to the restrictions of the development plan. A concerted effort to be generally consistent with the area's planning objectives, however, is anticipated among the agencies responsible for these developments.

Much of the projected growth in Waimanalo is associated with DHHL and OHA projects that benefit persons of Hawaiian descent. These projects will benefit those who are economically disadvantaged, families currently housed in overcrowded dwellings, and elderly persons.

Residents to be serviced by sewers that currently rely on individual wastewater systems would have the long term benefit of not being burdened by existing or future problems of overloaded systems, and the need for pumping service.

Land Alteration, Aesthetics and Impacts to Surrounding Community

There are no significant adverse long term land alterations or aesthetic impacts associated with the proposed expansion of the wastewater collection system and Waimanalo WWTP.

The proposed sewer lines will be located below ground and within the public right-of-way. There will be no impacts on coastal scenic and open space resources. There will be little or no loss of prime agricultural land from the proposed action. The availability of reclaimed water may potentially encourage additional agricultural land to be cultivated.

The proposed improvements to the Waimanalo WWTP will be confined to the existing plant site and are not anticipated to have significant adverse long term impacts on the surrounding area. Although additional facilities will be constructed, the aesthetics of the plant site will not be significantly altered. Landscaping will be provided to improve the aesthetics of the plant facilities.

The use of ultraviolet effluent disinfection in lieu of chlorination will benefit the community and the plant personnel by eliminating safety hazards associated with the transportation and handling of chlorine gas.

Long-term noise and odors impacts, which have been significant concerns at other treatment facilities, are discussed separately below.

Noise Impacts

The generation of noise is not anticipated to be significantly increased as a result of the expanded Waimanalo WWTP facilities. New mechanical noise generating equipment will be provided with noise attenuation features and/or located in acoustically treated buildings. The facilities will be designed to comply with the Title 11, Administrative Rules, Chapter 43, "Community Noise Control for Oahu" noise standards established by the State Department of Health.

Air Quality Impacts

1. General

Air quality impacts are locally regulated under Title 11, Administrative Rules, Chapter 59, "Ambient Air Quality Standards," and Chapter 60.1, "Air Pollution Control," of the DOH.

Both Federal and State regulations specify air quality standards for major pollutants. Maximum allowable concentrations are specified for "criteria pollutants" such as suspended particulate matter, sulfur dioxide, carbon monoxide, hydrocarbons, photochemical oxidants, nitrogen dioxide and lead to protect public health and welfare. Since the Waimanalo WWTP does not employ sludge incineration or other processes which involve significant fossil fuel combustion, compliance with air quality standards is not anticipated to be an issue. The size of the proposed new standby emergency generation has not yet been determined. The standby emergency generation equipment, however, is expected to meet the air quality permit exemption requirements of Chapter 60.1 due to its use only during power outages and its classification as a "non-major" source of emissions.

Although regulated air pollutants are not anticipated to be an issue with the proposed wastewater facilities, odors and wastewater aerosols may be a potential concern.

The use of ultraviolet effluent disinfection in lieu of chlorination will benefit the community and the plant personnel by eliminating safety hazards associated with the transportation and handling of chlorine gas.

Long-term noise and odors impacts, which have been significant concerns at other treatment facilities, are discussed separately below.

Noise Impacts

The generation of noise is not anticipated to be significantly increased as a result of the expanded Waimanalo WWTP facilities. New mechanical noise generating equipment will be provided with noise attenuation features and/or located in acoustically treated buildings. The facilities will be designed to comply with the Title 11, Administrative Rules, Chapter 43, "Community Noise Control for Oahu" noise standards established by the State Department of Health.

Air Quality Impacts

1. General

Air quality impacts are locally regulated under Title 11, Administrative Rules, Chapter 59, "Ambient Air Quality Standards," and Chapter 60.1, "Air Pollution Control," of the DOH.

Both Federal and State regulations specify air quality standards for major pollutants. Maximum allowable concentrations are specified for "criteria pollutants" such as suspended particulate matter, sulfur dioxide, carbon monoxide, hydrocarbons, photochemical oxidants, nitrogen dioxide and lead to protect public health and welfare. Since the Waimanalo WWTP does not employ sludge incineration or other processes which involve significant fossil fuel combustion, compliance with air quality standards is not anticipated to be an issue. The size of the proposed new standby emergency generation has not yet been determined. The standby emergency generation equipment, however, is expected to meet the air quality permit exemption requirements of Chapter 60.1 due to its use only during power outages and its classification as a "non-major" source of emissions.

Although regulated air pollutants are not anticipated to be an issue with the proposed wastewater facilities, odors and wastewater aerosols may be a potential concern.

2. Odors

Odors are typically the most significant concern with wastewater treatment facilities. Hydrogen sulfide gas, product of septic wastewater conditions, is typically the most troublesome due to its detectability at low concentrations. Under Chapter 59, the ambient air quality standard for average hydrogen sulfide concentration is 25 parts per billion (ppb). Hydrogen sulfide is detectable at concentrations as low as 0.5 ppb.

The generation of odors is not anticipated to be noticeably increased as a result of the expanded Waimanalo WWTP facilities. The general lack of the characteristic "rotten egg" hydrogen sulfide odor at the existing plant indicates that hydrogen sulfide concentrations are far lower than that where it would constitute a public health concern. Plant operations personnel indicate that the Waimanalo WWTP has not received any complaints of odors originating at the plant in the past ten years. No changes to the land use or occupancy of the parcels in the immediate vicinity of the plant are foreseen that would increase the sensitivity to odors.

The Waimanalo WWTP has not had significant odor problems in the past and is not likely to have odor problems in the future largely due to the relatively small size of its sewage collection system. The detention time within the small system is relatively short and therefore wastewater does not exhibit a high degree of septicity. Wastewater septicity and the resulting generation of hydrogen sulfide gas is generally the primary cause of odors at treatment facilities. The influent wastewater also exhibits relatively low levels of septicity because the sewer system is comprised primarily of gravity sewers operating under an open channel flow regime. This permits some aeration of the wastewater and minimizes septicity as the flow is conveyed to the plant. In addition, relatively low levels of saline groundwater intrusion into the sewer system results in low levels of sulfate in the wastewater. This tends to further minimize the generation of odorous hydrogen sulfide gases. Lastly, the proposed upgrade of the plant will minimize the need for operations personnel to utilize the sewer lines for temporary storage of the wastewater on a daily basis during high flow periods. This current practice of storing wastewater in the sewer lines increases detention time and settling of solids within the collection system, which promotes septicity and generation of odors.

The new treatment process will utilize anoxic and aerobic processes which are effective in minimizing the generation of odorous gases. An activated sludge biological treatment process similar to that currently employed at the Waimanalo WWTP is proposed. This suspended growth process is substantially less prone

to odor problems than the fixed film biofilter process utilized at the City's other larger treatment facilities such as the Kailua Regional WWTP.

As in the past, odors generated by the use of the sludge beds for sludge dewatering should not be significant since the applied sludge will be first stabilized by the existing anaerobic digestion process. Methane gas generated by the anaerobic digesters will continue to be disposed of through the digester gas burner or possibly be reused as fuel in the future once a new digester sludge heater is installed. In general, the volume of sludge handled at the Waimanalo WWTP is relatively low compared to that of the City's other larger treatment facilities.

The Unisyn Biowaste Technology organic waste processing facility is located approximately one-half mile inland of the Waimanalo WWTP. Residents have complained about odors from the Unisyn facility as well as from a nearby dairy farm and pig farms. The odors from the Waimanalo WWTP is not anticipated to increase substantially in the future and it is unlikely that the proposed action at the plant would result in any measurable increases in cumulative odor impacts with the region. It would be difficult to substantiate this conclusion on a scientific quantitative basis, however, without significant expenditure of time, effort and funds. Based on the qualitative evaluation of odors, however, it would appear prudent to focus odor mitigation efforts on the other sources of odors.

If odors were found to be a problem at the Waimanalo WWTP in the future, odor control equipment could readily be installed to reduce odor emissions. The installation of odor control equipment is not recommended unless found to be necessary. In addition to their substantial cost and maintenance difficulties, odor control equipment indirectly contributes to air pollution due to energy consumed to operate the system and to manufacture and transport the odor control chemicals.

3. Microbial Emissions in Aerosols

Due to aeration of the wastewater, wastewater treatment facilities are a potential source of air borne aerosols containing bacteria, viruses and other microbial contaminants. The level of aerosol generation at the existing Waimanalo WWTP is not considered significant and is not projected to increase in the future. Fine and coarse bubble air diffusers and other types of aeration equipment used at the Waimanalo WWTP produces substantially less aerosols than mechanical type aerators used at other treatment facilities. Although the potential for infection or illness due to wastewater aerosols exists, there is currently no evidence among personnel at the Waimanalo WWTP or the surrounding neighborhood on adverse

health impacts. Studies by EPA (Pahren and Jakubowski, 1981) indicate that wastewater treatment plants do not appear to present a significant microbiological hazard to those working at or living near the facility. Some of the reasons cited included:

- Low density of pathogens in the aerosols which are reduced rapidly with time and distance from the source.
- Normal respiration would result in inhalation of relatively few organisms unless constantly exposed for many hours.
- Exposure levels below the minimum infective dose.
- Microorganisms in wastewater are primarily enteric organisms whereas the route of exposure is primarily respiratory.
- Nonspecific immunity, which responds quickly to foreign substances, is capable of handling the few microorganisms inhaled.

The DOH Chapter 62 "Wastewater Systems" regulations require a 25 foot setback between the property line and wastewater process tanks. Existing and proposed wastewater facilities at the Waimanalo WWTP substantially exceed the minimum setback distance.

Aerosols generated by spray irrigation of reclaimed water may potentially result in exposure of the aerosols to the general public, including persons with compromised immune systems. For this reason, the DOH has adopted highly stringent requirements for production and use of reclaimed water. As indicated in previous discussions, the "R-1" reclaimed water proposed to be produced by the upgraded Waimanalo WWTP will be generally comparable to potable water with respect to microbiological contaminants. Due to its high quality, there are no buffer zone requirements for spray irrigation application of "R-1" quality reclaimed water. In comparison, the lower quality "R-2" reclaimed water would require a 500 foot buffer zone for spray irrigation systems.

Solid Waste Disposal Impacts

As discussed in Chapter 1 and 2, beneficial reuse of the wastewater biosolids (sludge) from the Waimanalo WWTP and other City wastewater treatment facilities is envisioned in the future. Beneficial impacts will include reduction of waste input to landfills and beneficial recycling of nutrients. Composting and other additional special sludge treatment processes to enable production of a high quality biosolids product are not proposed at the Waimanalo WWTP site primarily due to odor and site flooding

concerns. Future offsite processing facilities, the location and nature of which have not yet been determined, will be subject to a separate environmental review process.

The use of UV disinfection technology will require proper disposal of used UV lamps to minimize adverse impacts to the environment. The UV lamps are similar to conventional fluorescent bulbs and are generally disposed of in the same manner. Used UV lamps resulting from major routine lamp change-out work are proposed to be shipped to a fluorescent bulb recycler. The nearest bulb recycler is located in California. Although small quantities of lamps (i.e., one to two lamps) could legally be disposed of as conventional trash, this would not be a practical nor environmentally sound means of routine lamp disposal.

Energy Consumption Impacts

The proposed expansion and upgrade of the Waimanalo WWTP will increase energy consumption due to the added unit treatment processes and increased capacity of the facilities. The monthly energy consumption is projected to increase from approximately 55,000 kwh at the present flow to approximately 150,000 kwh at the projected future 1.1 mgd flow. The proposed ultraviolet disinfection system will result in substantial usage of electricity for the disinfection process but will in turn eliminate energy associated with the manufacture and transportation of chlorine. *Energy consumption impacts will be mitigated by the use of energy efficient motors and process design.*

In Hawaii, air pollution and depletion of fossil fuels are indirect impacts of energy consumption due to dependence on oil and coal for energy production. There are also secondary indirect impact concerns regarding the escalation of global warming problems from the use of fossil fuels and production of carbon dioxide.

Economic Impacts

The long term economic impacts of the proposed actions are significant. The total capital cost of the project is estimated to be \$22.8 million (1998 dollars). The estimated annual operation and maintenance costs at the average design flow of 1.1 mgd is \$1.4 million (1998 dollars).

The City and County of Honolulu would be expected to fund the operating costs and potentially a portion of the capital costs. Based on current City policy, the financial impact of the City's portion of the cost would be *distributed* among the large number of wastewater system customers on Oahu. For determination of sewer rates, all the facilities operated by the City are considered to be a single system and the costs of the system are therefore distributed among all its customers.

The State of Hawaii government, which owns the majority of the facilities, may ultimately fund a substantial portion of the wastewater facility capital improvement costs. The financial impacts to *the* State are uncertain at this point in time because negotiations on financial arrangements for funding of the capital improvements between the DLNR and the City are ongoing and have not been completed. Low interest loans such as those from the State Revolving Fund (SRF) administered by the DOH may be pursued to help fund the improvements. It is anticipated that DHHL and other private and government agencies performing development work in Waimanalo will be required to fund a portion of the capital costs through payment of the standard facility charges to the City.

Costs associated with the facilities for production of reclaimed water are anticipated to be funded by the users of the water as well as various stakeholder government agencies. In addition to DLNR, contributing government agencies potentially include the State Department of Agriculture, National Resource Conservation Service, City Department of Environmental Services, and Honolulu Board of Water Supply. Costs should be allocated such that the reclaimed water costs from the users standpoint are competitive with that of alternative sources of water. Pricing of reclaimed water may need to be set lower than that of alternative water sources to compensate for administrative, monitoring and other costs and special requirements associated with reclaimed water use. The users, however, should not benefit excessively or unjustifiably from government subsidies supporting the production of reclaimed water. Government subsidies may be justified based on water quality benefits, and economic benefits of increased agricultural production. The State Department of Agriculture has indicated that there is a shortage of water during dry periods and that the availability of reclaimed water will likely increase agricultural production in Waimanalo. Subsidies for production of reclaimed water may also be justified by costs savings from eliminating the construction of other alternative water sources and additional effluent disposal facilities.

Residents served by individual wastewater systems that are proposed to be serviced by sewers under the proposed action would face the burden of paying for the construction of the house sewer lateral within their property and demolishing existing cesspools or septic tanks. The cost for this work is estimated to be on the order of \$4,000. The homeowners would also be responsible for paying for the City's one-time Sewer Improvement District assessment fee which is currently \$0.25 per square foot of lot area for residential areas.⁴ Residents would be required to pay the monthly sewer user service charge which covers operation and maintenance costs and a

⁴The improvement district assessment charge is based on the zoning lot size where the lot is larger than the zoning lot size. For example, in an area with R-10 zoning, the charge for a lot that is greater than 10,000 square feet would be calculated based on a 10,000 square feet lot size.

portion of the City's debt service. The sewer fee currently average approximately \$34 per month for a typical residential home. Economic benefits to residents requiring additional individual wastewater system capacity in the future would include not having to pay for upgrading their system and the recurring pumping costs. The cost of upgrading a cesspool to a new septic tank system is on the order of \$12,000.

Flooding Impacts

Due to the location of the Waimanalo WWTP in a flood hazard zone, a flood study specific to the treatment plant site will probably be required by the City Department of Planning and Permitting. The study would identify a certified flood elevation and evaluate flooding impacts, including the possible impact of proposed new structures on flood elevations.

The City Department of Planning and Permitting anticipates that the regulatory flood elevation for the Waimanalo WWTP site will be increased by several feet in the future. As indicated in Chapter 3, this is due to the results of a recent flood study for Inoaole Stream by the Corps of Engineers (R.M. Towill, 1997). The study projects a 100-year flood elevation of approximately 18 feet at the Waimanalo WWTP site. The study also indicates that the 100-year floodway boundary will encroach into the western portion of the treatment plant site.

New structures at the Waimanalo WWTP are proposed to be located outside the anticipated floodway boundary (see Figure 1-3). Existing buildings and plant equipment at the site are proposed to be flood proofed as required to minimize disruptions to the treatment process and damage to plant components during a major flood event. It is anticipated that full or at least partial treatment with disinfection will be capable of being maintained at the plant during a 100-year flood. Adequate disinfection of the wastewater would be the key goal during a catastrophic flood event. If necessary as an emergency measure, the manual addition of calcium hypochlorite may be performed to disinfect the wastewater.

The existing plant experienced minimal disruptions to operations and damage despite significant flooding which occurred in Waimanalo as a result of the January 1, 1988 storm. During this storm, the operations personnel indicated that the flood waters reached an elevation of slightly less than 14 feet above mean sea level at the plant site. There has been considerable debate, however, on the magnitude of the storm that caused the flooding. Depending on the methodology used and agency performing the determination, the storm has been designated anywhere from a 25 to 500 year storm.

portion of the City's debt service. The sewer fee currently average approximately \$34 per month for a typical residential home. Economic benefits to residents requiring additional individual wastewater system capacity in the future would include not having to pay for upgrading their system and the recurring pumping costs. The cost of upgrading a cesspool to a new septic tank system is on the order of \$12,000.

Flooding Impacts

Due to the location of the Waimanalo WWTP in a flood hazard zone, a flood study specific to the treatment plant site will probably be required by the City Department of Planning and Permitting. The study would identify a certified flood elevation and evaluate flooding impacts, including the possible impact of proposed new structures on flood elevations.

The City Department of Planning and Permitting anticipates that the regulatory flood elevation for the Waimanalo WWTP site will be increased by several feet in the future. As indicated in Chapter 3, this is due to the results of a recent flood study for Inoaole Stream by the Corps of Engineers (R.M. Towill, 1997). The study projects a 100-year flood elevation of approximately 18 feet at the Waimanalo WWTP site. The study also indicates that the 100-year floodway boundary will encroach into the western portion of the treatment plant site.

New structures at the Waimanalo WWTP are proposed to be located outside the anticipated floodway boundary (see Figure 1-3). Existing buildings and plant equipment at the site are proposed to be flood proofed as required to minimize disruptions to the treatment process and damage to plant components during a major flood event. It is anticipated that full or at least partial treatment with disinfection will be capable of being maintained at the plant during a 100-year flood. Adequate disinfection of the wastewater would be the key goal during a catastrophic flood event. If necessary as an emergency measure, the manual addition of calcium hypochlorite may be performed to disinfect the wastewater.

The existing plant experienced minimal disruptions to operations and damage despite significant flooding which occurred in Waimanalo as a result of the January 1, 1988 storm. During this storm, the operations personnel indicated that the flood waters reached an elevation of slightly less than 14 feet above mean sea level at the plant site. There has been considerable debate, however, on the magnitude of the storm that caused the flooding. Depending on the methodology used and agency performing the determination, the storm has been designated anywhere from a 25 to 500 year storm.

The mitigative flood proofing measures required at the Waimanalo WWTP is considered an unresolved issue since the extent and timeframe of the flood elevation revisions are uncertain. A budget of \$200,000 has been included in the proposed construction cost estimate for flood proofing improvements for buildings with key equipment, particularly motor controls and electrical equipment. Since flooding has wide-ranging impacts on Waimanalo, it is possible that some regional flood control improvements may be implemented in the future that may decrease the design flood elevation. During the preliminary engineering and design phases for future Waimanalo WWTP upgrades, the designers will need to carefully assess the cost-effectiveness of handling flood waters that may be substantially higher in elevation than those experienced during the 1988 flood. Certain flood control features such as higher tank walls and raised equipment operating platforms would be costly and have significant adverse impacts on ease of maintenance and personnel safety. The use of funds for downstream flood control improvements that would benefit the entire region would appear to be a more sensible approach to the flooding concerns.

During a major flood event, cesspools and septic tank systems may become inundated or adversely affected by the resulting high water table conditions. This may cause the contents of the individual wastewater systems to back up into homes or into the yard and/or surface drainage systems. Mitigation measures include requiring the use of conservative design criteria; providing adequate onsite and offsite lot drainage; and providing proper maintenance (periodic pumping of accumulated grease and sludge). During severe flooding conditions, wastewater spills may also occur from the sewer lines due to excessive rain-induced infiltration and inflow. Mitigation measures for the sewer system spills include regular cleaning of sewer lines (grease, sediment and tree root removal); repair of cracks and separated pipe joints; and removal of roof gutter, outdoor area drains, and other illicit connections.

The Waimanalo WWTP and Kahawai WWPS are located outside the tsunami evacuation zone (GTE Hawaiian Tel, 1998) and is not expected to be impacted directly by tsunamis. Sewers located in the Beach Lot area seaward of Kalaniana'ole Highway that are in the tsunami evacuation zone are not likely to be damaged since they are located below ground. Minor temporary increases in infiltration and inflow of salt water into the sewer system may result from flooding by the tsunami waves. As noted in Chapter 3, inundation along the Waimanalo coastline during major tsunamis in 1946, 1952 and 1960 only ranged between six and nine feet above the mean lower-low water (MLLW) level due to protection offered by the wide, shallow reefs. Major inundation of the Beach Lot area is unlikely since the sewers would be located in areas where the ground is higher than ten feet above MLLW.

Natural and Human Environmental Impacts on the Project

The project is not expected to be significantly impacted by various natural environmental hazards. Flooding impacts generated as a result of hurricanes, tsunamis and extreme storm conditions would be of greatest concern. Impacts associated with flooding were addressed in the discussions above. Impacts from other natural hazards such as high hurricane winds and earthquakes would be mitigated by designing the structures to meet all applicable building codes. Geotechnical investigation of subsurface conditions will allow proper design of foundations to minimize potential adverse impacts stemming from seismic hazards and other causes of unstable soils. The project is not located in an area where volcanic action and landslides are a significant concern.

The project may also be potentially affected by human environmental factors such as changes in population and the degree of urbanization. Significant adverse impacts are not expected if the rate of population growth or extent of urbanization is higher or lower than that originally projected for this project. If population growth and urbanization occurs at a higher rate than projected, the wastewater facilities would simply be required to be expanded at an earlier date in the future. Moratoriums on new projects and sewer connections can be avoided by proper planning and monitoring of the area's growth. This will provide sufficient lead time to secure funding and implement the necessary design and construction activities. Conversely, a lag in population growth and urbanization will allow future expansion of the wastewater facilities to be delayed. Increases in the level of urbanization of Waimanalo would not be expected to have major impacts on the project provided that the land uses in the immediate vicinity of the Waimanalo WWTP remain compatible with the plant operations. The installation of odor control facilities, as discussed earlier in the chapter, may be implemented if odors became an issue due to changes in the surrounding land use.

SHORT TERM IMPACTS

Short-term impacts are limited primarily to temporary disruptions associated with construction activities.

Land Alteration and Aesthetic Impacts

Short-term impacts associated with land alteration and aesthetics will result from the construction activities. The work will include trenching in paved and non-paved areas, stockpiling of materials, and general visual/aesthetic deterioration. The use of standard erosion control measures during grading, grubbing, trenching and other construction activities will minimize adverse erosion impacts. The construction

Natural and Human Environmental Impacts on the Project

The project is not expected to be significantly impacted by various natural environmental hazards. Flooding impacts generated as a result of hurricanes, tsunamis and extreme storm conditions would be of greatest concern. Impacts associated with flooding were addressed in the discussions above. Impacts from other natural hazards such as high hurricane winds and earthquakes would be mitigated by designing the structures to meet all applicable building codes. Geotechnical investigation of subsurface conditions will allow proper design of foundations to minimize potential adverse impacts stemming from seismic hazards and other causes of unstable soils. The project is not located in an area where volcanic action and landslides are a significant concern.

The project may also be potentially affected by human environmental factors such as changes in population and the degree of urbanization. Significant adverse impacts are not expected if the rate of population growth or extent of urbanization is higher or lower than that originally projected for this project. If population growth and urbanization occurs at a higher rate than projected, the wastewater facilities would simply be required to be expanded at an earlier date in the future. Moratoriums on new projects and sewer connections can be avoided by proper planning and monitoring of the area's growth. This will provide sufficient lead time to secure funding and implement the necessary design and construction activities. Conversely, a lag in population growth and urbanization will allow future expansion of the wastewater facilities to be delayed. Increases in the level of urbanization of Waimanalo would not be expected to have major impacts on the project provided that the land uses in the immediate vicinity of the Waimanalo WWTP remain compatible with the plant operations. The installation of odor control facilities, as discussed earlier in the chapter, may be implemented if odors became an issue due to changes in the surrounding land use.

SHORT TERM IMPACTS

Short-term impacts are limited primarily to temporary disruptions associated with construction activities.

Land Alteration and Aesthetic Impacts

Short-term impacts associated with land alteration and aesthetics will result from the construction activities. The work will include trenching in paved and non-paved areas, stockpiling of materials, and general visual/aesthetic deterioration. The use of standard erosion control measures during grading, grubbing, trenching and other construction activities will minimize adverse erosion impacts. The construction

impacts will cease upon completion of construction and the affected areas will be restored to their original condition to the extent possible. Construction inspection and monitoring services will be provided to ensure that the contractor performing the work adheres to all environmental regulations applicable to construction activities.

Flora and Fauna Impacts

Based on review of available information, no endangered flora or fauna are anticipated to be found at the anticipated project sites. These project sites include *the* site of the Waimanalo WWTP, Kahawai Stream Wastewater Pump Station, State and City road rights-of-way, and easements on previously developed parcels. Waimanalo flora and fauna previously described and their habitats, particularly those of endangered species, are not anticipated to be encountered at sites impacted by the construction.

Archeological and Historical Sites Impacts

No significant archeological or historical sites are known to exist at the anticipated project sites. The proposed construction will essentially alter landscape already modified by the construction of existing homes, roadways and utility infrastructure. Should any unanticipated sites, artifacts or remains such as shells, bones or charcoal deposits be encountered, the work will be halted. Mitigating measures will be discussed with the State Historic Preservation Office and implemented as required prior to commencing work.

Comments on the Draft Supplemental Environmental Impact Statement (DSEIS) were submitted by the State Historic Preservation Division (SHPD) (see correspondence in Chapter 10). The SHPD indicated that the proposed rehabilitation of existing sewer lines and proposed upgrades to the Kahawai Stream Wastewater Pump Station and Waimanalo Wastewater Treatment Plant will have "no effect" on historic sites. It was indicated that these are existing facilities where historic sites are not known to exist and where historic sites were not recorded during development activities related to the installation of these facilities.

The SHPD indicated a concern regarding the potential for unknown human burials and other cultural deposits being disturbed during collection system improvements in the proposed future areas to be sewerred, especially along Bellows Air Force Station and the Waimanalo beach lot area (Waimanalo Sewers, Section 2 Improvement District). It was noted that the underlying sediments of Jaucas beach sand in these areas are known to contain human burials and other cultural deposits associated with traditional Hawaiian use of the area. Such disturbance would constitute an "adverse effect" on significant historic sites.

To counter any inadvertent adverse effect on significant historic sites, SHPD has requested that a written archeological monitoring plan be submitted for review and acceptance prior to the monitoring project. The SHPD indicated that the archeological monitoring plan would be required to contain the following specifications:

- *The kinds of remains that are anticipated;*
- *Where in the construction area the remains are likely to be found;*
- *How the expected types of remains will be treated, if found;*
- *The archaeologist conducting the monitoring has the authority to halt construction in the immediate area of a find in order to carry out the plan;*
- *A coordination meeting between the archaeologist and construction crew is scheduled, so that the construction team is aware of the plan;*
- *What laboratory work will be done on remains that are collected;*
- *A schedule for report preparation; and*
- *Details concerning the archiving of any collection that are made.*

If an acceptable monitoring plan is implemented, SHPD indicated that they believe that the proposed upgrade and expansion of the Waimanalo wastewater facilities will have "no adverse effect" on significant historic sites which may be in the project areas.

Water Quality Impacts

Dewatering of sewer line trenches and treatment unit foundation excavations is anticipated to be required. Temporary discharge of dewatering effluent to drainage facilities and streams may be required for the construction dewatering activities. The contractor will be required to obtain an NPDES construction permit for discharge of dewatering effluent which will impose mitigation requirements to ensure the discharge complies with regulatory requirements and best management practices.

Comments on the DSEIS were submitted by the Fish and Wildlife Service (FWS) of the United States Department of Interior (see correspondence in Chapter 10). The FWS expressed concern on the possible adverse water quality impacts of the dewatering effluent on the groundwater and streams. The discharge volume and quality of the dewatering effluent, however, is presently uncertain as they may vary substantially depending on the site specific soil/groundwater conditions and dewatering practices employed by the contractor.

Due to the lack of drainage facilities and nearby streams, dewatering effluent generated during the construction of sewers in the Section 2 Sewer Improvement District (see Figure 1-2b and Figure 3-16) is anticipated to be discharged into unbackfilled trenches or recharge pits. Dewatering is expected to be required for only for the construction of approximately 1,200 feet of sewer line along Hinalea and Hilu streets as the remaining sewers are likely to be located above the water table. Sheet piling is anticipated to be used to minimize the volume of dewatering effluent and to prevent caving of the sandy subsoil. No adverse impacts to stream water quality are anticipated. Groundwater pumped from the sewerline trenches will essentially be discharged back into the coastal basal aquifer without addition of any significant contaminants.

Dewatering effluent generated during construction of new treatment process tanks at the Waimanalo WWTP is anticipated to be disposed of in a nearby grass-lined drainage ditch, recharge pits, or the existing effluent disposal wells. The drainage ditch, which is located along the northern boundary of the adjacent polo field, handles runoff from the plant site and discharges to Inoaole Stream. Inoaole Stream is classified as a non-perennial stream by the Hawaii Stream Assessment study (State of Hawaii Commission on Water Resources Management, 1990).

Water quality data for a groundwater sample obtained for an NPDES permit currently pending approval for the construction of effluent filters at the Waimanalo WWTP (R.M. Towill, 1998) are as follows:

Total Nitrogen	22,000	µg/l
Ammonia Nitrogen	230	µg/l
Nitrate + Nitrite	21,000	µg/l
Total Kjeldahl Nitrogen	< 750	µg/l
Total Phosphorous	730	µg/l
Turbidity	17	NTU
Total Suspended Solids	670	mg/l
pH	7.1	
Dissolved Oxygen	4	mg/l
Temperature	28	°C
Salinity	< 1.0	ppt
Oil and Grease	1.2	mg/l
Benzene	< 1	µg/l
Cadmium	< 5	µg/l
Ethylbenzene	< 1	µg/l
Lead	< 100	µg/l
Purgeable Hydrocarbons	< 50	µg/l
Toulene	< 1	µg/l
Total Xylenes	< 2	µg/l

The salinity of the groundwater sample, which was less than 1 part per thousand (ppt), is relatively low. The nutrient levels of the groundwater, however, are relatively high and may potentially result in algal blooms in the stream and nearshore coastal waters if dewatering effluent is discharged in significant quantities to the drainage ditch. It should be noted that the groundwater data is based on only one sample obtained from a single test boring hole. The water quality of the groundwater with respect to salinity, nutrient concentration, and other parameters could potentially differ under continuous pumping during actual dewatering operations.

Sheet piling is anticipated to be used to minimize the volume of dewatering effluent required to be pumped and to prevent caving of the sandy subsoil. The anticipated dewatering discharge for the effluent filter project is 200 to 300 gallons per minute (gpm) for 24 hours per day for a duration of up to three months (R.M. Towill, November 1998). Other treatment units to be constructed in the future will likely have similar or possibly slightly higher and/or more prolonged dewatering discharges.

The volume and quality of dewatering effluent that would actually enter Inoaole Stream is uncertain. Inoaole Stream is not perennial and visual observations indicate that there is generally no flow in the stream branch that receives flow from the Waimanalo WWTP site (see Figure 3-16). Percolation of the dewatering discharge into the ground as it flows along the approximately 2,000 foot long grass-lined ditch should substantially reduce or even eliminate flow to Inoaole Stream. Uptake of nutrients and removal of suspended solids by grass and other vegetation growing in the ditch will minimize potential water quality impacts on Inoaole Stream in the event that the flow reaches the stream. If necessary due to water quality impacts on Inoaole Stream, some or all of the dewatering effluent at the treatment plant site may be disposed of in recharge pits or the existing effluent disposal wells. Groundwater pumped from the excavations will essentially be discharged back into the coastal aquifer without addition of any significant contaminants. The effluent disposal wells should have sufficient capacity to accept the dewatering effluent except during peak wastewater flows that occur during storm conditions. Discharge of the relatively small volume of dewatering effluent to the drainage ditch and Inoaole Stream during storm conditions should have a negligible impact on water quality relative to the stormwater runoff.

The contractor will be required to minimize generation of silt-laden runoff from active work areas, construction access roads, and material stockpiles.

Noise and Air Quality Impacts

The use of construction equipment such as backhoes, trucks, hand compactors, and pavers will create noise, dust and exhaust emissions.

The noise level will increase during the construction period. The noise of construction equipment will be minimized by ensuring properly functioning mufflers on machinery, avoiding unnecessary "gunning" of equipment, and restricting construction activity during normal working hours. The contractor will be required to meet applicable vehicular and community noise standards established by the Department of Health.

Adverse air quality impacts of the proposed construction will include fugitive dust from excavation, grading and other construction activities. Adequate fugitive dust control of active construction sites will be facilitated by the use of frequent dust control watering. Wind erosion of inactive areas will be stabilized as required by the use of tarps, mulch, or chemical stabilizers. Haul trucks frequently track dirt onto paved streets adjacent to the construction site, often creating a significant source of dust. Measures such as tire cleaning and street sweeping will be used as necessary. In accordance with applicable regulations, open bed trucks will be required to be covered when loaded with materials likely to create a source of fugitive dust. Contract specifications will require the contractor to repave or complete landscaping of completed construction sites at the earliest possible date to minimize the potential for fugitive dust emissions.

On-site mobile and stationary construction equipment will also emit air pollutants from engine exhausts. Nitrogen oxides (NO_x) emissions from diesel engines typically used on construction equipment can be relatively high compared to gasoline-powered equipment. However, air quality standards for nitrogen dioxide are not likely to be violated by short-term construction equipment emissions. Carbon monoxide emissions from diesel engines are relatively low and are anticipated to be insignificant.

Traffic and Public Safety Impacts

Traffic along the proposed alignment for new pipeline construction or sewer rehabilitation work will be disrupted for short periods during construction. Residents in the immediate work area may be inconvenienced by restrictions to driveway access and roadway frontage usage. The contractor will be required to make provisions for emergency access and will be required to provide full access during non-working hours. Where applicable and necessary, parking may be temporarily restricted on both sides of the streets. It may be necessary for the contractor to use the public right-of-way for parking and temporary storage of vehicles and construction equipment.

As appropriate, construction contractors will be required to mitigate vehicular and pedestrian traffic problems and hazards through the use of appropriate traffic controls and safety devices. Examples of measures that may be employed include:

- Publication of newspaper notices to alert the public of construction projects.

- *Appraisal of the affected residents and neighborhood board of the project and its traffic impacts prior to the commencement of construction. Coordination by the contractor and the City on closure of private driveways with the affected property owners prior to the closure.*
- Advance signage and other warnings to alert approaching motorists and pedestrians.
- Barriers, cones, signage, lighting, non-skid covering over trenches, *adequate and safe sidewalk widths, adequate intersection visibility, and other provisions* to promote safe passage of vehicles and pedestrians through the construction zone.
- Flaggers and/or police officers, when necessary, to control the traffic and pedestrian flow.
- *Notification of emergency services (fire, ambulance and police) prior to implementation of any required detours or street closures. Notification of the City Department of Transportation Services to allow the City to alert Oahu Transit Services of the construction activity.*

The contractors will be also required to provide fencing or other appropriate barriers as necessary to deter the public from unauthorized entry into restricted or hazardous construction zones during working and non-working hours. The contractors shall be required to adequately secure equipment and supplies to discourage and deter theft and vandalism, and unauthorized entry into the construction and staging areas.

At the Waimanalo WWTP site, the contractors will need to take necessary safety precautions to protect the plant operations personnel from construction site hazards. Safety hazards and unauthorized entry with respect to the general public are less of a concern at the plant site due to an existing perimeter fence and 24-hour personnel staffing at the site.

Impacts to Utilities

Utility service (water, electric, gas, telephone, and cable TV) may be temporarily disrupted by the construction activities. The utility companies will be requested to review the construction plans and locate existing utilities in the field to minimize potential damage to the utilities by the contractor.

- *Appraisal of the affected residents and neighborhood board of the project and its traffic impacts prior to the commencement of construction. Coordination by the contractor and the City on closure of private driveways with the affected property owners prior to the closure.*
- Advance signage and other warnings to alert approaching motorists and pedestrians.
- Barriers, cones, signage, lighting, non-skid covering over trenches, *adequate and safe sidewalk widths, adequate intersection visibility, and other provisions* to promote safe passage of vehicles and pedestrians through the construction zone.
- Flaggers and/or police officers, when necessary, to control the traffic and pedestrian flow.
- *Notification of emergency services (fire, ambulance and police) prior to implementation of any required detours or street closures. Notification of the City Department of Transportation Services to allow the City to alert Oahu Transit Services of the construction activity.*

The contractors will be also required to provide fencing or other appropriate barriers as necessary to deter the public from unauthorized entry into restricted or hazardous construction zones during working and non-working hours. The contractors shall be required to adequately secure equipment and supplies to discourage and deter theft and vandalism, and unauthorized entry into the construction and staging areas.

At the Waimanalo WWTP site, the contractors will need to take necessary safety precautions to protect the plant operations personnel from construction site hazards. Safety hazards and unauthorized entry with respect to the general public are less of a concern at the plant site due to an existing perimeter fence and 24-hour personnel staffing at the site.

Impacts to Utilities

Utility service (water, electric, gas, telephone, and cable TV) may be temporarily disrupted by the construction activities. The utility companies will be requested to review the construction plans and locate existing utilities in the field to minimize potential damage to the utilities by the contractor.

Economic Impacts

The project will provide employment for contractors and their employees, material suppliers, and others associated with the construction industry.

There may be some short term economic impacts to commercial establishments due to construction of a force main along Kalaniana'ole Highway between the Waimanalo WWTP and the Olomana Golf Links effluent reuse site. Impacts may be minimized by maintaining access during normal business hours, providing adequate traffic controls, and maintaining effective noise and dust control. These impacts would not be expected to directly affect any one commercial establishment longer than one to two weeks.

STATE REVOLVING FUND (SRF) FEDERAL "CROSS-CUTTING" AUTHORITIES

A portion of the funds for the proposed action may potentially be obtained from the DOH State Revolving Fund (SRF) loan program. The SRF program requires that impacts relative to the following Federal "cross-cutting" authorities be addressed:

- Archeological and Historic Preservation Act (16 U.S.C. § 469a-1)
- Clean Air Act (42 U.S.C. § 7506 (c))
- Coastal Zone Management Act (16 U.S.C. § 1456 (c) (1))
- Endangered Species Act (U.S.C. § 1536 (a) (2) and (4))
- Farmland Protection Act (7 U.S.C. § 4202 (B))
- Fish and Wildlife Coordination Act (16 U.S.C. § 662 (a))
- Floodplain Management Act (42 U.S.C. § 4321)
- National Historic Preservation Act (16 U.S.C. § 470 (f))
- Safe Drinking Water Act (42 U.S.C. § 300h-3 (e))
- Protection of Wetlands (42 U.S.C. § 4321)

The proposed action is not anticipated to *have* any significant impacts associated with the above Federal cross-cutting authorities. The Federal requirements are generally administered locally through various government agencies. The evaluation of potential impacts of the proposed action with respect to applicable regulations and policies were addressed in the discussions presented in this chapter and other chapters of this document. Comments on the proposed action are solicited from the various agencies administering the regulations during the course of the Chapter, 343 Hawaii Revised Statutes and Title 11, Chapter 200 Hawaii Administrative Rules environmental review process.

Chapter 6

**Relationship Between Local Short-Term
Uses of the Environment and the Maintenance
and Enhancement of Long-Term Productivity**

CHAPTER 6

RELATIONSHIP BETWEEN LOCAL SHORT-TERM USES OF THE ENVIRONMENT AND THE MAINTENANCE AND ENHANCEMENT OF LONG-TERM PRODUCTIVITY

Proposed improvements to the Waimanalo Wastewater Treatment Plant (WWTP) and the wastewater collection system will have long term benefits that will offset short term uses or "costs" to the environment. The specific beneficial and adverse impacts associated with the proposed action were previously discussed in Chapter 5. The following discussions provide a brief assessment of the relationship and tradeoffs between the benefits and limitations of the proposed action with respect to the environment.

Benefits of the proposed action in terms of long term maintenance and enhancement of the environment include improvement of coastal water quality and ecosystems, and preservation of water resources. Potential water quality and marine ecosystem benefits would result primarily from reducing a discharge of biostimulatory nutrients into coastal waters from individual wastewater systems and the Waimanalo WWTP injection wells. Reducing the discharge of nitrogen may potentially reduce the probability of algal bloom occurrences in Waimanalo Bay. This would benefit the aesthetics of the recreational waters and may potentially have beneficial impacts on coral growth and other sensitive benthic marine life. Utilizing reclaimed water for irrigation would reduce the demand for potable and irrigation water in Waimanalo. It would also allow increased agricultural production on currently unused agricultural land.

The major impact from both a short term and long term viewpoint would be the substantial amount of financial resources that would be required to construct the proposed facilities and to operate and maintain the facilities. The funds would be drawn from a generally limited pool of tax dollars, assessment fees and operating fees. Funds expended for the proposed action would potentially reduce funds available for other environmental protection or enhancement projects.

The proposed action would involve consumption of energy for both construction and the operation and maintenance of the facilities. In many cases, particularly in Hawaii, the use of energy results in the depletion of non-renewable fossil fuels. The use of fossil fuel also results in air pollution and contributes to other potential adverse impacts such as global warming. These impacts in turn may have adverse impacts on the long-term productivity of our environment.

The proposed action does not narrow the range of beneficial uses of the environment or pose significant long-term risks to health and safety. The proposed action, in fact, should have net beneficial impacts to the environment and promote improved public health and safety. The proposed action will not result in irreparable harm to the land nor foreclose future options for use of the land.

Chapter 7

Irreversible and Irretrievable Commitments of Resources

CHAPTER 7

IRREVERSIBLE AND IRRETRIEVABLE COMMITMENTS OF RESOURCES

The proposed improvements to the Waimanalo Wastewater Treatment Plant (WWTP) and the wastewater collection system will involve the irreversible and irretrievable commitment of certain human and natural resources. These resources include financial capital, manpower, energy, and construction/operation materials and supplies. In addition, there will be a long-term commitment to the use of land.

Financial resources used for construction and operation of the proposed wastewater facility improvements, once committed and used for the project, will not be available for other uses. The use of reclaimed effluent is expected to produce environmental benefits but is not expected to result in lower cost irrigation water. The extent of irreversible and irretrievable financial commitment *towards* capital expenses will increase steadily with time as the value of the facilities decline due to the effects of age and depreciation. The funds used for operation and maintenance of the facilities are largely irreversible and irretrievable upon expenditure.

Manpower, energy, and construction/operation materials and supplies expended on construction and operation of the proposed facilities are largely irreversible and irretrievable. Certain materials, however, may be derived from renewable sources. Also, substitution of renewable non-fossil derived fuel to power the facilities may be realized in the future. Certain actions to reduce power consumption, such as using digester gas to heat the anaerobic digester, is proposed where such actions are technically feasible and cost-effective. The expenditure of resources for other materials and supplies for facility operations, such as lubricants, chemicals, ultraviolet disinfection light bulbs, potable water, and other consumed items are also irreversible and irretrievable. The consumption of potable water can be reduced by the use of reclaimed water for facility washdowns and watering of plant grounds.

The land committed to the proposed action could theoretically be reclaimed for other uses or returned to its natural state. This, however, is unlikely as long as the facilities are functional and required. The commitment of land area is relatively small.

Environmental and public health regulations, and the public's general support to comply with them, indicates a willingness to make irreversible and irretrievable commitments of resources to achieve the resulting benefits.

Chapter 8

Unavoidable Adverse Environmental Impacts

CHAPTER 8

UNAVOIDABLE ADVERSE ENVIRONMENTAL IMPACTS

The specific adverse impacts associated with the proposed action were previously discussed in Chapter 5 along with proposed mitigation measures. The following discussion provides a brief summary of the probable adverse environmental impacts which cannot be avoided. These adverse impacts are largely offset by the benefits of the project. These benefits include improved water quality and public health protection and production of reclaimed water.

WATER QUALITY AND PUBLIC HEALTH PROTECTION IMPACTS

The proposed action proposes to implement cost-effective improvements to Waimanalo's wastewater infrastructure that will improve water quality and public health protection. Despite the improvements, there may still be some adverse impacts from the disposal of wastewater in the region.

There will still be some contribution of nitrogen from individual wastewater systems and the Waimanalo Wastewater Treatment Plant (WWTP) to coastal waters which may promote undesirable algal blooms. Additional investigations are proposed to determine whether this contribution of nitrogen is a significant concern.

Failure of undersized or poorly designed individual wastewater systems may still occur in unsewered areas due to lack of funds for upgrade of the systems by the homeowners and for comprehensive inspection and enforcement by regulatory agencies. System failures may result in sewage spills and backups which result in odor problems and water quality and public health concerns. Problems may be particularly pronounced during major storm events and in areas subject to flooding.

The decision to not eliminate all adverse water quality and public health impacts is based on financial constraints and the concern for "cross-media" pollution impacts. There is increasing realization in the environmental field that solving the problem in one area (such as water pollution) may result in adverse impacts in other areas (such as air pollution due to energy consumption). The proposed action is based on a reasonable compromise to maximize benefits and minimize adverse impacts.

ENERGY CONSUMPTION IMPACTS

The proposed facilities *are* anticipated to utilize on the order of 150,000 kwh of electrical power per year. The use of electrical power on Oahu results in the use of fossil fuel resources and production of air pollution.

FINANCIAL IMPACTS

The proposed action will require the use of limited public funds. Homeowners that will have their individual wastewater systems replaced by sewers will be required to pay for connection costs, assessment fees and monthly sewer fees.

GROWTH IMPACTS

Although the proposed action is not intended to stimulate or stipulate growth, it will allow additional growth to occur in Waimanalo. This may be considered an adverse impact by some community members.

LAND USE IMPACTS

The proposed action will preempt the use of a relatively small amount of land from being used for agriculture, residential development, or other uses. The proposed reclaimed water reservoir is anticipated to only occupy approximately three acres of land which is currently not used for agriculture.

CONSTRUCTION IMPACTS

There will be some unavoidable adverse short-term impact related to the construction of the proposed improvements. Some of the probable adverse impacts despite mitigation efforts include visual/aesthetic deterioration, noise, fugitive dust, erosion, construction equipment exhaust, construction dewatering/runoff discharges, and traffic congestion. These impacts will be greatest during the installation of pipelines in residential areas and along the Kalaniana'ole corridor.

Chapter 9

Summary of Unresolved Issues

CHAPTER 9

SUMMARY OF UNRESOLVED ISSUES

There are a number of issues that cannot be resolved with certainty based on the information presently available. The discussions below summarize the unresolved issues.

FUNDING

The source of funds for the proposed capital improvements is a major unresolved issue. Currently, the Waimanalo Wastewater Treatment Plant (WWTP) is owned by the State of Hawaii, and operated and maintained by the City and County of Honolulu. The City Department of Environmental Services and the State Department of Land and Natural Resources are currently negotiating to resolve wastewater facility financing, management and ownership issues. A likely outcome of the negotiations appears to be a scenario in which the State funds most of the required improvements in exchange for the City accepting permanent ownership and responsibility for the facilities.

Financing and cost sharing issues for additional facilities to produce and convey reclaimed water are also unresolved among the potential water users and various government agencies.

The funds required for construction may vary depending on the final design and extent of the Waimanalo WWTP and sewer upgrade work, bidding conditions, and other factors.

CONSTRUCTION TIMETABLE

The construction schedule for the majority of the proposed facilities is unresolved as it will be largely dependent on the availability of funding for the improvements.

KOOLAUPOKO DEVELOPMENT PLAN REVISIONS

The recommended sizing of treatment facilities is potentially subject to reevaluation during the engineering design phase due to revisions to the Koolaupoko Development Plan that are expected to be completed in late 1998.

FLOODING

The 100-year flood elevations at the Waimanalo WWTP may potentially be increased in the future based on a recently completed flood study. The extent and timetable for

the flood elevation revisions are uncertain. It is also uncertain whether downstream flood control projects to reduce the flooding impacts will be initiated in the future.

WATER QUALITY IMPACTS FROM INDIVIDUAL WASTEWATER SYSTEM IN COASTAL AREAS AND THE WAIMANALO WWTP

The extent of public health and water quality benefits of installing sewers to eliminate the use of individual wastewater systems in the low-lying coastal areas is uncertain at the present time. Groundwater investigations and technical literature indicate that pathogens from the individual wastewater systems are likely to be effectively removed by the sandy soil in the coastal areas. The discharge of nitrogen in the form of soluble nitrates, however, is a concern. There is also some concern with treated effluent from the Waimanalo WWTP injection wells surfacing in the nearshore region.

Additional investigations to address the above concerns and to quantify and assess other sources of nutrients in the Waimanalo watershed are recommended. Members of the Waimanalo community are attempting to secure funds for these additional studies through the Kailua Bay Advisory Council (KBAC). The KBAC is responsible for appropriating funds for projects to improve the water quality in the Waimanalo, Kailua and Kaneohe watersheds. The funds are from a consent decree for a lawsuit on City and County of Honolulu wastewater facilities in Windward Oahu. A budget of \$150,000 is proposed for the studies in the Waimanalo Facilities Plan. The budget for the studies may vary considerably depending on the scope of the investigations conducted and availability of funding.

USE OF RECLAIMED WATER FOR IRRIGATION

The extent to which reclaimed water will be used for irrigation is uncertain. The Olomana Golf Links will likely require funding from other sources for the effluent transmission facilities in order for the use of *reclaimed* water to be cost-effective. The extent of irrigation of the agricultural farm lots with reclaimed water may be slightly reduced by restrictions imposed by the Honolulu Board of Water Supply to protect its drinking water sources. The extent of farm lot irrigation will also be dependent on the pricing structure of the reclaimed water and the cost-effectiveness of bringing additional land into production in areas experiencing water shortages.

The proposed future reclaimed water projects in Waimanalo should be incorporated into the Oahu Water Management Plan and coordinated among the various entities involved in water resource planning.

BENEFICIAL REUSE OF WASTEWATER SLUDGE

The future of the City's managed beneficial reuse program for its wastewater sludge is uncertain at the present time. The establishment of a centralized biosolids processing facility has been not yet been implemented due to lack of an acceptable site. Although the establishment of a regional sludge processing facility to handle sludge generated in Windward Oahu is a possibility, the Waimanalo WWTP is not a recommended site for the facility.

Chapter 10

Organizations and Persons Consulted

CHAPTER 10

ORGANIZATIONS AND PERSONS CONSULTED

A key element in the environmental review process is the solicitation of input from government agencies, community organizations, and the general public. Input provided by various organizations and individuals consulted during the preparation of this *Final Supplemental Environmental Impact Statement (FSEIS)*, the Draft Supplemental Environmental Impact Statement (DSEIS) and the SEIS Preparation Notice (SEISPN) is presented in this chapter. *A public hearing was held following the distribution of the DSEIS and transcripts of the meeting are included in this chapter.* A summary of public input received during preparation of the Waimanalo Wastewater Facilities Plan is also included. A list of firms and key individuals involved in the preparation of the DSEIS, SEIS Preparation Notice, and Waimanalo Wastewater Facilities Plan is presented at the end of this chapter.

LIST OF ORGANIZATIONS/PERSONS CONSULTED FOR THE DSEIS AND COPIES OF SEISPN COMMENT/RESPONSE LETTERS

The following organizations and persons were consulted in preparation of *the Draft Supplemental EIS*. Those marked with an asterisk (*) sent written comments on the Supplemental EIS Preparation Notice. The new names of the City and County of Honolulu agencies following the recent reorganization are shown in parentheses. The letters and responses are reproduced on the pages which follow in the order listed below.

City and County of Honolulu

- Council Member John Henry Felix, District III
- Board of Water Supply*
- Building Department* (now Department of Design and Construction)
- Department of Housing and Community Development* (department dissolved)
- Department of Land Utilization* (Department of Planning and Permitting)
- Department of Parks and Recreation* (Dept. of Parks and Recreation Services)
- Planning Department*
- Department of Public Works* (Department of Facility Maintenance)
- Department of Transportation Services*
- Fire Department*
- Police Department*

State of Hawaii

9/14 Check letters
in file - OK
C:\M\ENV\...
025

CHAPTER 10

ORGANIZATIONS AND PERSONS CONSULTED

A key element in the environmental review process is the solicitation of input from government agencies, community organizations, and the general public. Input provided by various organizations and individuals consulted during the preparation of this *Final Supplemental Environmental Impact Statement (FSEIS)*, the Draft Supplemental Environmental Impact Statement (DSEIS) and the SEIS Preparation Notice (SEISPN) is presented in this chapter. *A public hearing was held following the distribution of the DSEIS and transcripts of the meeting are included in this chapter.* A summary of public input received during preparation of the Waimanalo Wastewater Facilities Plan is also included. A list of firms and key individuals involved in the preparation of the DSEIS, SEIS Preparation Notice, and Waimanalo Wastewater Facilities Plan is presented at the end of this chapter.

LIST OF ORGANIZATIONS/PERSONS CONSULTED FOR THE DSEIS AND COPIES OF SEISPN COMMENT/RESPONSE LETTERS

The following organizations and persons were consulted in preparation of *the Draft Supplemental EIS*. Those marked with an asterisk (*) sent written comments on the Supplemental EIS Preparation Notice. The new names of the City and County of Honolulu agencies following the recent reorganization are shown in parentheses. The letters and responses are reproduced on the pages which follow in the order listed below.

City and County of Honolulu

- Council Member John Henry Felix, District III
- Board of Water Supply*
- Building Department* (now Department of Design and Construction)
- Department of Housing and Community Development* (department dissolved)
- Department of Land Utilization* (Department of Planning and Permitting)
- Department of Parks and Recreation* (Dept. of Parks and Recreation Services)
- Planning Department*
- Department of Public Works* (Department of Facility Maintenance)
- Department of Transportation Services*
- Fire Department*
- Police Department*

State of Hawaii

Senator Whitney Anderson, District 25
Representative Kenny Goodenow, District 51

State of Hawaii (continued)

Department of Agriculture
Department of Defense
Department of Hawaiian Home Lands*
Department of Health, Environmental Planning Office
Department of Health, Environmental Management Division
Department of Land and Natural Resources, Land Division*
Department of Land and Natural Resources, Division of Aquatic Resources* (see
Land Division correspondence)
Department of Land and Natural Resources, Commission on Water Resources
Management* (see Land Division correspondence)
Department of Land and Natural Resources, Water and Land Development
Division
Department of Land and Natural Resources, State Historic Preservation Division
Department of Land and Natural Resources, State Parks Division*
Hawaii Housing Authority
Housing and Finance Development Corporation*
Office of Environmental Quality Control*
Office of State Planning; Department of Business, Economic Development
and Tourism*
Office of Hawaiian Affairs*
University of Hawaii, Environmental Center
University of Hawaii, Water Resources Research Center
Waimanalo Library

U.S. Government

Department of Agriculture, Natural Resources Conservation Service*
Department of the Army, U.S. Army Engineer District*
Department of the Navy
Department of Interior, Fish and Wildlife Service
Department of Interior, Geological Survey, Water Resources Division
Bellows Air Force Station
Marine Corps Base Hawaii
U.S. Environmental Protection Agency, Region IX

Community Groups and Organizations, Other Interested Parties

Waimanalo Neighborhood Board No. 32
Waimanalo Neighborhood Board, Wastewater Advisory Committee
Waimanalo Hawaiian Homestead Association
Waimanalo Homes Residents Association
Olomana Golf Links

Kailua Bay Advisory Council
Waimanalo Water Quality Committee, c/o The Hawaii Community Foundation

Community Groups and Organizations, Other Interested Parties (continued)

Kailua Neighborhood Board, Planning and Zoning Committee*
Save Our Bays and Beaches
Hilltop Equestrian Centre*
Waimanalo News
The Honolulu Advertiser

Public Utility Agencies

GTE Hawaiian Telephone*
Hawaiian Electric Company*

BOARD OF WATER SUPPLY

CITY AND COUNTY OF HONOLULU
632 SOUTH BERETANIA STREET
HONOLULU, HAWAII 96843
PHONE (808) 527-6180
FAX (808) 533-2714



March 31, 1998

STRENGTH & INTEGRITY
WALTERO, LESTER, JR., Chairman
EDDIE FLORES, II
KAZUHIKO
JANUARY 20
FOREST C. HENRY
LOUANNICK, Executive Director
SARAHANNA, Director
SANDOROH, Director
WALTERO, LESTER, JR., Chairman
EDDIE FLORES, II
KAZUHIKO
JANUARY 20
FOREST C. HENRY
LOUANNICK, Executive Director
SARAHANNA, Director
SANDOROH, Director

Mr. Roy K. Abe, Vice President
Hawaii Pacific Engineers, Inc.
1132 Bishop Street, Suite 1003
Honolulu, Hawaii 96813-2830

Dear Mr. Abe:

Subject: Your Transmittal of February 3, 1998 of the Supplemental Environmental Impact Statement Preparation Notice for the Waimanalo Wastewater Facilities Plan, Waimanalo, Oahu, TMK: 4-1

Thank you for the opportunity to review the environmental document for the facilities plan update.

We have the following comments to offer:

1. The existing off-site water system is presently adequate to accommodate the proposed Waimanalo treatment plant upgrade. However, the system cannot provide adequate fire protection to the Kahawai pump station site. The Department of Wastewater Management is required to install a fire hydrant in the vicinity of the pump station.
2. The construction plans for the fire hydrant and the wastewater facilities plan should be submitted for our review and approval.
3. The availability of water will be determined when the Building Permit Applications are submitted for our review and approval. If water is made available, the applicant will be required to pay our Water System Facilities Charges for resource development, transmission and daily storage.
4. We support the proposal to produce reclaimed water for irrigation purposes. However, there is one objection to the current proposal regarding the mauka portion of Site 5 (Wong-TMK: 4-1-08-79). This area is located within the No Pass Zone where use of treated effluent has the potential to contaminate the underlying potable groundwater aquifer. This parcel is also in close proximity to our Waimanalo Well III which replaces our Waimanalo Well I. Because of our source contamination experience, we are concerned if this area were irrigated with treated effluent.
5. The Draft Environmental Impact Statement (DEIS) should therefore clarify the level of treatment the irrigation effluent will receive and address the health impacts associated with reuse. It should also include a discussion on mitigative measures which would be implemented should contamination of the potable groundwater aquifer occur.

There are existing 3 and 1 1/2-inch water meters serving the treatment plant and pump station, respectively.

Pure Water... our greatest need - use it wisely

Pure Water... man's greatest need - use it wisely

Mr. Roy K. Abe
Page 2
March 31, 1998

6. If additional 3-inch or larger water meters are required, the construction drawings showing the installation of the meters should be submitted for our review and approval.
7. The on-site fire protection requirements should be coordinated with the Fire Prevention Bureau of the Honolulu Fire Department.
8. Board of Water Supply Approved Reduced Pressure Principle Backflow Prevention Assemblies are required installations immediately after all water meters serving the wastewater facility sites.
9. The conceptual aquifer diagram shown in Figure III-1 should include a tunnel tapping the high level dike water. In addition to our Waimanalo Well II source, Figure III-2 should include our Waimanalo Tunnels I, II, III, IV and Well III. The tunnels are currently in production and Waimanalo Well III will be a future source. We have attached revised sketches of Figures III-1 and 2 showing the dike tunnel, existing tunnel sources and future well.

If you have any questions, please contact Darryl Usagawa at 527-5235.

Very truly yours,

FOR RAYMOND L. SATO
Manager and Chief Engineer

Attachments

cc: Department of Wastewater Management

DATE: 01/01/78 PW: 44
 SCALE: 1" = 4000' OPER: 344
 FILE: 9331-00 REVISED: 01/27/78

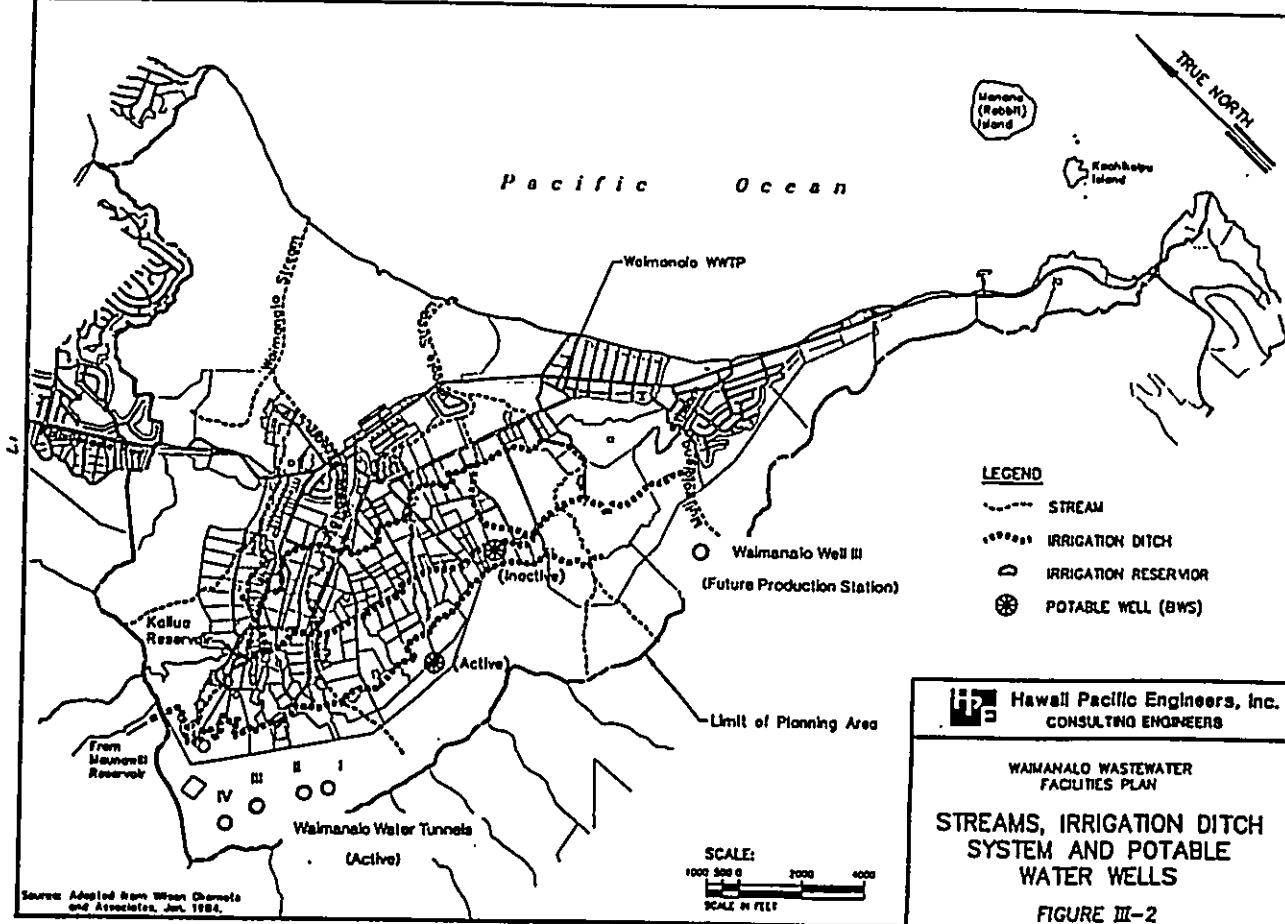

DATE: 01/01/78 PW: 45
 SCALE: 1" = 1500' OPER: 344
 FILE: 9331-01 REVISED: -

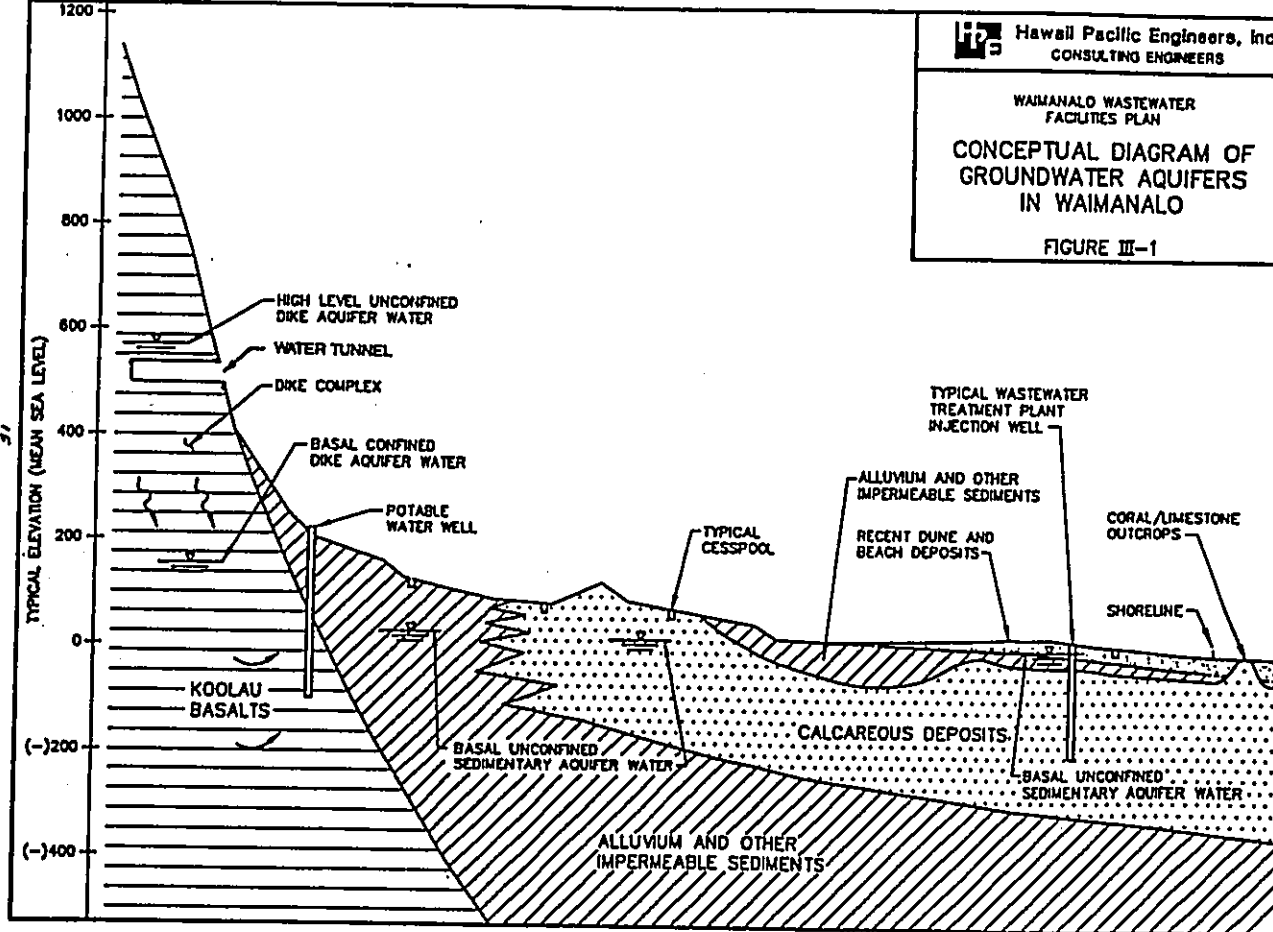

DEPARTMENT OF WASTEWATER MANAGEMENT
CITY AND COUNTY OF HONOLULU
450 SOUTH KING STREET
HONOLULU HAWAII 96813



JEROME HARRIS
CHIEF

KENNETH E. SPRAGUE, P.E., Ph.D.
DIRECTOR
CIVIL & ENVIRONMENTAL ENGINEERING
CONSULTANTS

WPP 98-225

April 20, 1998

MEMORANDUM

TO: MR. BROOKS YUEN, ACTING MANAGER AND CHIEF ENGINEER
BOARD OF WATER SUPPLY

FROM: KENNETH E. SPRAGUE, DIRECTOR
DEPARTMENT OF WASTEWATER MANAGEMENT
CIVIL & ENVIRONMENTAL ENGINEERING
CONSULTANTS

SUBJECT: SUPPLEMENTAL ENVIRONMENTAL IMPACT STATEMENT
PREPARATION NOTICE FOR WAIMANALO WASTEWATER
FACILITIES PLAN, KOOLAUPOKO, OAHU, HAWAII

Thank you for your letter of March 31, 1998 to Hawaii Pacific Engineers, Inc. regarding the subject project. We would like to take this opportunity to respond to your specific comments.

The installation of a new fire hydrant will be proposed at the Kahawai Stream Wastewater Pump Station as recommended. Construction plans for the water system upgrade work at the pump station and the Waimanalo Wastewater Treatment Plant (WWTP) will be submitted to the Board of Water Supply (BWS) for review and approval. We anticipate that the existing 3- and 1-1/2-inch meters serving the treatment plant and pump station will be adequate. However, a new separate 10-inch fire protection line with detector check is proposed to supply fire hydrants within the treatment plant site. The on-site fire protection requirements will be coordinated with the Honolulu Fire Department. New BWS approved reduced pressure principle backflow prevention units will be provided as required immediately downstream of the water meter.

The proposed level of treatment for the reclaimed water is "R-1," which is the highest level of treatment under current State of Hawaii Department of Health (DOH) effluent reuse regulations and guidelines. Despite the high level of treatment, it is our understanding that BWS is still concerned with possible leaching of total dissolved solids and other contaminants into the potable water supply. It is also our understanding that DOH has taken a less conservative stance in which the

Mr. Brooks Yuen

-2-

April 20, 1998

use of reclaimed water in the "no-pass" zone is acceptable if certain requirements are met. The contamination concerns and possible mitigative measures will be discussed in the Draft Supplemental Environmental Impact Statement (DSEIS). We will clearly indicate that the use of reclaimed water may not be permitted by BWS in the mauka "no-pass" portion of the Wong property. We will further indicate that this is currently an unresolved issue which will require further investigation on a case specific basis.

Diagrams in the DEIS pertaining to potable water sources will show the Waimanalo Tunnels that are currently in use and the new Waimanalo Well III that will be operational in the near future. Thank you very much for furnishing us this information.

We will be providing you with a copy of the DSEIS upon its completion. We look forward to your agency's continued participation as a consulted party. If there are any questions, please feel free to contact me or either one of our project engineers, Mr. Carl Arakaki at 523-4671, or Mr. Robert Miyasaki at 527-5159. Thank you very much for your interest in this project.

cc: Hawaii Pacific Engineers, Inc.

BUILDING DEPARTMENT
CITY AND COUNTY OF HONOLULU
HONOLULU MUNICIPAL BUILDING
430 SOUTH KING STREET
HONOLULU, HAWAII 96813

RECEIVED
APR 9 - 1998



BANDALL K. FUJIKI
DIRECTOR AND BUILDING SUPERINTENDENT
JEREMY HARRIS
MAYOR

PB 98-129

March 3, 1998

Mr. Roy K. Abe, Vice President
Hawaii Pacific Engineers, Inc.
1132 Bishop Street, Suite 1003
Honolulu, Hawaii 96813-2830

Dear Mr. Abe:

Subject: Supplemental Environmental Impact Statement Preparation Notice for
Waimanalo Wastewater Facilities Plan, Koolauopoko, Oahu, Hawaii

This is in response to your request of February 3, 1998 to review and comment on the subject material.

We have no comments to offer but appreciate the opportunity to review the document. Should there be any questions, please contact Douglas Collinson at 527-6375.

Very truly yours,

Bandall K. Fujiki
FOR RANDALL K. FUJIKI
Director and Building Superintendent

DEPARTMENT OF WASTEWATER MANAGEMENT
CITY AND COUNTY OF HONOLULU
430 SOUTH KING STREET
HONOLULU, HAWAII 96813

RECEIVED
APR 15 1998



KENNETH E. SPRAGUE, P.E.
DIRECTOR
CHERYL OKUMA-SUPE, ASCE
DEPUTY DIRECTOR

HAWAII PACIFIC ENGINEERS INC.

April 8, 1998

WPP 98-191

TO: MR. RANDALL K. FUJIKI, DIRECTOR AND BUILDING SUPERINTENDENT
BUILDING DEPARTMENT

FROM: KENNETH E. SPRAGUE, DIRECTOR *CS*
DEPARTMENT OF WASTEWATER MANAGEMENT

SUBJECT: SUPPLEMENTAL ENVIRONMENTAL IMPACT STATEMENT PREPARATION
NOTICE FOR WAIMANALO WASTEWATER FACILITIES PLAN
KOOLAUPOKO, OAHU, HAWAII

Thank you for your letter of March 3, 1998 to Hawaii Pacific Engineers, Inc. regarding the subject project.

We will provide you with a copy of the Draft Supplemental Environmental Impact Statement (DSEIS) upon its completion. We look forward to your agency's continued participation as a consulted party. If there are any questions, please feel free to contact me or either of our project engineers, Mr. Carl Arakaki at 523-4671, or Mr. Robert Miyasaki at 527-5139. Thank you for your interest in this project.

cc: Hawaii Pacific Engineers, Inc.

DEPARTMENT OF LAND UTILIZATION
CITY AND COUNTY OF HONOLULU
RECEIVED
MAR 04 1998

435 SOUTH KING STREET, 21ST FLOOR, HONOLULU, HAWAII 96813
PHONE: (808) 525-4414 • FAX: (808) 527-8723



RECEIVED
DATE

JANUARY SULLIVAN
DIRECTOR
HAWAII PACIFIC
ENGINEERS INC.

JANUARY SULLIVAN
DIRECTOR

LORETTA K. CHIE
SENIOR ENGINEER

98-00920(ST)
'98 EA Comments Zone 4

March 3, 1998

Mr. Roy K. Abe, Vice-President
Hawaii Pacific Engineers, Inc.
1132 Bishop Street, Suite 1003
Honolulu, Hawaii 96813-2830

Dear Mr. Abe:

Supplemental Environmental Impact Statement Preparation Notice
(SEISPN): Waimanalo Wastewater Facilities Plan,
Waimanalo, Oahu
Tax Map Keys: 4-1-3 various

We have reviewed the SEISPN for the above-referenced plan transmitted by your letter dated February 3, 1998, and provide the following comments:

- Portions of several collection areas planned for improvement are located within the Special Management Area (SMA). The Draft Supplemental Environmental Impact Statement (EIS) should include an exhibit illustrating the plan area relative to the SMA boundaries.
- Although the development of new wastewater collection systems will require the approval of an SMA Use Permit, improvements and alterations to existing above- and below-ground facilities within existing utility corridors are exempt from SMA requirements pursuant to Section 25-1.3(2)(D), Revised Ordinances of Honolulu.

We have no other comments to offer at this time. However, we do look forward to reviewing the Draft Supplemental EIS when it is completed.

Mr. Roy K. Abe, Vice-President
Page 2
March 3, 1998

Thank you for the opportunity to comment on this document. Should you have any questions, please contact Steve Tagawa of our staff at 523-4817.

Very truly yours,

JAN MARIE SULLIVAN
Director of Land Utilization

JNS:am

cc: Department of Wastewater Management

g:\ppd\soispnw.sht

DEPARTMENT OF WASTEWATER MANAGEMENT
CITY AND COUNTY OF HONOLULU
630 SOUTH KING STREET
HONOLULU, HAWAII 96813



KENNETH E. SPRAGUE, P.E., Ph.D.
DIRECTOR
CHERYL K. O'NEAL, SEP. ESQ.
DEPUTY DIRECTOR

JEREMY HARRIS
ATTORNEY

WPP 98-193

April 8, 1998

TO: MS. JAN MAOE SULLIVAN, DIRECTOR
DEPARTMENT OF LAND UTILIZATION

FROM: KENNETH E. SPRAGUE, DIRECTOR
DEPARTMENT OF WASTEWATER MANAGEMENT
CHERYL K. O'NEAL, SEP. ESQ.

SUBJECT: SUPPLEMENTAL ENVIRONMENTAL IMPACT STATEMENT PREPARATION
NOTICE FOR WAIMANALO WASTEWATER FACILITIES PLAN
KOOLAUPOKO, OAHU, HAWAII

Thank you for your letter of March 3, 1998, to Hawaii Pacific Engineers, Inc. regarding the subject project.

As recommended by your comments, the Draft Supplemental Environmental Impact Statement (DSEIS) will include an exhibit indicating the SMA boundaries relative to the areas proposed for collection system improvements.

We will provide you with a copy of the DSEIS upon its completion. We look forward to your agency's continued participation as a consulted party. If there are any questions, please feel free to contact me or either one of our project engineers, Mr. Carl Arakaki at 523-4671, or Mr. Robert Miyasaki at 527-5159. Thank you for your interest in this project.

cc: Hawaii Pacific Engineers, Inc.



DEPARTMENT OF WASTEWATER MANAGEMENT
CITY AND COUNTY OF HONOLULU
 430 SOUTH KING STREET
 HONOLULU, HAWAII 96813

KENNETH E. SPRAGUE, P.E.
 DIRECTOR
 CHEVYLE GRAMA BEPE, ESQ.
 DEPUTY DIRECTOR



WPP 98-227

April 20, 1998

98-0513
 PIC
 48-422-0

DEPARTMENT OF PARKS AND RECREATION
CITY AND COUNTY OF HONOLULU
 430 SOUTH KING STREET, ROOM 4102, HONOLULU, HAWAII 96813
 PHONE: (808) 525-8182 • FAX: (808) 525-4034

WILLIAM D. BALFOUR, JR.
 DIRECTOR
 MICHAEL T. JAHN
 DEPUTY DIRECTOR



March 9, 1998

RECEIVED
 88 MAR 10 PM 4:32

DEPT. OF
 WASTEWATER
 MANAGEMENT

MEMORANDUM

TO: MR. WILLIAM D. BALFOUR, JR., DIRECTOR
 DEPARTMENT OF PARKS AND RECREATION

FROM: KENNETH E. SPRAGUE, DIRECTOR
 DEPARTMENT OF WASTEWATER MANAGEMENT
 CHEVYLE K. GRAMA BEPE

SUBJECT: SUPPLEMENTAL ENVIRONMENTAL IMPACT STATEMENT
 PREPARATION NOTICE FOR WAIMANALO WASTEWATER
 FACILITIES PLAN, KOOLAUPOKO, OAHU, HAWAII

TO: KENNETH E. SPRAGUE, DIRECTOR
 DEPARTMENT OF WASTEWATER MANAGEMENT

FROM: WILLIAM D. BALFOUR, JR., DIRECTOR

SUBJECT: SUPPLEMENTAL ENVIRONMENTAL IMPACT STATEMENT
 PREPARATION NOTICE, FOR THE WAIMANALO WASTEWATER
 FACILITIES PLAN, KOOLAUPOKO, OAHU, HAWAII

We have reviewed the Waimanalo Wastewater Facilities Plan Supplemental Environmental Impact Statement Preparation Notice (SEISPN) transmitted by a memorandum dated January 28, 1998 from your consultant, Hawaii Pacific Engineers, Inc. The proposed project is expected to have no significant impact on our parks; however, we would like to continue to be a consulted party during the remainder of the EIS review process. Please call Mr. Jay Lembeck, planner in our Advance Planning Branch, at extension 4272, if you have any questions.

Thank you for your letter of March 9, 1998 regarding the subject project. We will be providing you with a copy of the Draft Supplemental Environmental Impact Statement (DSEIS) upon its completion. We look forward to your agency's continued participation as a consulted party. If there are any questions, please feel free to contact me or either one of our project engineers, Mr. Carl Atakaki at 523-4671, or Mr. Robert Miyasaki at 527-5159. Thank you very much for your interest in this project.

W.D. Balfour, Jr.
 WILLIAM D. BALFOUR, JR.
 Director

cc: Hawaii Pacific Engineers, Inc. ✓

WDB:el

RECEIVED
FEB 27 1998
PLANNING DEPARTMENT
CITY AND COUNTY OF HONOLULU
930 SE 4TH KING STREET 8TH FLOOR • HONOLULU, HAWAII 96813-3017
PHONE (808) 523-4533 • FAX (808) 523-4850

HAWAII PACIFIC
ENGINEERS INC.
JEREMY HARRIS
VICE



PATRICK ONISHI
CHIEF PLANNING OFFICER
DONALD HARRIS
DEPUTY CHIEF PLANNING OFFICER

RR 2/98-0227

JEREMY HARRIS
VICE

DEPARTMENT OF WASTEWATER MANAGEMENT
CITY AND COUNTY OF HONOLULU
400 SE 4TH KING STREET
HONOLULU, HAWAII 96813



KENNETH E. SPRAGUE, P.E., P.
DIRECTOR
CERIEL K. OKUMA, P.E., P.
DEPUTY DIRECTOR

February 25, 1998

Mr. Roy K. Abe, Vice President
Hawaii Pacific Engineers, Inc.
1132 Bishop Street, Suite 1003
Honolulu, Hawaii 96813-2830

Dear Mr. Abe:

Supplemental Environmental Impact Statement
Preparation Notice for
Waimanalo Wastewater Facilities Plan Koolauopoko, Oahu, Hawaii

We are responding to your letter dated February 3, 1998 requesting comments on the above notice. We have reviewed the Preparation Notice with regards to the proposed project's General Plan and Development Plan impacts for the Koolauopoko area. In this regard, we recommend that the supplemental EIS address any potential conflicts the Waimanalo Wastewater Facilities Plan may pose for the City and County of Honolulu's General Plan and its Koolauopoko Development Plan.

The Planning Department is currently working on a major revision of the Koolauopoko Development Plan. To the degree possible the Supplemental EIS should address possible changes in the Koolauopoko Development Plan that may affect the Waimanalo Wastewater Facilities Plan. Please contact Mr. Gordon Wood of our staff at 527-6073 who is the project manager of the Koolauopoko Development Plan Revision program to coordinate the preparation of the Supplemental EIS.

Should you have any questions, please contact Robert Reed of our staff at 523-4402.

Yours very truly,

PATRICK T. ONISHI
Chief Planning Officer

PTO:lh

April 8, 1998

WPP 98-194

TO: MR. PATRICK T. ONISHI, CHIEF PLANNING OFFICER
PLANNING DEPARTMENT

FROM: KENNETH E. SPRAGUE, DIRECTOR
DEPARTMENT OF WASTEWATER MANAGEMENT

SUBJECT: SUPPLEMENTAL ENVIRONMENTAL IMPACT STATEMENT PREPARATION
NOTICE FOR WAIMANALO WASTEWATER FACILITIES PLAN
KOOLOAPOKO, OAHU, HAWAII

Thank you for your letter of February 25, 1998, to Hawaii Pacific Engineers, Inc. regarding the subject project.

As recommended by your comments, the Draft Supplemental Environmental Impact Statement (DSEIS) will address and attempt to minimize potential conflicts between the Waimanalo Wastewater Facilities Plan and the City and County of Honolulu's General Plan and its Koolauopoko Development Plan. We will incorporate information on the proposed revisions to the Koolauopoko Development Plan that is available prior to the targeted mid-year completion of our project. It should be noted that the wastewater facilities plan serves as a general master planning document for major wastewater infrastructure. There will be opportunities to adjust the design flows, treatment capacities, and construction phasing during subsequent detailed planning and engineering phases of the project.

We will provide you with a copy of the DSEIS upon its completion. We look forward to your agency's continued participation as a consulted party. If there are any questions, please feel free to contact me or either one of our project engineers, Mr. Carl Arakaki at 523-4671, or Mr. Robert Miyasaki at 527-5159. Thank you for your interest in this project.

cc: Hawaii Pacific Engineers, Inc.

DEPARTMENT OF PUBLIC WORKS
CITY AND COUNTY OF HONOLULU
830 SOUTH KING STREET, 11TH FLOOR • HONOLULU, HAWAII 96813
PHONE: (808) 525-3251 • FAX: (808) 527-9857



JEREMY HARRIS
MAYOR

HAWAII PACIFIC
ENGINEERS INC.
JOHN HANEY BOWEN, P.E.
DIRECTOR AND CHIEF ENGINEER
ROLAND LARRY JR.
SENIOR DIRECTOR
ENV 98-047

FEB 27 1998

DEPARTMENT OF WASTEWATER MANAGEMENT
CITY AND COUNTY OF HONOLULU
830 SOUTH KING STREET
HONOLULU, HAWAII 96813



STIMME, SPANGLER, P.E., P.C.
SECTION
CIVIL & ENVIRONMENTAL
ENGINEERING

WPP 98-196

February 20, 1998

April 8, 1998

MEMORANDUM:

TO: KENNETH E. SPRAGUE, DIRECTOR
DEPARTMENT OF WASTEWATER MANAGEMENT

FROM: JONATHAN K. SHIMADA, PND
DIRECTOR AND CHIEF ENGINEER *Jonathan Shimada*

SUBJECT: SUPPLEMENTAL ENVIRONMENTAL IMPACT STATEMENT
PREPARATION NOTICE (SEISPN)
WAIMANALO WASTEWATER FACILITIES PLAN
THK: 4-1

TO: DR. JONATHAN K. SHIMADA, DIRECTOR AND CHIEF ENGINEER
DEPARTMENT OF PUBLIC WORKS

FROM: KENNETH E. SPRAGUE, DIRECTOR
DEPARTMENT OF WASTEWATER MANAGEMENT
Ken Sprague

SUBJECT: SUPPLEMENTAL ENVIRONMENTAL IMPACT STATEMENT PREPARATION
NOTICE FOR WAIMANALO WASTEWATER FACILITIES PLAN
KOOLAUPOKO, OAHU, HAWAII

We have reviewed the subject SEISPN and have the following comments:

- III.A.3. Streams: The SEISPN should provide general descriptions and identify ownership of the major streams in the area (Waimanalo Stream, Inoaole Stream and Muliwaiole Stream).
- III.A.1. Water Quality and Public Health Protection: The SEISPN should describe best management practices (BMPs) to reduce discharge of pollutants to the drainage system (containment of chemicals, vehicle and equipment washing, procedures for local spills in the wastewater facilities).

Should you have any questions, please contact Alex Ho at Local 4150.

cc: Hawaii Pacific Engineers, Inc. (Roy Abe)

Thank you for your memorandum of February 20, 1998, regarding the subject project.

As recommended by your comments, the Draft Supplemental Environmental Impact Statement (SEIS) will provide general descriptions and identify ownership of major streams in the Waimanalo area. The SEIS will also briefly describe Best Management Practices (BMPs) that can be employed to reduce discharges to drainage systems and the impacts of other non-point sources of pollution.

We will provide you with a copy of the SEIS upon its completion. We look forward to your agency's continued participation as a consulted party. If there are any questions, please feel free to contact me or either one of our project engineers, Mr. Carl Arakaki at 523-4671, or Mr. Robert Miyasaki at 527-5159. Thank you for your interest in this project.

cc: Hawaii Pacific Engineers, Inc.

RECEIVED
MAR 13 1998
DEPARTMENT OF TRANSPORTATION SERVICES
AND COUNTY OF HONOLULU
PHONE 521-2233 FAX 521-2233
HONOLULU HAWAII 96813

HAWAII PACIFIC
ENGINEERS INC.

JEREMY HARRIS
DIRECTOR



CHERYL D. SOON
DIRECTOR
DEPARTMENT OF WASTEWATER MANAGEMENT

JEREMY HARRIS
DIRECTOR

DEPARTMENT OF WASTEWATER MANAGEMENT
CITY AND COUNTY OF HONOLULU
SECTION MANAGER
HONOLULU HAWAII 96813



KENNETH E. SPRAGUE
DIRECTOR
DEPARTMENT OF WASTEWATER MANAGEMENT

March 10, 1998

TSP2/98-00687R

WPP 98-197

Mr. Roy K. Abe, Vice President
Hawaii Pacific Engineers, Inc.
1132 Bishop Street, Suite 1003
Honolulu, Hawaii 96813-2830

Dear Mr. Abe:

Subject: Waimanalo Wastewater Facilities Plan

In response to your February 3, 1998 letter, the supplemental environmental impact statement (EIS) preparation notice for the subject project was reviewed. While we have no objections to the project, construction plans, including traffic control plans, for all work within the City's right-of-way should be submitted to this department for review and approval as they become available.

We look forward to continuing as a consulted party during the remainder of the EIS review process.

Should you have any questions regarding this matter, please contact Faith Miyamoto of the Transportation System Planning Division at 527-6976.

Sincerely,

CHERYL D. SOON
Director

cc: Dr. Kenneth Sprague,
Department of Wastewater Management

April 8, 1998

TO: MS. CHERYL D. SOON, DIRECTOR
DEPARTMENT OF TRANSPORTATION SERVICES

FROM: KENNETH E. SPRAGUE, DIRECTOR
DEPARTMENT OF WASTEWATER MANAGEMENT

SUBJECT: SUPPLEMENTAL ENVIRONMENTAL IMPACT STATEMENT PREPARATION
NOTICE FOR WAIMANALO WASTEWATER FACILITIES PLAN
KOOLAUPOKO, OAHU, HAWAII

Thank you for your letter of March 10, 1998, to Hawaii Pacific Engineers, Inc. regarding the subject project.

Construction plans, including traffic control plans, for work within the City's right-of-way will be submitted for review and approval during the design phase of the project.

We will provide you with a copy of the Draft Supplemental Environmental Impact Statement (DSEIS) upon its completion. We look forward to your agency's continued participation as a consulted party. If there are any questions, please feel free to contact me or either one of our project engineers, Mr. Carl Arakaki at 523-4671, or Mr. Robert Miyasaki at 527-5159. Thank you for your interest in this project.

cc: Hawaii Pacific Engineers, Inc.

FIRE DEPARTMENT
CITY AND COUNTY OF HONOLULU
3335 COMPARA STREET, SUITE 4023
HONOLULU, HAWAII 96819-1803



JEREMY HARRIS
BATTALION CHIEF

ANTHONY J. LOPEZ, JR.
FIRE CHIEF
ASTORIO K. LEONARD
FIRE DEPUTY CHIEF

February 12, 1998

Mr. Roy K. Abe
Vice President
Hawaii Pacific Engineers, Inc.
1132 Bishop Street, Suite 1003
Honolulu, Hawaii 96813-2630

Dear Mr. Abe:

Subject: Supplemental Environmental Impact Statement Preparation Notice for
Waimanalo Wastewater Facilities Plan, Koolauopoko, Oahu, Hawaii
HFD Internal No. 98-042

We have reviewed the subject material provided and foresee no adverse impact in Fire Department facilities or services. Access for fire apparatus, water supply and building construction shall be in conformance to existing codes and standards.

The recommended use of ultraviolet effluent disinfection in lieu of chlorination has our full support. Any reduction in the transportation and handling of chlorine gas increases overall safety for plant personnel, the adjacent community, as well as first responders, such as ourselves.

Should you have any questions, please call Battalion Chief Charles Wassman of our Fire Prevention Bureau at 831-7778.

Sincerely,

ANTHONY J. LOPEZ, JR.
Fire Chief

AJL:mpn

DEPARTMENT OF WASTEWATER MANAGEMENT
CITY AND COUNTY OF HONOLULU
430 SOUTH KING STREET
HONOLULU, HAWAII 96813



JEREMY HARRIS
BATTALION CHIEF

EMMETTE SMAGALSKI
DIRECTOR
CHESTER L. OLIVER, JR.
DEPUTY DIRECTOR

April 8, 1998

MPP 98-192

TO: ANTHONY J. LOPEZ, JR., FIRE CHIEF
HONOLULU FIRE DEPARTMENT

FROM: KENNETH E. SPRAGUE, DIRECTOR
DEPARTMENT OF WASTEWATER MANAGEMENT

SUBJECT: SUPPLEMENTAL ENVIRONMENTAL IMPACT STATEMENT PREPARATION
NOTICE FOR WAIMANALO WASTEWATER FACILITIES PLAN
KOOLOAUPOKO, OAHU, HAWAII

Thank you for your letter of February 12, 1998, to Hawaii Pacific Engineers, Inc. regarding the subject project.

Please be assured that access for fire apparatus, water supply, and building construction for the upgraded facilities will be in conformance to existing codes and standards.

Should you desire any additional information on the project, feel free to contact me or either of our project engineers, Mr. Carl Arakaki at 523-4671, or Mr. Robert Miyasaki at 527-5159.

cc: Hawaii Pacific Engineers, Inc.

RECEIVED
FEB 17 1998
POLICE DEPARTMENT
CITY AND COUNTY OF HONOLULU
801 SOUTH BERTAMIA STREET
HONOLULU, HAWAII 96813 - AREA CODE (808) 528-3111

HAWAII PACIFIC
ENGINEERS INC.
JEREMY HARRIS
MAYOR



LEE D. DONOHUE
ACTING CHIEF
WILLIAM B. CLARK
DEPUTY CHIEF

JEREMY HARRIS
MAYOR

DEPARTMENT OF WASTEWATER MANAGEMENT
CITY AND COUNTY OF HONOLULU
830 SOUTH KING STREET
HONOLULU HAWAII 96813



KENNETH E. SPRAGUE, P.E., P.C.
DIRECTOR
CHESTER K. OLUMBA, BEPE, BEC
DEPUTY DIRECTOR

OUR REFERENCE BS-DL

February 12, 1998

April 8, 1998

WPP 98-195

Mr. Roy K. Abe
Vice President
Hawaii Pacific Engineers, Inc.
1132 Bishop Street, Suite 1003
Honolulu, Hawaii 96813-2830

Dear Mr. Abe:

This is in response to your letter of February 3, 1998, regarding the Supplemental Environmental Impact Statement Preparation Notice for the Waimanalo Wastewater Facilities Plan in Koolaupoko.

This project should have no significant impact on the operations of the Honolulu Police Department.

Thank you for the opportunity to review this document.

Sincerely,

LEE D. DONOHUE
Acting Chief of Police

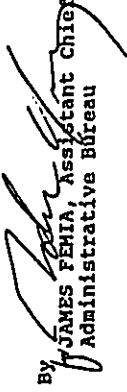
By 
JAMES FEMIA, Assistant Chief
Administrative Bureau

TO: LEE DONOHUE, ACTING POLICE CHIEF
JAMES FEMIA, ASSISTANT CHIEF, ADMINISTRATIVE BUREAU
HONOLULU POLICE DEPARTMENT

FROM: KENNETH E. SPRAGUE, CHIEF
DEPARTMENT OF WASTEWATER MANAGEMENT
CHESTER K. OLUMBA, BEPE, BEC

SUBJECT: SUPPLEMENTAL ENVIRONMENTAL IMPACT STATEMENT PREPARATION
NOTICE FOR WAIMANALO WASTEWATER FACILITIES PLAN
Koolaupoko, Oahu, Hawaii

Thank you for your letter of February 12, 1998, to Hawaii Pacific Engineers, Inc. regarding the subject project.

Should you desire any additional information on the project, please feel free to contact me or either one of our project engineers, Mr. Carl Arakaki at 523-4671, or Mr. Robert Hiyasaki at 527-5159.

cc: Hawaii Pacific Engineers, Inc.

RECEIVED
MAR 24 1998
HAWAII PACIFIC
ENGINEERS INC.

HAWAII PACIFIC
ENGINEERS INC.

STATE OF HAWAII
DEPARTMENT OF HAWAIIAN HOME LANDS
P.O. BOX 1574
HONOLULU, HAWAII 96819



REGISTRATION
EXPIRES
2000

JEREMY HARRIS
MAYOR

DEPARTMENT OF WASTEWATER MANAGEMENT
CITY AND COUNTY OF HONOLULU
630 SOUTH KING STREET
HONOLULU, HAWAII 96813



KENNETH E. SPRAGUE, P.E.,
DIRECTOR
GENERAL & DESIGN DEPT.
SEWER DIVISION

March 19, 1998

Mr. Roy K. Abe, Vice President
Hawaii Pacific Engineers, Inc.
1132 Bishop Street, Suite 1603
Honolulu, Hawaii 96813-2830

Dear Mr. Abe:

Subject: Supplemental Environmental Impact Statement Preparation
Notice for Waimanalo Wastewater Facilities Plan,
Koolaulopoko, Oahu, Hawaii

Thank you for the opportunity to review the subject report. We have
no comments at this time.

Please include the Department of Hawaiian Home Lands as a consulted
party during the remainder of the EIS review process. If you have
any questions, call Joe Chu at 587-6421.

Aloha,

Kali Watson

KALI WATSON, Chairman
Hawaiian Homes Commission

April 20, 1998

Mr. Kali K. Watson, Director
Department of Hawaiian Homelands
P.O. Box 1879
Honolulu, Hawaii 96805

Dear Mr. Watson:

Subject: Supplemental Environmental Impact Statement Preparation
Notice for Waimanalo Wastewater Facilities Plan
Koolaulopoko, Oahu, Hawaii

Thank you for your letter of March 19, 1998 to Hawaii Pacific Engineers, Inc.
regarding the subject project.

We will be providing you with a copy of the Draft Supplemental Environmental
Impact Statement (DSEIS) upon its completion. We look forward to your agency's
continued participation as a consulted party. If there are any questions, please feel
free to contact me or either one of our project engineers, Mr. Carl Arakaki at
523-4671, or Mr. Robert Miyasaki at 527-5159. Thank you very much for your
interest in this project.

Sincerely,

CHERYL K. OKUMA-SEPE

KENNETH E. SPRAGUE
Director

cc: Hawaii Pacific Engineers, Inc.

WPP 98-224



STATE OF HAWAII
DEPARTMENT OF LAND AND NATURAL RESOURCES

LAND DIVISION
PO BOX 521
HONOLULU, HAWAII 96809

March 23, 1998

LD-NAV

Mr. Roy K. Abe, Vice President
Hawaii Pacific Engineers, Inc.
1332 Bishop Street Suite 1003
Honolulu, Hawaii 96813 2830

Dear Mr. Abe:

SUBJECT: Review Supplemental Environmental Impact Statement
Preparation Notice (SEISPN)
Project : Waimanalo Wastewater Facilities Plan
Applicant: Department of Wastewater Management
City and County of Honolulu
Location : Koolaupoko, Island of, Oahu, Hawaii
TMK : 1st/4-1-Various

Thank you for the opportunity to review and comment on the subject Supplemental Environmental Impact Statement Preparation Notice for the proposed Waimanalo Wastewater Facility.

Attached is our Division of Aquatic Resources and Commission on Water Resource Management's comments related to Natural and Water Resources value respectively.

Figure II-26 of the SEISPN incorrectly makes reference to "Waimanalo Bay State Recreation Area." That park is under the City and County's jurisdiction due to a transfer in 1992.

The Department of Land and Natural Resources has no other comments to offer on the subject matter at this time. Should you have any questions, please contact Nick Vaccaro of our Land Division's Support Services Branch at 587-0438.

Very truly yours,

Dean Y. Uchida
DEAN Y. UCHIDA
Administrator

c: At Large Land Board Member
Oahu Land Board Member
Oahu District Land Office

STATE OF HAWAII
Department of Land and Natural Resources
Division of Aquatic Resources

SUSPENSE DATE: Tuesday, March 17, 1998

MEMORANDUM

To: William Devick, Acting Administrator
From: Richard Sixberry, Aquatic Biologist

Subject: Comments on Supplemental Environmental Impact Statement Preparation Notice (SEISPN)

Comments Requested By: Dean Uchida, Land Division

Date of Request: 3/6/98 Date Received: 3/11/98

SUMMARY of Project

Title: Waimanalo Wastewater Facilities Plan

Proj. By: C&C - Wastewater Management

Location: Koolaupoko, Oahu

Brief Description:

The applicant is in the process of updating its Waimanalo Wastewater Facilities Plan. The SEISPN describes the basis and recommendations for collection system and treatment facility improvements to meet the wastewater management needs of the Waimanalo community to the year 2020.

Comments:

Although the (SEISPN) describes briefly the proposed project and the potential effects on the environment, we suggest the forthcoming EIS discuss in detail potential short term impacts and propose specific means for averting or minimizing adverse effects, and provide possible mitigation for unavoidable damage to natural resource values.

RECEIVED

DEPARTMENT OF WASTEWATER MANAGEMENT
CITY AND COUNTY OF HONOLULU
 850 SOUTH KING STREET
 HONOLULU, HAWAII 96813



HEMETHE SPANGLER, P.E.
 DIRECTOR
 DEPARTMENT OF WASTEWATER MANAGEMENT
 HONOLULU, HAWAII 96813

WPP 98-223

JEREMY HARRIS
 SENIOR

April 20, 1998

State of Hawaii
DEPARTMENT OF LAND AND NATURAL RESOURCES
 Commission on Water Resource Management
 Honolulu, Hawaii
 March 16, 1998

TO: Mr. Dean Uchida, Administrator
 Land Division

FROM: Edwin T. Sakoda, Acting Deputy Director
 Commission on Water Resource Management (CWRM)

SUBJECT: SEISPN Waimanalo Wastewater Facilities Plan

FILE NO.: SEISPN-WF.COM

Thank you for the opportunity to review the subject document. Our comments related to water resources are marked below.

In general, the CWRM strongly promotes the efficient use of our water resources through conservation measures and use of alternative non-potable water resources whenever available, feasible, and there are no harmful effects to the ecosystem. Also, the CWRM encourages the protection of water recharge areas which are important for the maintenance of streams and the replenishment of aquifers.

- We recommend coordination with the county government to incorporate this project into the county's Water Use and Development Plan.
- We recommend coordination with the Land Division of the State Department of Land and Natural Resources to incorporate this project into the State Water Projects Plan.
- We are concerned about the potential for ground or surface water degradation/contamination and recommend that approval for this project be conditioned upon a review by the State Department of Health and the developer's acceptance of any resulting requirements related to water quality.
- A Well Construction Permit and/or a Pump Installation Permit from the Commission would be required before ground water is developed as a source of supply for the project.
- The proposed water supply source for the project is located in a designated water management area, and a Water Use Permit from the Commission would be required prior to use of this source.
- Groundwater withdrawals from this project may affect streamflows which may require an instream flow standard amendment.
- We recommend that no development take place affecting highly erodible slopes which drain into streams within or adjacent to the project.
- If the proposed project includes construction of a stream diversion, the project may require a stream diversion works permit and amend the instream flow standard for the affected stream(s).
- If the proposed project alters the bed and banks of a stream channel, the project may require a stream channel alteration permit.

[X] OTHER:

We concur with the EIS in that reclaimed water is a viable alternative for the agricultural needs of Waimanalo. The proposed use of reclaimed water for irrigation purposes should, however, be implemented in compliance with the Department of Health's Guidelines for the Treatment and Use of Reclaimed Water. The EIS further notes that certain State agencies such as DLNR, may be responsible for funding a "substantial portion of the wastewater facility capital improvement cost." CWRM, however, is unaware of any proposed cost-sharing plans at this time.

If there are any questions, please contact Dean Nakano at 597-0240.

Mr. Dean Uchida, Administrator
 State of Hawaii
 Department of Land and Natural Resources
 Land Division
 P.O. Box 521
 Honolulu, Hawaii 96809

Dear Mr. Uchida:

**Subject: Supplemental Environmental Impact Statement Preparation
 Notice for Waimanalo Wastewater Facilities Plan
 Koolauopoko, Oahu, Hawaii**

Thank you for your letter of March 23, 1998 to Hawaii Pacific Engineers, Inc. regarding the subject project. We would like to take this opportunity to respond to your specific comments.

The Draft Supplemental Environmental Impact Statement (DSEIS) will refer to the former Waimanalo Bay State Recreation Area by its new name, "Waimanalo Bay Beach Park," and also note that it is now owned and operated by the City and County of Honolulu.

The DSEIS will discuss short term impacts and mitigating measures in further detail. Due to document being a supplemental EIS, the primary focus will be on the impacts associated with proposed action that differ from those of the originally proposed action. The major differences in the proposed action are the substantially increased capacity of the Waimanalo Wastewater Treatment Plant and changes to the planned expansion of the sewer system. The DEIS will emphasize the assessment of long term water quality impacts related to the modified actions. Although similar to those discussed in the original 1984 EIS, anticipated short term impacts will be addressed to minimize the need to refer to the earlier document and to reflect current regulatory and environmental protection requirements.

Mr. Dean Uchida
Page 2
April 20, 1998

As suggested, the DEIS will recommend coordination among the County government agencies to incorporate the proposed reclaimed water projects into the Oahu Water Management Plan.

The implementation of reclaimed water for irrigation purposes will be in full compliance with the applicable regulations and guidelines of the Department of Health (DOH). Facilities required to meet the requirements of the DOH's "Guidelines for the Treatment and Use of Reclaimed Water" are discussed in Waimanalo Facilities Plan and a review of the DOH requirements is appended to the report.

The Department of Wastewater Management is currently discussing funding issues for the Waimanalo Wastewater Treatment Plant with the Land Division of DLNR. The State is expected to fund a large portion of the capital costs because the plant is currently owned by the State.

We will be providing you with a copy of the DSEIS upon its completion. We look forward to your agency's continued participation as a consulted party. If there are any questions, please feel free to contact me or either one of our project engineers, Mr. Carl Arakaki at 523-4671, or Mr. Robert Miyasaki at 527-5159. Thank you very much for your interest in this project.

Sincerely,

CHERYL K. OKUMA-SEFE

KENNETH E. SPRAGUE
Director

cc: Hawaii Pacific Engineers, Inc. ✓

BENJAMIN J. CAVETANO
GOVERNOR OF HAWAII



STATE OF HAWAII
DEPARTMENT OF LAND AND NATURAL RESOURCES

CHIEF OF STATE PARKS
P O BOX 621
HONOLULU, HAWAII 96809

RECEIVED
FEB 20 1998

February 18, 1998
HAWAII PACIFIC
ENGINEERS INC.

COMMISSIONER
MICHAEL D. WILSON
BOARD OF LAND AND NATURAL RESOURCES

DEPUTY DIRECTOR
GILBERT S. COLOMBO

ASSOCIATE DIRECTOR
ADAM W. HARRIS
MANAGING DIRECTOR
JEREMY HARRIS
DIRECTOR
DEPARTMENT OF LAND AND NATURAL RESOURCES
DIVISION OF STATE PARKS
1132 BISHOP STREET, SUITE 1003
HONOLULU, HAWAII 96813-2530

DEPARTMENT OF WASTEWATER MANAGEMENT
CITY AND COUNTY OF HONOLULU
830 SOUTH KING STREET 3RD FLOOR • HONOLULU HAWAII 96813
PHONE: 808/537-5553 • FAX: 808/537-6973



JEREMY HARRIS
DIRECTOR

CHERYL K. CRUZ-SEPE
DIRECTOR
DEPUTY DIRECTOR

WPP 98-201

April 9, 1998

Mr. Roy K. Abe, Vice President
Hawaii Pacific Engineers, Inc.
1132 Bishop Street, Suite 1003
Honolulu, Hawaii 96813-2530

Dear Mr. Abe:

Thank you for the opportunity to review the Supplemental Environmental Impact Statement Preparation Notice for Waimanalo Wastewater Facilities Plan.

There are no existing State Parks in the Waimanalo area. The Waimanalo Bay State Recreation Area shown in Figure II-2a,2b was transferred to the city and county of Honolulu by Act 312, SLH 1991.

As indicated in the preparation notice, Waimanalo Beach is the longest and one of the best beaches in Hawaii. The December, 1996 revision of the State Comprehensive Outdoor Recreation Plan (SCORP) continues to indicate that ocean and shoreline recreation opportunities are major needs for both residents and visitors. While we need to acquire more areas for beach parks, it is at least as important to protect the beach parks we already have by providing acceptable wastewater treatment.

Sincerely,

RAILSTON H. NAGATA
State Parks Administrator

Mr. Ralston H. Nagata, State Parks Administrator
Department of Land and Natural Resources
Division of State Parks
P.O. Box 621
Honolulu, Hawaii 96809

Dear Mr. Nagata:

Subject: Supplemental Environmental Impact Statement Preparation Notice for Waimanalo Wastewater Facilities Plan
Koolauloko, Oahu, Hawaii

Thank you for your letter of February 18, 1998, to Hawaii Pacific Engineers, Inc. regarding the subject project.

The Draft Supplemental Environmental Impact Statement (DSEIS) will refer to the former Waimanalo Bay State Recreation Area by its new name, "Waimanalo Bay Beach Park," and also note that it is now owned and operated by the City and County of Honolulu. We fully agree with your statement that it is important to protect existing beach parks by providing acceptable wastewater treatment.

We will provide the Department of Land and Natural Resources with copies of the DSEIS upon it is completion. We look forward to your agency's continued participation as a consulted party. If there are any questions, please feel free to contact me or either one of our project engineers, Mr. Carl Arakaki at 523-4671, or Mr. Robert Miyasaki at 527-5159. Thank you very much for your interest in this project.

Sincerely,

CHERYL K. CRUZ-SEPE
KENNETH E. SPRAGUE
Director

cc: Hawaii Pacific Engineers, Inc.

RECEIVED
MAR 11 1998

BELOWAS CASTILLO
DIRECTOR



HAWAII PACIFIC
ENGINEERS INC.

STATE OF HAWAII
DEPARTMENT OF BUDGET AND FINANCE
HOUSING FINANCE AND DEVELOPMENT CORPORATION
177 QUEEN STREET, SUITE 300
HONOLULU, HAWAII 96813
FAX (808) 587-0860

ROY S. OSHIRO
EXECUTIVE DIRECTOR

REPLY-NOTES TO

98: PPE/836

March 6, 1998

Mr. Roy K. Abe
Vice President
Hawaii Pacific Engineers, Inc.
1122 Bishop Street, Suite 1003
Honolulu, Hawaii 96813-2830

Dear Mr. Abe:

Re: Supplemental Environmental Impact Statement Preparation
Notice (EISPN) for Waimanalo Wastewater Facilities Plan,
Koolaupoko, Oahu, Hawaii

Thank you for the opportunity to review the subject EISPN.
We have no housing-related comments to offer at this time.
However, we would appreciate being consulted during the
remainder of the EIS review process.

Sincerely,

ROY S. OSHIRO
Executive Director

DEPARTMENT OF WASTEWATER MANAGEMENT
CITY AND COUNTY OF HONOLULU
810 SOUTH KING STREET, 3RD FLOOR • HONOLULU, HAWAII 96813
PHONE: (808) 527-5652 • FAX: (808) 527-6675



RECEIVED
APR 15 1998

HAWAII PACIFIC
ENGINEERS INC.

JEREMY HARRIS
MAYOR

KENNETH E. SPRAGUE P.E., P.D.
DIRECTOR
CHERYL K. OSHIRO-SPEISE
SENIOR DIRECTOR

WPP 98-198

April 9, 1998

Mr. Roy Oshiro, Executive Director
State of Hawaii
Department of Budget and Finance
Housing Finance and Development Corporation
677 Queen Street, Suite 300
Honolulu, Hawaii 96813

Dear Mr. Oshiro:

Subject: Supplemental Environmental Impact Statement Preparation
Notice for Waimanalo Wastewater Facilities Plan
Koolaupoko, Oahu, Hawaii

Thank you for your letter of March 6, 1998, to Hawaii Pacific Engineers, Inc. regarding the
subject project.

We will provide you with a copy of the Draft Supplemental Environmental Impact
Statement (DSEIS) upon its completion. We look forward to your agency's continued
participation as a consulted party. If there are any questions, please feel free to contact
me or either one of our project engineers, Mr. Carl Arakaki at 523-4671, or Mr. Robert
Miyasaki at 527-5159. Thank you very much for your interest in this project.

Sincerely,

CHERYL K. OSHIRO-SPEISE

KENNETH E. SPRAGUE
Director

cc: Hawaii Pacific Engineers, Inc.



BENJAMIN J. CAVETANO
GOVERNOR



STATE OF HAWAII
OFFICE OF ENVIRONMENTAL QUALITY CONTROL

378 SOUTH BERTANAMA STREET
SUITE 102
HONOLULU, HAWAII 96813
TELEPHONE (808) 586-4185
FACSIMILE (808) 586-4185

RECEIVED

FEB 27 1998

GARY GILL
DIRECTOR

HAWAII PACIFIC
ENGINEERS INC.

Kenneth Sprague
February 26, 1998
Page 2

February 26, 1998

Mr. Kenneth Sprague
Department of Wastewater Management
650 South King Street
Honolulu, Hawaii 96813

Attention: Carl Arakaki

Dear Mr. Sprague

Subject: Environmental Impact Statement (EIS) Preparation Notice for Wai-manalo
Wastewater Facilities Plan

We have the following comments to offer:

1. **Zoning:** The EIS preparation notice does not list TMKs. For all parcels involved, please indicate zoning and fee ownership.
2. **Contacts:** In the draft EIS document all contacts during the EIS preparation notice pre-consultation phase and include copies of any correspondence.
3. **Endangered flora species:** Section III-B, *Biological Environmental Characteristics*, indicated six possible species of endangered plants, yet the discussion in section IV-B-2, *Short Term Impacts and Mitigation Measures*, states that no endangered species of flora or fauna exist on the project site. Please clarify this in the draft EIS.
4. **Safety:** In the draft EIS, indicate what measures will be taken during the construction phase of the project to ensure safety of pedestrians as well as protecting construction equipment and supplies from vandalism and theft.

5. Water Issues:

- ▶ Three new injection wells are proposed. Will the existing injection wells continue to be used? In the draft EIS please fully discuss the alternative of reusing treated effluent for irrigation purposes.
 - ▶ After the implementation of this project, what change in the water quality of Wai-manalo Bay can be expected?
6. **Odor:** Discuss the proximity of the wastewater treatment plant to the Unisyn facility and the cumulative impacts on residents from any odors known to exist in the area.

If you have any questions please call Nancy Heinrich at 586-4185.

Sincerely,

Gary Gill
Director

c: Roy Abe, Hawaii Pacific Engineers

DEPARTMENT OF WASTEWATER MANAGEMENT
CITY AND COUNTY OF HONOLULU
430 SOUTH KING STREET
HONOLULU, HAWAII 96813



JEREMY HARRIS
MAYOR

KENNETH E. SPRAGUE, P.E., PH.D.
DIRECTOR
CHERYL K. OKUMA SEPE, A.S.P.
DEPUTY DIRECTOR

WPP 98-209

April 17, 1998

Mr. Gary Gill, Director
Office of Environmental Quality Control
235 South Beretania Street, Suite 702
Honolulu, Hawaii 96813

Dear Mr. Gill:

Subject: Supplemental Environmental Impact Statement Preparation
Notice for Waimanalo Wastewater Facilities Plan
Koolauopoko, Oahu, Hawaii

Thank you for your letter of February 26, 1998 regarding the subject project. With regard to your specific comments, we offer the following responses:

Zoning: We will include TMK number, zoning and fee ownership information for all major parcels anticipated to be involved in the project.

Contacts: We will include summaries of key contacts made during the pre-consultation phase and any relevant correspondence.

Endangered flora species: We will provide clarification on the discussion of endangered flora to indicate that although six possible species of endangered plants may exist within the planning area, none are known to exist on the specific proposed project sites.

Safety: We will indicate measures that will be taken during the construction phase of the project to ensure pedestrian safety and protect construction equipment and supplies from vandalism and theft.

Water Issues: Three existing injection wells will continue to be used along with the three proposed new wells. The alternative of reusing treated effluent will be discussed in detail.

The periodic occurrence of algal blooms is a water quality concern in Waimanalo Bay. The proposed improvements will reduce the discharge of nutrients and other contaminants to the groundwater and nearshore waters. The extent of water quality improvements that would be realized, however, would be difficult to predict due to the

Mr. Gary Gill
Page 2
April 17, 1998

complex nature of groundwater movement and ocean currents in the area, and the unknown relative impacts of non-point and other sources of pollution. The difficulties encountered in identifying the cause of the algal bloom problems on Maui despite extensive research and field investigations is an example of the complex nature of water quality impact assessments in coastal waters. Due to the lack of funds and the limited scope of our project, we are recommending that additional studies be conducted in the future by others to assess the various pollution sources in the Waimanalo watershed and their relative impacts to water quality. We recommend that the additional studies be funded by the Kailua Bay Advisory Council utilizing funds that were derived from the Kailua Wastewater Treatment Plant lawsuit.

Odor: The potential for odor generation from the treatment plant will be included. The relative effect of the treatment odor on the background of the Unisyn operation, agricultural and livestock activities will be addressed on a qualitative basis. It should be noted that the Waimanalo Wastewater Treatment Plant operators have not received any complaints of odors originating at the plant in the past ten years.

If there are any questions, please feel free to contact me or either one of our project engineers, Mr. Carl Arakaki at 523-4671, or Mr. Robert Miyasaki at 527-5159. Thank you very much for your interest in this project.

Sincerely,

KENNETH E. SPRAGUE
Director

BENJAMIN J. CAVETIANO
GOVERNOR
SELUF. MAYA
DIRECTOR
BRADLEY J. MOSEKOWSKI
DEPUTY DIRECTOR
RICK EGGED
DIRECTOR OFFICE OF PLANNING

DEPARTMENT OF BUSINESS,
ECONOMIC DEVELOPMENT & TOURISM

OFFICE OF PLANNING
235 South Beretania Street, 6th Fl., Honolulu, Hawaii 96813
Mailing Address: P.O. Box 2359, Honolulu, Hawaii 96801

Ref. No. P-7210

RECEIVED
FEB 27 1998
HAWAII PACIFIC
ENGINEERS INC.

February 17, 1998

Mr. Roy K. Abe
Vice President
Hawaii Pacific Engineers, Inc.
1132 Bishop Street, Suite 1003
Honolulu, Hawaii 96813-2830

Dear Mr. Abe:

Subject: Supplemental Environmental Impact Statement Preparation Notice for
Waimanalo Wastewater Facilities Plan, Koolauopoko, Hawaii

We have reviewed the Waimanalo Wastewater Facilities Plan Supplemental Environmental Impact Statement Preparation Notice (SEISPN). The project will eliminate the use of approximately 350 individual wastewater systems in the coastal area of Waimanalo Bay. The project also allows for the production and use of reclaimed water. These benefits of the project are consistent with the objectives and policies of our Coastal Nonpoint Pollution Control Program Management Plan.

On page 26, fourth paragraph, the SESIPN states that "Available research information indicates that the subsurface leachates from individual wastewater systems in Waimanalo are not a major source of microbiological contaminants (pathogens) in recreational coastal water." Please reference these studies in this paragraph. Do these data come from the reports by A.I. El-Kadi and R. Fujioka (1997), J. Thompson (1993), and A. Wu (1994), listed in the reference section?

If you have questions, please contact Steve Olive of our Coastal Zone Management Program at 587-2877.

Sincerely,

Rick Egged
Rick Egged
Director
Office of Planning

DEPARTMENT OF WASTEWATER MANAGEMENT
CITY AND COUNTY OF HONOLULU

510 SOUTH KING STREET, 2ND FLOOR • HONOLULU, HAWAII 96813
PHONE: (808) 537-8893 • FAX: (808) 537-8873



JEREMY HARRIS
DIRECTOR

HEMETHE SPRAGUE P.L.P.C.
DIRECTOR
CHERYL K. OKUMA-SEPE
DEPUTY DIRECTOR

April 9, 1998

WPP 98-200

Mr. Rick Egged, Director
Office of Planning
Department of Business, Economic Development and Tourism
P.O. Box 2359
Honolulu, Hawaii 96804

Dear Mr. Egged:

Subject: Supplemental Environmental Impact Statement Preparation
Notice for Waimanalo Wastewater Facilities Plan
Koolauopoko, Oahu, Hawaii

Thank you for your letter of February 17, 1998, to Hawaii Pacific Engineers, Inc. regarding the subject project.

The Draft Supplemental Environmental Impact Statement (DSEIS) will discuss the impacts of contaminants from individual wastewater systems on water quality in Waimanalo in greater detail. The study by El-Kadi and Fujioka (1997) will be appended to the DSEIS and findings of other studies will be fully referenced.

We will provide you with a copy of the DSEIS upon its completion. We look forward to your agency's continued participation as a consulted party. If there are any questions, please feel free to contact me or either one of our project engineers, Mr. Carl Arakaki at 523-4671, or Mr. Robert Miyasaki at 527-5159. Thank you very much for your interest in this project.

Sincerely,

CHERYL K. OKUMA-SEPE
KENNETH E. SPRAGUE
Director

cc: Hawaii Pacific Engineers, Inc.

DEPARTMENT OF WASTEWATER MANAGEMENT
CITY AND COUNTY OF HONOLULU
810 SOUTH KING STREET, 3RD FLOOR, HONOLULU, HAWAII 96813
PHONE: (808) 527-4633 • FAX: (808) 527-4873



KENNETH E. SPRAGUE, P.E., Ph.D.
DIRECTOR
CERYL K. OJUMA, DEFE, LLC
DEPUTY DIRECTOR

WPP 98-199

April 9, 1998

RECEIVED
MAR 14 1998



STATE OF HAWAII
OFFICE OF HAWAIIAN AFFAIRS
711 KAPIOLANI BOULEVARD, SUITE 500
HONOLULU, HAWAII 96813-5249
PHONE (808) 594-1888
FAX (808) 594-1855
March 10, 1998

HAWAII PACIFIC
ENGINEERS, INC.

Mr. Roy K. Abe
Hawaii Pacific Engineers, Inc.
1132 Bishop Street, Suite 1003
Honolulu, HI 96813-2830

Doc. No. EIS-152

Subject: Supplemental environmental impact statement preparation notice
(SEISPN) for Waimanalo Wastewater Facilities Plan, Koolauapoko,
Island of Oahu

Dear Mr. Abe:

Thank you for the opportunity to review the SEISPN for Waimanalo
Wastewater Facilities Plan, Koolauapoko, Island of Oahu. The Waimanalo
Wastewater Facilities Plan is a comprehensive framework describing
recommended improvements for the Waimanalo Wastewater facility.

The Office of Hawaiian Affairs (OHA) has no comments at this time to
the SEISPN. But OHA intends to thoroughly review the SEIS once it is available
for public review. Major issues for OHA and the local Hawaiian community will
be potential impacts of proposed changes and improvements in wastewater
collection and treatment on the environment, public health, and water quality.

Please contact Colin Kippen (594-1938), LNR Officer, or Luis Manrique
(594-1758), should you have any questions on this matter.

Sincerely yours,

Randall Ogata
Administrator

Colin Kippen
Officer, LNR Division

cc: Board of Trustees

Mr. Randall Ogata, Administrator
Mr. Colin Kippen, Officer, LNR Division
Office of Hawaiian Affairs
711 Kapiolani Boulevard, Suite 500
Honolulu, Hawaii 96813-5249

Dear Mr. Ogata and Mr. Kippen:

Subject: Supplemental Environmental Impact Statement Preparation
Notice for Waimanalo Wastewater Facilities Plan
Koolauapoko, Oahu, Hawaii

Thank you for your letter of March 10, 1998, to Hawaii Pacific Engineers, Inc. regarding
the subject project.

We will provide you with a copy of the Draft Supplemental Environmental Impact
Statement (DSEIS) upon its completion. We look forward to your agency's continued
participation as a consulted party. If there are any questions, please feel free to contact
me or either one of our project engineers, Mr. Carl Arakaki at 523-4671, or Mr. Robert
Miyasaki at 527-5159. Thank you very much for your interest in this project.

Sincerely,

CERYL K. OJUMA, DEFE

KENNETH E. SPRAGUE
Director

cc: Hawaii Pacific Engineers, Inc.



United States
Department of
Agriculture
Natural
Resources
Conservation
Service
P.O. Box 50004
Honolulu, HI
96850

Our People...Our Islands...In Harmony

March 10, 1998

RECEIVED

MAR 13 1998

HAWAII PACIFIC
ENGINEERS INC.

Mr. Roy K. Abe, Vice President
Hawaii Pacific Engineers, Inc.
1132 Bishop Street, Suite 1003
Honolulu, Hawaii 96813-2830

Dear Mr. Abe:

Subject: Supplemental Environmental Impact Statement Preparation Notice for
Waimanalo Wastewater Facilities Plan, Koolauapoko, Oahu, Hawaii

We have reviewed the above mentioned document and have no comments to offer at
this time.

Thank you for the opportunity to review this document.

Sincerely,

KENNETH M. KANESHIRO
State Conservationist

DEPARTMENT OF WASTEWATER MANAGEMENT
CITY AND COUNTY OF HONOLULU

830 SOUTH KING STREET, 3RD FLOOR • HONOLULU, HAWAII 96813
PHONE: (808) 537-6653 • FAX: (808) 537-6975



SEWER/WASTEWATER
DIVISION

KENNETH E. SPRAGUE, P.E., Ph.D.
DIRECTOR
CHERYL K. OJUMA SEFE, EIT
SENIOR MANAGER

WPP 98B-203

April 9, 1998

Mr. Kenneth M. Kaneshiro, State Conservationist
U.S. Department of Agriculture
Natural Resources Conservation Service
P.O. Box 50004
Honolulu, Hawaii 96850

Dear Mr. Kaneshiro:

Subject: Supplemental Environmental Impact Statement Preparation
Notice for Waimanalo Wastewater Facilities Plan
Koolauapoko, Oahu, Hawaii

Thank you for your letter of March 10, 1998, to Hawaii Pacific Engineers, Inc. regarding
the subject project.

We will provide you with a copy of the Draft Supplemental Environmental Impact
Statement (DSEIS) upon it is completion. We look forward to your agency's continued
participation as a consulted party. If there are any questions, please feel free to contact
me or either one of our project engineers, Mr. Carl Arakaki at 523-4671, or Mr. Robert
Miyasaki at 527-5159. Thank you very much for your interest in this project.

Sincerely,

CHERYL K. OJUMA-SEFE
KENNETH E. SPRAGUE
Director

cc: Hawaii Pacific Engineers, Inc.



DEPARTMENT OF THE ARMY
U.S. ARMY ENGINEER DISTRICT, HONOLULU
FORT SHAFTER, HAWAII 96858-5440

REPLY TO
ATTENTION OF

February 26, 1998

Civil Works Branch

RECEIVED

FEB 27 1998

HAWAII PACIFIC
ENGINEERS INC.



DEPARTMENT OF WASTEWATER MANAGEMENT
CITY AND COUNTY OF HONOLULU
430 SOUTH KING STREET, 3RD FLOOR • HONOLULU, HAWAII 96813
PHONE: (808) 527-6833 • FAX: (808) 527-6838

JEREMETH E. SPRAGUE
DIRECTOR

JEREMETH E. SPRAGUE, P.E., Ph.D.
DIRECTOR
CHERYL K. OGDUM-DEFE, E.I.C.
DEPUTY DIRECTOR

WPP 98-202

April 9, 1998

Mr. Paul Mizue, Chief
Civil Works Branch
U.S. Army Engineer District, Honolulu
Fort Shafter, Hawaii 96858-5440

Dear Mr. Mizue:

Subject: Supplemental Environmental Impact Statement Preparation
Notice for Waimanalo Wastewater Facilities Plan
Koolauapoko, Oahu, Hawaii

Thank you for your letter of February 26, 1998, to Hawaii Pacific Engineers, Inc. regarding the subject project.

We appreciate your comments pointing out that Department of Army permits will not be required for the project and that our flood hazard information is correct as shown.

We will provide you with a copy of the Draft Supplemental Environmental Impact Statement (DSEIS) upon it is completion. We look forward to your agency's continued participation as a consulted party. If there are any questions, please feel free to contact me or either one of our project engineers, Mr. Carl Arakaki at 523-4671, or Mr. Robert Miyasaki at 527-5159. Thank you very much for your interest in this project.

Sincerely,

CHERYL K. OGDUM-DEFE

JEREMETH E. SPRAGUE
Director

cc: Hawaii Pacific Engineers, Inc.

Mr. Roy K. Abe
Vice President
Hawaii Pacific Engineers
1132 Bishop Street, Suite 1003
Honolulu, Hawaii 96813

Dear Mr. Abe:

Thank you for the opportunity to review and comment on the Supplemental Environmental Impact Statement Preparation Notice (SEISPN) for the Waimanalo Wastewater Facilities Plan, Koolauapoko, Oahu (TAK 4-1). The following comments are provided in accordance with Corps of Engineers authorities to provide flood hazard information and to issue Department of the Army (DA) permits.

a. Based on the information provided, a DA permit will not be required for the project. For further information, please contact Mr. William Lennan of our Regulatory Section at 438-9258 (extension 13) and refer to file number 98000019.

b. The flood hazard information provided on page 19 of the SEISPN is correct.

Sincerely,

Paul Mizue

Paul Mizue, P.E.
Chief, Civil Works Branch

DEPARTMENT OF WASTEWATER MANAGEMENT
CITY AND COUNTY OF HONOLULU
830 SOUTH KING STREET
HONOLULU, HAWAII 96813



JEREMY HARRIS
MAYOR

HELMUTH E. SMOLUCZ, P.E., Ph.D.
DIRECTOR
CHRISTLE OLUMWA STPE
DEPUTY DIRECTOR

WPP 98-235

May 21, 1998

RECEIVED
MAR 13 1998
HAWAII PACIFIC
ENGINEERS INC.

Kailua Neighborhood Board
PLANNING AND ZONING COMMITTEE
519 Wanaao Road
Kailua, Hawaii 96734

Department of Wastewater Management
650 S. King Street
Honolulu, Hawaii 96813

March 10, 1998

Dear Sirs:

At its meeting of March 5, 1998, the Kailua Neighborhood Board voted 16-1 to request to be a consulted party in the Draft EIS for the Waimanalo Wastewater Facilities Plan.

The Board is participating in the revision of the City and County of Honolulu Development Plan which will determine the future population distribution in the Koolau area to the year 2020. We have serious concerns about the statement in the preparation notice by the Department of Wastewater Management which appears to indicate that they have already determined the Waimanalo area's 2020 population, and have used it as a basis to determine the size of the treatment plant.

Sincerely,

Charles A. Prentiss, Ph.D.
Planning and Zoning Chair

Dr. Charles A. Prentiss, Planning and Zoning Chair
Kailua Neighborhood Board
Planning and Zoning Committee
519 Wanaao Road
Kailua, Hawaii 96734

Dear Dr. Prentiss:

Subject: Supplemental Environmental Impact Statement Preparation
Notice for Waimanalo Wastewater Facilities Plan
Koolau area, Oahu, Hawaii

Thank you for your letter of March 10, 1998, regarding the subject project. We appreciate your concerns regarding potential conflicts between the growth projections in the Waimanalo Wastewater Facilities Plan and those that will be forthcoming as a result of revisions to the Koolau area Development Plan. Please be assured that we intend to modify our proposed facility recommendations as necessary in the future to accommodate any major development plan revisions. Presented below are some background information on our project and our response to your comments that will hopefully mitigate your concerns.

The Waimanalo Wastewater Treatment Plant (WWTP) is owned by the State of Hawaii. The City and County of Honolulu, Department of Wastewater Management (WWM) currently has an agreement with the State to operate and maintain the plant. WWM began the Waimanalo Wastewater Facilities Plan project in early 1996 as a result of a pressing need to increase the capacity of the Waimanalo WWTP. Due to continued growth in Waimanalo and the use of outdated treatment technology, the plant has been experiencing unstable performance and periodic effluent violations. Intermittent episodes of poor effluent quality has resulted in the clogging of existing effluent disposal wells which results in increased risks of overflow of effluent during peak flow periods. There is a moratorium on new connections to the sewer system in Waimanalo until the capacity of the plant is increased.

An important component of the wastewater facility planning process is the development of growth projections. Due to capacity problems described above, we hope to complete the planning work for the treatment plant expansion by mid-1998. It does not appear to be prudent or necessary to substantially delay our project completion to fully reflect the Koolau area Development Plan revisions. In developing our projections, we worked with the City Planning Department and utilized its Traffic Analysis Zone (TAZ) population projections along with other available land use information. Much of the future increase in population in Waimanalo is anticipated to be due to additional development by the

Dr. Charles A. Prentiss
Page 2
May 21, 1998

Department of Hawaiian Home Lands (DHHL), which is not subject to land use and zoning regulations. We attempted to work closely with DHHL in accommodating their future planned developments, including possible development of the surplus Bellows Air Force Station land.

Although our study recommends an increase in plant capacity from 0.7 to 1.1 million gallons per day (mgd), this action is not intended to dictate the future population of Waimanalo nor the nature and location of future development. The proposed plant expansion is based on somewhat conservative assumptions since under sizing of major infrastructure can result in operational problems and development constraints, as demonstrated by past history in Waimanalo. It should be noted that approximately 30 percent of the projected increase in capacity can be attributed to possible extension of sewers to service existing homes currently served by cesspools and septic tank systems. It is also important to note that it is not cost-effective to increase the plant capacity in small increments at frequent intervals. For this reason, we generally expand facilities in large increments to accommodate flow increases in 20 to 50 year increments, depending on the treatment process components involved.

The capacity of the treatment facility should not determine the rate or extent of population growth as this should be determined by land use policies. Our 2020 projections and recommendations simply serve as a general planning tool for proposed phasing and incremental expansion of future facilities.

The findings and recommendations of the Waimanalo Facilities plan are subject to change based on any major revisions to the Koolauoko Development Plan and the many other factors that affect development. Adjustments can be made to treatment unit capacities during the preliminary engineering and design phases of the project where required and justified based on additional information that may become available. Planning of wastewater facilities is an ongoing dynamic process which requires the consideration of the latest available information and technology.

In the Draft Supplemental Environmental Impact Statement (DSEIS), we will clarify the objectives and scope of the wastewater facility planning process. We will emphasize the need to consider future revisions to the Koolauoko Development Plan during subsequent engineering phases of the project.

We will be providing the Kailua Neighborhood Board with a copy of the DSEIS upon its completion. We look forward to your organization's participation as a consulted party. If there are any questions, please feel free to contact me or either one of our project engineers, Mr. Carl Arakaki at 523-4671, or Mr. Robert Miyasaki at 527-5159. Thank you very much for your interest in this project.

Sincerely,

KENNETH E. SPRAGUE
Director

cc: Planning Dept.



RECEIVED

MAR 17 1998

HAWAII PACIFIC
ENGINEERS INC.

HILLTOP EQUESTRIAN CENTRE

P.O. BOX 502

WAIMANALO, HAWAII 96795

(808) 259-8403

Fax: (808) 259-8870

REC'D

93 MAR -9 P2:59

18-420
J.P.
J.P.

March 7, 1998

Mr. Carl Arabaki
Mr. Robert Miyasaki
Department of Wastewater Management
City and County of Honolulu
650 S. King Street, 3rd Floor
Honolulu, Hawaii 96815

RE: Waimanalo Wastewater Facilities Plan EIS Preparation Notice

Dear Sirs:

Environmental Impact Statements are required to assess the "Big Picture" including the overall, cumulative impact; related actions in the region; and further actions contemplated." Since both Koolauoko and Windward Oahu are regions and I address my comments to the overall and related actions:

- 1) Waimanalo has been subject to a degrading form of air, water and noise pollution for the past several years.
- 2) Other communities, i.e. Aiea, have also suffered similar degradations.
- 3) Public Notice was issued on March 4, 1998 by the Commission on Water Resource Management regarding the addition of the Makaii water wells to the municipal water system to provide an additional 1,500,000 gallons per day of pure water.
- 4) DLNR Chair Michael Wilson recently stated at a UH gathering that Oahu will run out of water in 15 to 20 years.
- 5) The Waimanalo and Aiea wastewater plants dump 70,000,000 gallons a day of wastewater in the ocean.

The Waimanalo Wastewater Facilities Plan of April 1997 references the Unisyn Facility and farm lots designated to receive treated effluent repeatedly yet the plan defers to the State DOH and other studies for information regarding Unisyn and its cumulative environmental effect (chap. 7.6). There are no other current environmental studies and the refusal of State and County Agencies to address the issue by way of Environmental Assessment has placed the burden of assessing the environmental impacts of Unisyn on the community where it does not belong. The Facilities Plan must address these issues to provide a complete insight into the Windward Environment.

Dr. Kenneth Sprague

Page 2

July 30, 1997

A VIABLE ALTERNATIVE EXISTS THAT WILL BENEFIT THE ENVIRONMENT.

The closed Kapaa landfill will produce methane for 100 years. A methane to electricity plant already produces electricity for public consumption there. Leachate from the landfill pollutes the Kawatani Swamp where a migratory bird habitat is planned.

Wastewater reuse and energy production are economically feasible and environmentally beneficial methods of waste disposal for which Federal, State and City funds are available. A multi-use facility constructed to produce R-1 water (for irrigating golf courses, cemeteries, assist in maintaining water levels of the migratory bird habitat to prevent avian botulism, and provide water to farmers through the Maimawili and Waimanalo agricultural irrigation systems) and provide for the processing of solid waste for the recovery of energy (methane from food waste and sewage) at Kapaa and will comply with or exceed Federal mandates and save quality drinking water.

A multi-use wastewater and commercial wet waste plant at the closed Kapaa landfill will remove a major source of air, noise and ground water pollution from Waimanalo and Aiea, better the water quality of Kawatani Swamp and Inosole Stream hence the Class AA recreation water at Hawai'i's longest white sand beaches, Kailua and Waimanalo. The multi-use facility will remove 14 miles from the transportation route of commercial wet waste and may make the widening of Kalaniana'ole Highway in Waimanalo unnecessary.¹

OTHER CONCERNS OF THE EIS

The Facilities Plan suggests a two cell reservoir at the site of the Wing King Reservoir for storage of treated R-1 effluent (pg. 9-94).² The Wing King Reservoir is currently used by Unisyn to store R-3 wastewater reclaimed from its own process of recovery of water from rotting meats, poultry and vegetables. In August of 1995 the reservoir contained 3,000 CFU per 100 ml of Fecal Coliform and 28,000 CFU per 100 ml of total coliforms, 100 times more than the permitted irrigation water rate of 240 CFU per 100 ml under Title 11, Chapter 62 of the Hawaii Administrative Rules (Appendix A4-2). Why must there be any expenditure for treated R-1 effluent when R-3 effluent is permitted by the Department of Health to be (and is already) used on bananas, soy bean and corn?

¹\$800,000 already appropriated for study by State DOT

² The tax map key number cited is incorrect. There is also no room for a 3.5 million gallon two-cell reservoir on the 1.9 acre lot which the 4 million gallon Wing King Reservoir is currently located.

Dr. Kenneth Sprague
Page 3
July 30, 1997

The plan also suggests certain farm lots as designated for wastewater reuse. These same farm lots are the targeted lots for Unisyn's wastewater reuse program. In a letter dated May 5, 1997, Dr. Mike, of the State Department of Health informed DLNR Chairman Michael Wilson "As a condition of the (Unisyn) permit renewal, the effluent from the digesters shall not be discharged into the reservoir but held or stored separately for further treatment or reuse." Does this infer the decision for a new wastewater reservoir that is in the planning stage for construction on the University of Hawai'i Prime AG-1 land by the National Resource Conservation Service (NRCS) is connected to Unisyn process water? The removal of Prime and/or AG-1 land from productive use is contrary to existing land use policies of the State and City which require the protection of that land from urban pressures.

The USDA claims that a fresh water spring exists within the Wing King Reservoir. Since the hydrology of the spring has never been assessed, is the polluted water placed into the spring affecting the capacity and operation of the Waimanalo plant injection wells?

It appears from the review of the Prelim and Supplement Reports that a substantial sum of taxpayer money is going to be expended to, or because of, process water reclaimed by a private enterprise - Unisyn.

The University of Hawai'i College of Tropical Agriculture has indicated it will not use treated effluent as irrigation as treated effluent spoils the experimental base line and is unfair to farmers that do not have access to effluent water. What is the impact on the disposal plan when 1/2 of the planned effluent acreage is removed?

To operate properly the Waimanalo STP needs less sediment in the injection wells, less infiltration from the east side of the system and new self-cleaning injection wells - less than 2 million dollars to operate at the originally published 1.1 million design capacity of 1970. Could the Waimanalo plant become a preliminary treatment plant and pumping station sending sewage to Kapaa for resource recovery (energy and reusable wastewater) with the existing wells used for emergency overflows?

Thank you,

Joseph N. A. Ryan Jr.
Owner

cc. Governor, State of Hawai'i
c/o OEQC

sevens jr

DEPARTMENT OF WASTEWATER MANAGEMENT
CITY AND COUNTY OF HONOLULU
540 SOUTH KING STREET
HONOLULU, HAWAII 96813



JEREMY HARRIS
DIRECTOR

BENJAMIN E. SPADOLLO, P.E., Ph.D.
DIRECTOR
CHERYL K. OLUNA SCHE
DEPUTY DIRECTOR

WPP 98-236

May 21, 1998

Mr. Joseph N.A. Ryan, Jr.
Hilltop Equestrian Centre
P.O. Box 562
Waimanalo, Hawaii 96795

Dear Mr. Ryan:

Subject: Supplemental Environmental Impact Statement Preparation
Notice for Waimanalo Wastewater Facilities Plan
Koolauloko, Oahu, Hawaii

Thank you for your letter of March 7, 1998 regarding the subject project. We fully appreciate your concerns and would like to take this opportunity to address them. We will address your comments generally in the order in which they were presented in your letter. We will avoid replicating responses to similar comments included more than once in your letter.

Cumulative Regional Impacts

On the first page of your letter, you point out the need to evaluate the cumulative environmental impacts in the region, including those associated with the Unisyn blowaway processing facility. We fully agree that there is a need to perform a regional study to assess the impacts of various pollutant sources.

We feel it would be prudent to identify waste loadings from the various sources and their relative impacts on water quality. This would allow future expenditure of limited pollution control funds in the most cost-effective manner. The City and County of Honolulu Department of Wastewater Management (WWM) is primarily tasked to provide wastewater collection, treatment and disposal services and does not have funding to perform extensive regional water quality, watershed management and pollution control studies. Due to the fiscal problems facing the State, it is our understanding that the State Department of Health (DOH) also does not have manpower or funding to perform these studies. Such studies, however, could be funded by the Kailua Bay Advisory Council utilizing funds that were derived from Kailua Wastewater Treatment Plant lawsuit. It is our understanding that a member of the Waimanalo Neighborhood Board has been in contact with the Kailua Bay Advisory Council and that securing at least some funds for investigations in Waimanalo appears promising.

Mr. Joseph N.A. Ryan, Jr.
Page 2
May 21, 1998

In particular, we feel that there is need to assess the sources of nutrients, particularly nitrogen in the form of nitrates, within the Waimanalo watershed and their relative impacts on water quality. Sources of nitrogen in Waimanalo include agricultural fertilizers, animal and other agricultural wastes, cesspools and septic tank systems, effluent from the Waimanalo Wastewater Treatment Plant (WWTP), decaying vegetation, and stormwater runoff. The groundwater in Waimanalo exhibits high levels of nitrates and the coastal waters of Waimanalo have experienced periodic algal blooms.

Our facilities plan recommends that future improvements at the Waimanalo WWTP incorporate a wastewater treatment process to remove nitrogen. Nitrogen removal is widely practiced throughout the U.S. and is now very cost-effective due to recent advances in treatment technology. Furthermore, many farmers favor reclaimed irrigation water with low nitrogen concentrations to allow better control over the level of fertilization and plant growth. If the proposed upgrades to the Waimanalo WWTP are implemented, the nitrogen concentration of the effluent should be lower than the nitrogen concentration of the groundwater. If the effluent is used for irrigation, plant use of nitrogen in the effluent will further reduce the net discharge of nitrogen into coastal waters. We therefore view effluent reuse as a benefit to the environment.

From a public health standpoint, the proposed irrigation reuse of "R-1" quality reclaimed water from the Waimanalo WWTP should not contribute to any adverse impacts to the community, cumulative or otherwise. Due to extremely high standards imposed by the DOH on R-1 reclaimed water, any adverse impacts on public health are expected to be negligible. A high level of effluent disinfection through the use of "state-of-the-art" ultraviolet (UV) technology is proposed. Continuous monitoring of the effluent quality (turbidity) will be required to help ensure adequate disinfection and very low levels of microbiological contaminants. If the effluent fails to meet the required quality, the system would be designed to automatically divert the effluent to the injection well system for disposal. The direct application of treated effluent on edible portions of crops is not being proposed to provide an even greater margin of public health safety.

With regard to the odor problems, it would be very difficult for us to address the cumulative impacts on residents from odors in the area without significant expenditure of time, effort and funds. In addition to the Unisyn facility, there are many other sources of odors due to extensive agricultural activities in the area. Plant operations personnel indicate that the Waimanalo Wastewater Treatment Plant has not received any complaints of odors originating at the plant in the past ten years.

We do not have sufficient information and resources to investigate the impacts of the Unisyn facility effluent and odor discharges. It would be difficult to justify the expenditure of public funds by WWM to investigate the impacts of a specific private facility. It is our understanding that Unisyn is currently preparing an environmental assessment to secure necessary City Permits for its facilities.

Mr. Joseph N.A. Ryan, Jr.
Page 3
May 21, 1998

We agree that water is a precious commodity and that effluent reuse should be encouraged. Effluent reuse is being considered at our various treatment facilities throughout Oahu. We are currently pursuing a major reuse project in the Ewa plains utilizing effluent from our Honouliuli WWTP.

Alternative Location at the Kapaa Landfill Site

Relocation of the Waimanalo WWTP to the Kapaa landfill site is not deemed cost-effective due to the need to pump the wastewater over very long distances and the high cost of relocating the treatment facilities. The cost of constructing a new treatment plant alone would be substantially higher than the \$16 million estimated cost to upgrade the existing Waimanalo WWTP.

The cost of the wastewater transmission system, which would consist of approximately 6 miles of force main and two to three pumping stations, is estimated to be over \$20 million. The use of multiple pump stations would decrease the reliability of the transmission system and increase the likelihood of wastewater spills. The long travel distances in our warm climate would likely result in septic wastewater. Septic wastewater is odorous, promotes corrosion of treatment plant components, and has adverse impacts on the treatment process.

The construction of a large regional facility to replace the Waimanalo WWTP and the Kailua Regional WWTP would decrease the treatment cost for the Waimanalo WWTP due to economy of scale. However, the relocation of the Kailua Regional WWTP is not anticipated to be cost-effective and there would be other concerns to contend with. These include substantially increased hydraulic loading on Kawaiwi Swamp during heavy rain and increased nutrient loading on the swamp ecosystem.

At the present time, we do not recommend discharge of treated municipal wastewater effluent to the Maunawili and Waimanalo irrigation systems since the direct application of reclaimed water to edible crops is not recommended by the DOH.

Since we do not recommend treatment of municipal wastewater at the Kapaa site, relocation of the Unisyn plant and treatment of the landfill leachate at the site should be considered based on their own merits. The facilities plan does suggest the Kapaa site as a possible future regional sludge composting site if current plans for a central sludge processing facility in Leeward Oahu are not implemented.

Recovery of energy from methane produced by anaerobic digesters is currently done at the Kailua Regional WWTP. The methane gas is used to operate the sludge heaters for the sludge digesters. The anaerobic digesters at the Waimanalo WWTP may also be heated by methane gas in the future. Heating of the sludge is currently not done at Waimanalo due to adequate digester performance without heating, and the need to replace the existing sludge heating equipment. The benefits of energy recovery at the Waimanalo WWTP are currently not significant due to the relatively low wastewater flow and quantity of methane production.

Mr. Joseph N.A. Ryan, Jr.
Page 4
May 21, 1998

Federal grants for municipal treatment plant projects have been very limited in recent years. Federal assistance is now being provided primarily through the establishment and funding of State Revolving Fund (SRF) loans programs. Regardless of the source of funding, water pollution control projects should be implemented on the basis of their cost-effectiveness. Our analysis indicates that conveying the wastewater from Waimanalo to the Kapaa site will not be more cost-effective than the proposed expansion of the Waimanalo WWTP and reuse of treated effluent within the Waimanalo region.

Other Concerns of the EIS

Irrigation water of R-1 quality is recommended for the Waimanalo effluent since under current DOH guidelines, the use of lower quality R-2 effluent would require a 500-foot wide buffer zone that would not be feasible in Waimanalo. Relative to the Unisyn discharge, a much higher level of treatment is justified for the Waimanalo WWTP as we are processing domestic wastewater which may contain significant concentrations of human pathogens prior to treatment. It is our understanding that Unisyn does not accept human wastes (i.e., pumpage from cesspools and septic tanks) for processing and therefore pathogens are less of a concern. Unisyn will ultimately need to address their own specific wastewater treatment and disposal needs.

We certainly appreciate your concern on the reported 3,000 CFU per 100 mL of fecal coliform and 28,000 CFU per 100 mL of total coliform in the Wing King reservoir water sample. It should be noted that coliform (both total and fecal) are abundant in Hawaii's soils, and high total and fecal coliform values do not necessarily indicate a significant health hazard or pollution concern. As noted in the facilities plan, high levels of fecal coliform (which is a subgroup of total coliform) have been recorded in Waimanalo Stream. Values as high as 69,600, 136,000, and 300,000 CFU/100 mL have been reported. Researchers at the University of Hawaii have been urging the Department of Health to adopt *Clostridium Perfringens* as a bacteriological indicator due to the natural abundance of coliform in our local soils. Responsibility for determining the safety of the Wing King reservoir water ultimately rests with the DOH.

The corrected tax map key number for the proposed effluent reservoir is 4-01-26:03. You are correct in stating that there is inadequate room for the proposed new 3.5 million gallon two-cell reservoir on the 1.9 acre Wing King reservoir site. The State Department of Agriculture (DOA) has indicated that a portion of the adjacent State-owned land leased to Unisyn (TMK 4-01-26:4) will also be used for the reservoir. The effluent reservoirs will not be located on University of Hawaii AG-1 land.

There are no plans to accept Unisyn wastewater or effluent at the Waimanalo WWTP. The DOA, as the purveyor of the irrigation water, however, has the prerogative of accepting Unisyn's effluent in their irrigation reservoirs. We anticipate DOA will require Unisyn to meet minimum levels of effluent quality to comply with DOH requirements and ensure public health safety.

Mr. Joseph N.A. Ryan, Jr.
Page 5
May 21, 1998

With regards to the spring within the Wing King Reservoir, we would not expect the spring to affect the capacity or operation of the Waimanalo WWTP effluent disposal wells. The capacity of the wells is affected by clogging occurring at the well face or in the immediate vicinity of the wells.

The DOA is primarily interested in the use of the Waimanalo WWTP effluent because it is a consistent and relatively reliable source of water during dry periods. The distribution of the reclaimed water among the various potential users is uncertain at this time. The DOA feels that the University of Hawaii College of Tropical Agriculture experimental station may have a use for reclaimed water at a later date since there may be a substantial amount of research in the future on the use of reclaimed water. The DOA has indicated to us that if water is not used by the UH experimental station, there are a number of other users not mentioned in the facilities plan that are likely to be interested in the water. There are some lands that are currently not irrigated or used for farming due to shortage of water during the dry season. We assume that Unisyn will be coordinating its reuse requirements with DOA if it intends to rely on irrigation of farm lots in the area.

We hope that we have adequately addressed your concerns. If there are any questions, please feel free to contact me or either one of our project engineers, Mr. Carl Arakaki at 523-4671, or Mr. Robert Miyasaki at 527-5159. Thank you very much for your interest in this project.

Sincerely,



KENNETH E. SPRAGUE
Director

City and County of Honolulu GIS

Zoning Designations, NB 32: Waimanalo

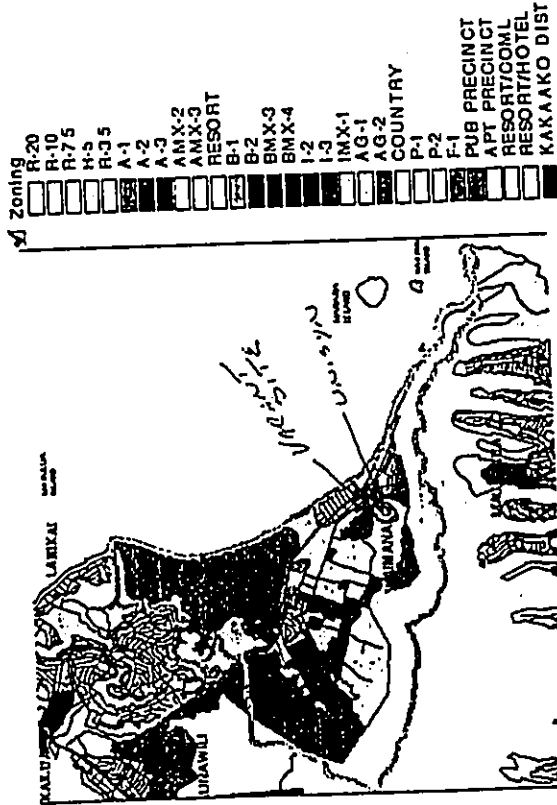

Return to Zoning Index Map

Return to: [Table of Contents](#)

Home: [City Council](#) | [Assessors](#) | [Site Directory](#)

City and County of Honolulu, Hawaii

This web site is maintained by the City GIS, Department of Land Utilization

RECEIVED

'98 JUN 12 10:15

DEPT. OF
WASTEWATER
MANAGEMENT

JOSEPH N. A. RYAN, JR.
P.O. Box 562
WAIMANALO, HAWAII 96795
(808) 259-8463
(808) 259-6670

June 10, 1998

Dr. Kenneth E. Sprague
Director
Department of Wastewater Management
630 S. King Street, 3rd Floor
Honolulu, Hawaii 96813

RE: Response to your letter of May 21, 1998; Supplemental Environmental Impact Statement Preparation Notice for Waimanalo Wastewater Facilities Plan Koolau, Oahu, Hawaii

Dear Dr. Sprague:

Thank you for allowing me the opportunity to comment on the Waimanalo Wastewater Facilities Plan and your comprehensive answer to my letter.

In your May 21, 1998, response you state:

"...there is inadequate room for the proposed new 3.5 million gallon two-cell reservoir on the 1.9 acre Wing King reservoir site. The State Department of Agriculture (DOA) has indicated that a portion of the adjacent State-owned land leased to Unisyn (TMK 4-01-26:4) will also be used for the reservoir." (pg 4, para 4)

The site proposed for the wastewater holding pond is on prime agricultural land classified AG-1 by the City and County. The proposed site is also uphill from the sewage treatment plant and requires compensation to the lessee for the reacquisition of the state-owned lease or lease portion. Construction of the proposed reservoir on the Unisyn site will require the fresh water springs in the area to be altered and fill material capable of supporting the tonnage of a lined reservoir to be imported to the site, increasing construction costs passed to taxpayers.

There is a vacant parcel of AG-2 land located makai (north) of Hihimanu Street and between the waste transfer station and Inoaole Stream. This property appears to have a solid base appropriate for the construction of a lined two-cell reservoir, would not require the City to expend money to pump water uphill, and still provide water to the DOA for irrigation purposes. This site is located along the main transmission line of the DOA's irrigation water and appears to be a cheaper alternative.

What, if any, consideration has been given to this viable alternative?

Respectfully,

Joseph N. A. Ryan Jr.

Enclosure

JOE and TAMARIE RYAN
HILLTOP RANCH
P.O. BOX 562
WAIMANALO, HI 96795

DEPARTMENT OF ENVIRONMENTAL SERVICES
DEPARTMENT OF WASTEWATER MANAGEMENT
CITY AND COUNTY OF HONOLULU
810 SOUTH KING STREET
HONOLULU, HAWAII 96813



JEFFREY HARRIS
DIRECTOR

July 13, 1998

Mr. Joseph N.A. Ryan, Jr.
Hilltop Equestrian Centre
P.O. Box 562
Waimanalo, Hawaii 96795

Dear Mr. Ryan:

Subject: Supplemental Environmental Impact Statement Preparation
Notice for Waimanalo Wastewater Facilities Plan
Koolauropoko, Oahu, Hawaii

Thank you for your letter of June 10, 1998 regarding the location of the effluent reservoir for subject project. Since the State of Hawaii, Department of Agriculture (DOA) will be responsible for the construction of the reservoir, your letter was forwarded to the DOA by our consultant. Attached is a copy of the response letter from Mr. Paul Matsuo of DOA. We hope that the DOA letter adequately addresses your concerns on the selection of the reservoir site.

If there are any questions, please feel free to contact me or our project engineer, Mr. Carl Arakaki at 523-4671. Thank you very much for your interest in this project.

Sincerely,

KENNETH E. SPRAGUE
Director

Attachment

IRBB 128

BENJAMIN J. CAVEIANO
Governor



State of Hawaii
DEPARTMENT OF AGRICULTURE
1428 South King Street
Honolulu, Hawaii 96814-2512

June 30, 1998

Mr. Roy Abe, P.E.
Hawaii Pacific Engineers
1132 Bishop Street, Suite 1003
Honolulu, HI 96813-2830

Dear Mr. Abe:

This is in response to your faxed memorandum of June 16, 1998 regarding the Waimanalo Wastewater Facilities Plan. The following are our comments to Mr. Joseph N. A. Ryan, Jr.'s June 10th letter:

1. Alternate reservoir site. The reason is twofold: first, the site isn't under our control and second, it will not gravity feed into our distribution system due to elevation differences (means we will need to have two separate pump stations, one to get the sewerage effluent, then another to inject under pressure into our distribution pipeline).
2. Energy is a major concern for our system. The reason is not only the power costs, but also the maintenance of electrical equipment due to constant use.
3. Compensation to the existing lessee is not a problem as we have a working agreement on the use of the site in exchange for acceptance of their roof runoff and wash water.
4. Springs that occur will not be affected by our twin cell reservoir as they are in another location, away from the springs.

I would not feel comfortable agreeing that the reservoir is an unresolved issue. This will jeopardize our federal watershed agreement status and may result in the loss of federal assistance.

Thank you for allowing us to provide our views on the matter. If there are any questions, please call me at 973-9473.

Sincerely,

PAUL T. MATSUO, P.E.
Administrator-Chief Engineer
Agricultural Resource Management
Division

cc: WRCS
Chairperson, Board of Agriculture
Waimanalo I.S.



DEPARTMENT OF WASTEWATER MANAGEMENT
CITY AND COUNTY OF HONOLULU
150 SOUTH KING STREET, 3RD FLOOR • HONOLULU, HAWAII 96813
PHONE: (808) 521-6663 • FAX: (808) 521-6675



KENNETH E. SPRAGUE P.E., Ph.D.
DIRECTOR
CIVIL & DRUMMA ENGINEERS, INC.
STRUCTURAL ENGINEERS

WPP 98-204

GTE Hawaii Tel
P.O. Box 2200 • Honolulu, HI 96811 • TEL: 548-5111

RECEIVED
FEB 11 1999
HAWAII PACIFIC
ENGINEERS, INC.

February 9, 1998

GTE Hawaii Tel
Beyond the call

Mr. Roy Abe
Hawaii Pacific Engineers, Inc.
1132 Bishop Street, Suite 1003
Honolulu, HI 96813-2830

Dear Roy,

Thank you for sharing a copy of the "Supplemental Environmental Impact Statement Preparation Notice for Waimanalo Wastewater Facilities Plan" document.

Item 7 on page 33 discusses the temporary disruption of utility service by the construction activities. Please contact our telephone cable permit group at 483-8085 to identify existing lines in the field. This will minimize accidental damage to our extensive network.

It is not necessary to include GTE Hawaiian Tel during the remainder of the EIS review process.

I appreciate the opportunity to communicate my concern.

Very truly yours,

Harlan Hashimoto
Environmental Affairs

Mr. Harlan Hashimoto
GTE Hawaiian Tel
P.O. Box 2200
Honolulu, Hawaii 96841

Dear Mr. Hashimoto:

Subject: Supplemental Environmental Impact Statement Preparation
Notice for Waimanalo Wastewater Facilities Plan
Koolauloko, Oahu, Hawaii

Thank you for your letter of February 9, 1998, to Hawaii Pacific Engineers, Inc. regarding the subject project.

Please be assured that your telephone cable permit group will be contacted during the design and construction phases to identify existing lines in the field and minimize damage to your network.

Should you desire any additional information on the project, please feel free to contact me or either one of our project engineers, Mr. Carl Arakaki at 523-4671, or Mr. Robert Miyasaki at 527-5159.

Sincerely,

KENNETH E. SPRAGUE

Kenneth E. Sprague
Director

cc: Hawaii Pacific Engineers, Inc.

Hawaiian Electric Company, Inc. • P.O. Box 2750 • Honolulu, HI 96840-0001

RECEIVED
FEB 27 1998

HAWAII PACIFIC
ENGINEERS INC.



Patricia Uehara Wong, Esq.
Manager,
Environmental Department

February 25, 1998

Roy K. Abe
Hawaii Pacific Engineers, Inc.
1132 Bishop Street, Suite 1003
Honolulu, HI 96813-2830

Dear Mr. Abe

Subject: Waimanalo Wastewater Facilities

Thank you for the opportunity to comment on your January 1998 Supplemental EIS for the Waimanalo Wastewater Facilities, as proposed by the Department of Wastewater Management, City and County of Honolulu. We have reviewed the subject document and have no comments at this time.

HECO shall reserve further comments pertaining to the protection of existing powerlines bordering the project area until construction plans are finalized. Again, thank you for the opportunity to comment on this draft environmental assessment.

Sincerely,

cc: Department of Wastewater Management
City and County of Honolulu
650 South King Street, 8th Floor
Honolulu, HI 96813



WINNER OF THE EDISON AWARD
FOR DISTINGUISHED INDUSTRY LEADERSHIP

DEPARTMENT OF WASTEWATER MANAGEMENT
CITY AND COUNTY OF HONOLULU
650 SOUTH KING STREET, 8TH FLOOR • HONOLULU, HAWAII 96813
PHONE: (808) 527-6643 • FAX: (808) 527-6373



JEREMY HARRIS
SEALER

KENNETH E. SPRAGUE P.E., Ph.D.
DIRECTOR
CHERYL K. OJUMA SEPE, MS
DEPUTY DIRECTOR

WPP 98-205

April 9, 1998

Patricia Uehara Wong, Esq.
Manager, Environmental Department
Hawaiian Electric Co.
P.O. Box 2750
Honolulu, Hawaii 96840-0001

Dear Ms. Uehara Wong:

Subject: Supplemental Environmental Impact Statement Preparation
Notice for Waimanalo Wastewater Facilities Plan
Koolaulaopoko, Oahu, Hawaii

Thank you for your letter of February 25, 1998, to Hawaii Pacific Engineers, Inc. regarding the subject project.

HECO will be contacted during the design and construction phases to ensure adequate protection of powerlines in affected areas.

We will provide you with a copy of the Draft Supplemental Environmental Impact Statement (DSEIS) upon it is completion. We look forward to your agency's continued participation as a consulted party. If there are any questions, please feel free to contact me or either one of our project engineers, Mr. Carl Arakaki at 523-4671, or Mr. Robert Miyasaki at 527-5159. Thank you very much for your interest in this project.

Sincerely,

CHERYL K. OJUMA SEPE
For
KENNETH E. SPRAGUE
Director

cc: Hawaii Pacific Engineers, Inc.

LIST OF ORGANIZATIONS/PERSONS CONSULTED AND COPIES OF DSEIS COMMENT/RESPONSE LETTERS

The organizations and persons listed below were consulted in preparation of the Final Supplemental EIS (FSEIS). In addition to distribution of the DSEIS to the various agencies, organizations and individuals, copies of the document were also made available to the general public at the various public libraries listed below. Those marked with an asterisk (*) sent written comments on the DSEIS. The letters and responses are reproduced on the pages which follow in the order listed below.

City and County of Honolulu 4 copies DSEIS

- Council Member John Henry Felix, District III
- Board of Water Supply*
- Department of Environmental Services
- Department of Facility Maintenance
- Department of Parks and Recreation Services*
- Department of Planning and Permitting* 4
- Department of Transportation Services*
- Planning Department*
- Municipal Reference & Records Center

substantive

State of Hawaii 6

- Senator Whitney Anderson, District 25
- Representative Kenny Goodenow, District 51
- Department of Accounting and General Services*
- Department of Agriculture
- Department of Business, Economic Development & Tourism
- Department of Business, Economic Development & Tourism, Energy, Resources & Technology Division
- Department of Business, Economic Development & Tourism, Housing and Finance Development Corporation*
- Department of Business, Economic Development & Tourism, Office of Planning*
- Department of Defense
- Department of Hawaiian Home Lands
- Department of Health, Environmental Planning Office
- Department of Land and Natural Resources, Land Division*
- Department of Land and Natural Resources, State Historic Preservation Division*
- Department of Transportation*
- Office of Environmental Quality Control*
- Office of Hawaiian Affairs
- University of Hawaii, Environmental Center*

**LIST OF ORGANIZATIONS/PERSONS CONSULTED AND COPIES OF DSEIS
COMMENT/RESPONSE LETTERS**

The organizations and persons listed below were consulted in preparation of the Final Supplemental EIS (FSEIS). In addition to distribution of the DSEIS to the various agencies, organizations and individuals, copies of the document were also made available to the general public at the various public libraries listed below. Those marked with an asterisk (*) sent written comments on the DSEIS. The letters and responses are reproduced on the pages which follow in the order listed below.

City and County of Honolulu

4 p. DSEIS

Council Member John Henry Felix, District III
Board of Water Supply*
Department of Environmental Services
Department of Facility Maintenance
~~Department of Parks and Recreation Services*~~
Department of Planning and Permitting*
Department of Transportation Services*
Planning Department*
Municipal Reference & Records Center

Substantive

4

State of Hawaii

6

Senator Whitney Anderson, District 25
Representative Kenny Goodenow, District 51
~~Department of Accounting and General Services*~~
Department of Agriculture
Department of Business, Economic Development & Tourism
Department of Business, Economic Development & Tourism,
Energy, Resources & Technology Division
Department of Business, Economic Development & Tourism,
~~Housing and Finance Development Corporation*~~
Department of Business, Economic Development & Tourism,
Office of Planning*
Department of Defense
Department of Hawaiian Home Lands
Department of Health, Environmental Planning Office
~~Department of Land and Natural Resources, Land Division*~~
Department of Land and Natural Resources, State Historic Preservation Division*
Department of Transportation*
Office of Environmental Quality Control*
Office of Hawaiian Affairs
University of Hawaii, Environmental Center*

State of Hawaii (continued)

University of Hawaii, Water Resources Research Center
 University of Hawaii at Manoa Marine Programs
 Department of Business, Economic Development & Tourism Library
 Hawaii State Library
 Kaneohe Regional Library
 Legislative Reference Bureau
 University of Hawaii at Manoa Hamilton Library, Hawaiian Collection
 Waimanalo Public & School Library

U.S. Government 2

Bellows Air Force Station
~~Department of Agriculture, Natural Resources Conservation Service*~~
~~Department of the Army, U.S. Army Engineer District, Honolulu*~~
~~Department of Interior, Fish and Wildlife Service*~~
~~Department of Interior, Geological Survey*~~
 Department of the Navy, Commander, Naval Base Pearl Harbor*
 Marine Corps Base Hawaii, Kaneohe Bay
 National Marine Fisheries Service
 U.S. Environmental Protection Agency, Pacific Islands Contact Office

Community Groups and Organizations, Other Interested Parties |

Waimanalo Hawaiian Homes Association
 Waimanalo Homes Residents Association
 Waimanalo Neighborhood Board No. 32
 Waimanalo Neighborhood Board, Wastewater Advisory Committee
 Waimanalo Water Quality Committee, c/o The Hawaii Community Foundation
 Hilltop Equestrian Centre*
 Kailua Bay Advisory Council
 Kailua Neighborhood Board, Planning and Zoning Committee
 Koolaupoko-Community-Development-Plan-Goalition,-Infrastructure-&-Facilities
 Committee*
 Olomana Golf Links
 Save Our Bays and Beaches
 Waimanalo News
 Honolulu Star Bulletin
 The Honolulu Advertiser

Public Utility Agencies

~~Hawaiian Electric Company*~~

BOARD OF WATER SUPPLY
CITY AND COUNTY OF HONOLULU
600 SOUTH BERETANIA STREET
HONOLULU, HAWAII 96843
PHONE (808) 527-6180
FAX (808) 533-2714



RECEIVED

SEP 18 AM 9:56

September 11, 1998

DESIGN & CONSTRUCTION
DIVISION OF
WATER SUPPLY

JEREMY HARRIS, Mayor
EDDIE FLORES, Jr., Chairman
FOREST C. MURPHY, Vice Chairman
KAZU HIRASHIMA
JAN LILLY, AIE
JOHNATHAN K. SHIMADA, PhD
BARBARA KIM STANTON
CHARLES A. STED

CLIFFORD S. JAMBLE
Manager and Chief Engineer

TO: RANDALL K. FUJIKI, DIRECTOR
DEPARTMENT OF DESIGN AND CONSTRUCTION

FROM: *Clifford S. Jamble*
CLIFFORD S. JAMBLE, MANAGER AND CHIEF ENGINEER
BOARD OF WATER SUPPLY

SUBJECT: YOUR MEMORANDUM OF AUGUST 3, 1998 REGARDING THE DRAFT
SUPPLEMENTAL ENVIRONMENTAL IMPACT STATEMENT FOR THE
PROPOSED WAIMANALO WASTEWATER FACILITIES PLAN,
KOOLAUPOKO, OAHU, HAWAII

Thank you for the opportunity to review and comment on the draft supplemental environmental impact statement for the proposed Waimanalo Wastewater Facilities plan.

We have the following comments:

1. The existing water system is presently adequate to accommodate the proposed Waimanalo treatment plant upgrade. However, the system cannot provide adequate fire protection to the Kahawai pump station site. The applicant will be required to install a fire hydrant in the vicinity of the pump station. The construction drawings should be submitted for our review and approval.
2. There is an existing 3-inch water meter serving the Waimanalo Wastewater Treatment Plant and an existing 1 1/2-inch water meter serving the Kahawai Stream Wastewater Pump Station.
3. The availability of water will be confirmed when the building permit applications are submitted for our review and approval. When water is made available, the applicant will be required to pay our Water System Facilities Charges for resource development, transmission and daily storage.
4. If a 3-inch or larger meter is required, the construction drawings showing the installation of the meter should be submitted for our review and approval.

Randall K. Fujiki
Page 2
September 11, 1998

5. The on-site fire protection requirements should be coordinated with the Fire Prevention Bureau of the Honolulu Fire Department.
6. Board of Water Supply approved reduced pressure principle backflow prevention assemblies will be required to be installed after all domestic water meters serving the project site.

If you have any questions, please contact Barry Usagawa at 527-5235.

DEPARTMENT OF DESIGN AND CONSTRUCTION
CITY AND COUNTY OF HONOLULU

650 SOUTH KING STREET, 2ND FLOOR
HONOLULU, HAWAII 96813
PHONE: (808) 523-4564 • FAX: (808) 523-4567



JEREMY HARRIS
MAYOR

RANDALL K. FUJIKI, AIA
DIRECTOR
ROLAND D. LIBBY, JR., AIA
DEPUTY DIRECTOR

DCP 98-333

October 15, 1998

MEMORANDUM

TO: MR. CLIFFORD S. JAMILE, MANAGER & CHIEF ENGINEER
BOARD OF WATER SUPPLY

FROM: For RANDALL K. FUJIKI, DIRECTOR
DEPARTMENT OF DESIGN AND CONSTRUCTION

SUBJECT: DRAFT SUPPLEMENTAL ENVIRONMENTAL IMPACT STATEMENT (DSEIS)
FOR WAIMANALO WASTEWATER FACILITIES PLAN
KOOLAUPOKO, OAHU, HAWAII

IMK: 4-1

Thank you for reviewing the subject document and for your correspondence of September 11, 1998. We would like to take this opportunity to respond to your specific comments.

The installation of a new fire hydrant is planned for the Kahawai Stream Wastewater Pump Station as recommended. Construction plans for the water system upgrade work at the pump station and the Waimanalo Wastewater Treatment Plant (WWTP) will be submitted to the Board of Water Supply (BWS) for review and approval. We anticipate that the existing 3- and 1-1/2-inch meters serving the treatment plant and pump station will be adequate. However, a new separate 10-inch fire protection line with detector check is proposed to supply fire hydrants within the treatment plant site. The on-site fire protection requirements will be coordinated with the Fire Prevention Bureau of the Honolulu Fire Department. New BWS approved reduced pressure principle backflow prevention units will be provided as required immediately downstream of the water meter.

A copy of your letter and this response will be included in the final supplemental environmental impact statement. If there are any questions, please feel free to contact our project engineer, Mr. Carl Arakaki at 523-4671. Thank you very much for your time and consideration on this project.

cc: Office of Environmental Quality Control
✓ Roy Abe, Hawaii Pacific Engineers

DEPARTMENT OF PARKS AND RECREATION
CITY AND COUNTY OF HONOLULU
650 SOUTH KING STREET, 2ND FLOOR
HONOLULU, HAWAII 96813
PHONE: (808) 533-4564 • FAX: (808) 533-4587

SEP 22 1998
HAWAII PACIFIC
ENGINEERS INC.
WILLIAM D BALFOUR, JR
DIRECTOR
MICHAEL T KING
DEPUTY DIRECTOR



September 18, 1998

TO: RANDALL K. FUJIKI, DIRECTOR
DEPARTMENT OF DESIGN AND CONSTRUCTION

FROM: WILLIAM D. BALFOUR, JR., DIRECTOR

SUBJECT: DRAFT SUPPLEMENTAL ENVIRONMENTAL IMPACT STATEMENT
FOR WAIMANALO WASTEWATER FACILITIES PLAN
KOOLAUPOKO, OAHU, HAWAII

We have reviewed the above-referenced document and have no comment to offer at this time.

Thank you for the opportunity to review the draft supplemental environmental impact statement.

If you have any questions, please contact Mr. John Eveland, Executive Assistant, at 527-6038.

W.D. Balfour Jr.
WILLIAM D. BALFOUR, JR.
Director

MDH:CU
(9-18987)
cc: Governor, State of Hawaii
Hawaii Pacific Engineers, Inc.

DEPARTMENT OF DESIGN AND CONSTRUCTION
CITY AND COUNTY OF HONOLULU
650 SOUTH KING STREET, 2ND FLOOR
HONOLULU, HAWAII 96813
PHONE: (808) 533-4564 • FAX: (808) 533-4587



October 15, 1998

MEMORANDUM

TO: MR. WILLIAM D. BALFOUR, JR., DIRECTOR
DEPARTMENT OF PARKS & RECREATION SERVICE

FROM: For RANDALL K. FUJIKI, DIRECTOR
DEPARTMENT OF DESIGN AND CONSTRUCTION

SUBJECT: DRAFT SUPPLEMENTAL ENVIRONMENTAL IMPACT STATEMENT (DSEIS)
FOR WAIMANALO WASTEWATER FACILITIES PLAN
KOOLAUPOKO, OAHU, HAWAII
TMK: 4-1

Thank you for reviewing the subject document and for your correspondence of September 18, 1998. We acknowledge that the Department of Parks and Recreation has no comments to offer at this time.

A copy of your letter and this response will be included in the final supplemental environmental impact statement. If there are any questions, please feel free to contact our project engineer, Mr. Carl Arakaki at 523-4671. Thank you very much for your time and consideration on this project.

cc: Office of Environmental Quality Control
Roy Abe, Hawaii Pacific Engineers

RANDALL K. FUJIKI, AIA
DIRECTOR
ROLAND D. LEBY, JR., AIA
DEPUTY DIRECTOR

DCP 98-334

RECEIVED
SEP 23 1998

DEPARTMENT OF PLANNING AND PERMITTING
CITY AND COUNTY OF HONOLULU
630 SOUTH KING STREET • HONOLULU, HAWAII 96813
PHONE: (808) 525-4616 • FAX: (808) 525-4743

HAWAII PACIFIC
ENGINEERS INC.

RANDALL K. FUJIKI, DIRECTOR
Page 2
September 22, 1998



JAN NAOE SULLIVAN
DIRECTOR
LORETTA L. C. CHEE
DEPUTY DIRECTOR

98-05917(ST)
'98 EA Comments Zone 4

September 22, 1998

MEMORANDUM

TO: RANDALL K. FUJIKI, DIRECTOR
DEPARTMENT OF DESIGN AND CONSTRUCTION

ATTN: CARL ARAKAKI

FROM: JAN NAOE SULLIVAN, DIRECTOR
DEPARTMENT OF PLANNING AND PERMITTING

SUBJECT: DRAFT SUPPLEMENTAL ENVIRONMENTAL IMPACT STATEMENT (SEIS):
WAIMANALO WASTEWATER FACILITIES PLAN, WAIMANALO, OAHU
TAX MAP KEYS: 4-1-3 VARIOUS

We have reviewed the Draft SEIS for the above-referenced plan received on August 5, 1998, and provide the following comments:

- There appears to be some missing text in the second paragraph on page S-2.
- All work within City rights-of-way will require that construction and traffic control plans be submitted to our Traffic Review Branch for review and approval. The traffic control plans should include incremental work for specific segments of the roadway during the various phases of construction.
- Construction work which may need to occur outside of normal working hours should be coordinated with the City, prior to submittal of construction plans.
- SUMMARY OF REQUIRED APPROVALS (page 4-14): We note that a Notice of Intent (NOI) should be filed with the State Department of Health (DOH) along with the submittal of a construction dewatering permit.

The City and County of Honolulu Permits/Approvals, the listing of permits and approvals on pages S-6 and 4-15, incorrectly indicates that a Permit to Discharge Effluent (temporary) is the responsibility of this Department. These listings in the final SEIS should be revised to correctly indicate that this permit is the responsibility of the Department of Environmental Services.

We have no other comments to offer at this time. Should you have any questions, please contact Steve Tagawa of our Coastal Lands Branch at 523-4817.

JAN NAOE SULLIVAN
JAN NAOE SULLIVAN
Director of Planning
and Permitting

JNS:am
cc: Roy Abe, Hawaii Pacific Engineers, Inc.
Gary Gill, Office of Environmental
Quality Control
914900317.doc

DEPARTMENT OF DESIGN AND CONSTRUCTION
CITY AND COUNTY OF HONOLULU

650 SOUTH ERIG STREET, 2ND FLOOR
HONOLULU, HAWAII 96813
PHONE: (808) 523-4554 • FAX: (808) 523-4567



JEREMY HARRIS
MAYOR

RANDALL K. FUJIKI, AIA
DIRECTOR
ROLAND D. LIBBY, JR., AIA
DEPUTY DIRECTOR

DCP 98-335

October 15, 1998

MEMORANDUM

TO: MS. JAN NAOE SULLIVAN, DIRECTOR
DEPARTMENT OF PLANNING & PERMITTING

FROM: RANDALL K. FUJIKI, DIRECTOR
DEPARTMENT OF DESIGN AND CONSTRUCTION

SUBJECT: DRAFT SUPPLEMENTAL ENVIRONMENTAL IMPACT STATEMENT (DSEIS)
FOR WAIMANALO WASTEWATER FACILITIES PLAN
KOO LAUPOKO, OAHU, HAWAII
TMK: 4-1

Thank you for reviewing the subject document and for your correspondence of September 22, 1998. We offer the following responses to your comments:

- 1) The last sentence of the second paragraph on page S-2 of the DSEIS will be revised to read: "The capital cost of the sewers, excluding the cost of lateral sewers within private property, is estimated to be approximately \$16,000 per home."
- 2) Construction and site specific traffic control plans will be submitted to your Site Development Division for review and approval. Any construction work which may need to occur outside of normal working hours will be coordinated with the Department of Transportation Services prior to submittal of the construction plans.
- 3) To better reflect the NPDES permitting requirements, "NPDES stormwater permit" on pages S-5 and 4-15 of the DSEIS will be revised to "NPDES permit (construction dewatering and storm water runoff from a construction site)." We acknowledge your comment on the need to submit a Notice of Intent (NOI) to the State Department of Health as part of the NPDES permit process.
- 4) In accordance with your comment, the text citing the Permit to Discharge Effluent (Temporary) in the list of permits and approvals on pages S-6 and 4-15 of the DSEIS will be revised to read:

"Permit to Discharge Effluent
(temporary)

Department of Environmental
Services"

Ms. Jan Naoe Sullivan
October 15, 1998
Page 2

A copy of your letter and this response will be included in the final supplemental environmental impact statement. If there are any questions, please feel free to contact our project engineer, Mr. Carl Arakaki at 523-4671. Thank you very much for your time and consideration on this project.

cc: Office of Environmental Quality Control
✓ Roy Abe, Hawaii Pacific Engineers

RECEIVED

DEPARTMENT OF TRANSPORTATION SERVICES

CITY AND COUNTY OF HONOLULU SEP 29 1998

PACIFIC PAPER PLANT • 3115 KAPOLAHUA BOULEVARD SUITE 1200 • HONOLULU, HAWAII 96813

PHONE: (808) 533-4329 • FAX: (808) 533-4730

HAWAII PACIFIC ENGINEERS INC.

Randall K. Fujiki
September 23, 1998
Page 2



SECRETARIES
MAIL ROOM

CHERYL D. SOON
DIRECTOR
JOSEPH M. MAGALON
DEPUTY DIRECTOR

September 24, 1998

TPD8/98-04644R

MEMORANDUM

TO: RANDALL K. FUJIKI, DIRECTOR
DEPARTMENT OF DESIGN AND CONSTRUCTION

ATTN: CARL ARAKAKI

FROM: CHERYL D. SOON, DIRECTOR

SUBJECT: WAIHANAIO WASTEWATER FACILITIES PLAN

In response to your August 3, 1998 memorandum, the draft supplemental environmental impact statement (SEIS) for the subject project was reviewed. The following comments are the result of this review:

1. We believe that the discussion regarding Traffic and Public Safety Impacts on Pages 5-33 and 5-34 is acceptable for the draft SEIS. However, as the project becomes more defined as it progresses towards implementation, site-specific anticipated traffic impacts during construction and their proposed mitigation measures need to be detailed and coordinated with this department.

Area residents and the neighborhood board should be apprised of the project and its traffic impacts prior to its commencement. Any required closure of private driveways should be coordinated with affected property owners prior to such closure.

Should any detours or street closures be required during the construction phase of this project, the emergency services (fire, ambulance and police) should be notified prior to implementation of the detours or street closures. We also ask that this department be notified so that we can then alert Oahu Transit Services of the construction activity.

If the public right-of-way is planned to be used for parking and temporary storage of vehicles and construction equipment during the construction phase, pedestrian safety (i.e., adequate and safe sidewalk widths) and adequate visibility at intersections, etc., need to be ensured.

2. As of July 1, 1998, construction plans and their related traffic control plans are being reviewed for approval by the Department of Planning and Permitting (DPP). Therefore, these plans should be transmitted to DPP upon their completion.

Should you have any questions regarding these comments, please contact Faith Miyamoto of the Transportation Planning Division at Local 6976.

Cheerful Soon
CHERYL D. SOON

cc: Office of Environmental
Quality Control
Mr. Roy Abe, Hawaii Pacific Engineers

DEPARTMENT OF DESIGN AND CONSTRUCTION
CITY AND COUNTY OF HONOLULU
650 SOUTH KING STREET, 2ND FLOOR
HONOLULU, HAWAII 96813
PHONE: (808) 522-4564 • FAX: (808) 523-4587



RAIMOND E. FUJIKI, AIA
DIRECTOR
ROLAND D. LEBBY, JR., AIA
DEPUTY DIRECTOR

DCP 98-337

October 15, 1998

MEMORANDUM

TO: MS. CHERYL D. SOON, DIRECTOR
DEPARTMENT OF TRANSPORTATION SERVICES

FROM: For RAIMOND E. FUJIKI, DIRECTOR
DEPARTMENT OF DESIGN AND CONSTRUCTION

SUBJECT: DRAFT SUPPLEMENTAL ENVIRONMENTAL IMPACT STATEMENT (DSEIS)
FOR WAIMANALO WASTEWATER FACILITIES PLAN
KOOLAUPOKO, OAHU, HAWAII
TMK: 4-1

Ms. Cheryl D. Soon
October 15, 1998
Page 2

A copy of your letter and this response will be included in the final supplemental environmental impact statement. If there are any questions, please feel free to contact our project engineer, Mr. Carl Arakaki at 523-4671. Thank you very much for your time and consideration on this project.

cc: Office of Environmental Quality Control
✓ Roy Abe, Hawaii Pacific Engineers

Thank you for reviewing the subject document and for your correspondence of September 24, 1998. Based on your comments, we will revise the discussion on traffic and public safety impacts presented on pages 5-33 and 5-34 of the DSEIS to include the following additional impact mitigation measures (shown in italics):

- *Informing affected residents and the neighborhood board of the project and its traffic impacts prior to the commencement of construction. Coordination by the contractor and the City on closure of private driveways with the affected property owners prior to the closure.*
- *Barriers, cones, signage, lighting, non-skid covering over trenches, adequate and safe sidewalk widths, adequate intersection visibility, and other provisions to promote safe passage of vehicles and pedestrians through the construction zone.*
- *Notification of emergency services (fire, ambulance and police) prior to implementation of any required detours or street closures. Notification of the City Department of Transportation Services to allow the City to alert Oahu Transit Services of the construction activity.*

The construction plans and their related traffic control plans will be transmitted to the Department of Planning and Permitting as indicated in your comments.

RECEIVED
AUG 14 1998

PLANNING DEPARTMENT
CITY AND COUNTY OF HONOLULU
630 SOUTH KING STREET, SUITE 1000 • HONOLULU, HAWAII 96813-3017
PHONE: (808) 525-5922 • FAX: (808) 525-4750

HAWAII PACIFIC
ENGINEERS INC.



PATRICK T. ONISH
CHIEF PLANNING OFFICER
DONALD L. WARRICK
DEPUTY CHIEF PLANNING OFFICER

GW 8/98-1549

August 13, 1998

TO: RANDALL K. FUJIKI, DIRECTOR
DEPARTMENT OF DESIGN AND CONSTRUCTION

FROM: PATRICK T. ONISH
CHIEF PLANNING OFFICER

SUBJECT: DRAFT SUPPLEMENTAL ENVIRONMENTAL IMPACT
STATEMENT (DSEIS) FOR WAIMANALO WASTEWATER
FACILITIES PLAN, KOOLAUPOKO, OAHU, HAWAII

We have reviewed the above-referenced DSEIS. The DSEIS recognizes that the Planning Department is currently engaged in a major revision of the Koolaupoko Development Plan, and that the revision will not be finished until after completion of the Waimanalo Wastewater Facilities Plan. Furthermore, the DSEIS states that design flows, treatment capacities and construction phasing will be re-examined during the detailed planning and engineering phase for this project, to assure consistency with the revised Koolaupoko Development Plan.

We note that statements on pages S-4, 4-10 and 9-1 indicate an expectation that revision of the Koolaupoko Development Plan will be completed by late 1998. In fact, the schedule for this project has recently been extended such that completion of a Public Review Draft is expected by December 1, 1998; actual adoption of the plan by City Council would follow extensive public review of that draft, revision of the plan as appropriate to incorporate review comments, production of a final draft, and consideration of the final draft by the Planning Commission and City Council. Therefore, it can be expected that the revised plan will not become effective until mid-1999 or later.

We have no comments to offer regarding this DSEIS. We wish to thank you, however, for extending to us the opportunity to review a preliminary draft of the DSEIS. We note you have considered the comments provided as a result of that earlier review, and that this DSEIS appropriately responds to the concerns expressed in those comments. As a means of forming a record of those comments, we have repeated them below and have noted your responses as provided in your memorandum of August 3, 1998.

Randall K. Fujiki, Director
August 13, 1998
Page 2

"1. The [preliminary] DSEIS states that installation of sewers to eliminate the use of approximately 350 individual wastewater systems in the "beach lots" area will reduce the contribution of nitrogen into Waimanalo Bay. This conclusion is not supported by the results of the study conducted as part of this planning effort, and reported on in the [preliminary] DSEIS, as those results were themselves inconclusive."

DDC Response: "We agree that investigations conducted on impacts of nutrient from individual wastewater systems are inconclusive. We therefore recommend additional studies to investigate this matter further. The State Department of Health has indicated that they would like to see the coastal area of Waimanalo sewerred despite the lack of data indicating that there will be beneficial impacts."

"2. The [preliminary] DSEIS states that individual wastewater systems in areas not proposed to be sewerred, including the Bell Street area, will need to be expanded or constructed anew. The [D]SEIS should indicate who would be responsible for accomplishing these improvements."

DDC Response: "The DSEIS has been revised to indicate that the individual homeowners will be responsible for upgrading the individual wastewater systems."

"3. The [preliminary] DSEIS states that the proposed effluent reuse will allow for additional crop production in Waimanalo. While it is true that the availability of this source of irrigation water may make it possible to bring additional lands into production, those lands will be brought into production only if that irrigation water can be delivered at reasonable cost. The [D]SEIS should address the economics of delivering this water to the target sites."

DDC Response: "The State Department of Agriculture will be responsible for pricing the reclaimed water to encourage additional agricultural production. Due to the projected high cost of the reclaimed water, it is anticipated that all users in the region will be sharing the added costs of using reclaimed water. Subsidies from other government agencies may be potentially justified due to water quality benefits and conservation of potable water resulting from reclaimed water use. The costs for reclaimed water stated in the DSEIS include estimate costs for storing, pumping and distribution of the reclaimed water. The costs are discussed in greater detail in the Waimanalo Facilities Plan report."

Randall K. Fujiki, Director
August 13, 1998
Page 3

"4. The [preliminary] DSEIS states that improvement of wastewater facilities in Waimanalo will allow additional development within the service area, and notes many potential negative impacts including further loss of the rural agricultural nature of Waimanalo. The [D]SEIS should more closely address these potential impacts and should evaluate the desirability of the proposed improvements if they will contribute to the loss of Waimanalo's existing community character."

DDC Response: "A statement has been included in the DSEIS to indicate that while the expansion of the Waimanalo wastewater facilities will allow more growth to occur, the growth is generally consistent with the City's planning policies and population projections. The wastewater facilities are being expanded to accommodate anticipated development in the area, particularly by the Department of Hawaiian Home Lands. Growth should be determined by planning policies and land use controls rather than infrastructure capacity."

"5. At page 1-1, the [preliminary] DSEIS states that Waimanalo's wastewater is collected by a network of gravity sewers. The [D]SEIS should clarify the role of the Kahawai Stream WWPS and the associated force main."

DDC Response: "The DSEIS has been revised to clarify the role of the Kahawai Stream WWPS."

"6. At page 1-9, a footnote states that more than three new injection wells may be needed. The [D]SEIS should clarify how many more might be needed and/or the criteria by which that number would be determined."

DDC Response: "The DSEIS has been revised to indicate that the number of additional disposal wells will be determined by DOH requirements. The number of additional wells is unknown at the present time since it will depend on the results of capacity testing conducted on the new and existing wells."

"7. At page 4-8, the [preliminary] DSEIS states that the existing Development Plan Public Facilities Map (DPPFM) shows existing and proposed public and private facilities. The [D]SEIS should correct this statement to indicate that the DPPFM shows approximate locations of major planned public facilities."

DDC Response: "The DSEIS has been revised to indicate that the Development Plan Public Facilities Map shows approximate locations of major planned public facilities."

Randall K. Fujiki, Director
August 13, 1998
Page 4

"8. At page 4-11, the [preliminary] DSEIS implies that the Planning Department and the Department of Land Utilization share responsibility for administration of the Land Use Ordinance. The [D]SEIS should clarify that administration of the LUO is the sole responsibility of DLU."

DDC Response: "The DSEIS has been revised to clarify that administration of the LUO is the sole responsibility of the Department of Planning and Permitting."

"9. At page 5-28, the [preliminary] DSEIS states that disposal of small quantities of used UV bulbs would be a legal alternative to bulk shipments to an off-island recycler. The [D]SEIS should address the potential cumulative effects of this alternative."

DDC Response: "The DSEIS has been revised to indicate that bulk shipment of the used UV bulbs to a mainland recycler will be the primary and only practical means of disposing the significant quantities of used bulbs."

"10. At page 2-8, the [preliminary] DSEIS states that Sewer Improvement District assessment fee is \$0.25 per square foot of lot area for residential areas. At page 5-29, this rate is cited as \$0.25 per 1,000 square feet of residential lot area. The [D]SEIS should clarify which rate is correct."

DDC Response: "The DSEIS has been revised to state that the assessment fee is \$0.25 per square foot."

"11. The DSEIS should indicate the adequacy of the 1.1 mgd Wastewater Treatment Plant to handle the projected 2020 population. An additional table to Table 3-11 and text discussion could be used to indicate the per capita design flow, total flows, and any impact of WWII measures."

DDC Response: "The DSEIS has been revised to include a discussion on the year 2020 wastewater flow projections."

Again, we note that the comments provided above were made as a result of our review of a preliminary draft of the DSEIS, and the current DSEIS appropriately responds to the concerns expressed in those comments.

If you should have any questions or concerns, please do not hesitate to contact Gordon Wood of the Planning Department staff at 527-6073.

PTO:js

cc: ✓ Roy Abe, Hawaii Pacific Engineers, Inc.

DEPARTMENT OF DESIGN AND CONSTRUCTION
CITY AND COUNTY OF HONOLULU

650 SOUTH KING STREET, 2ND FLOOR
HONOLULU, HAWAII 96813
PHONE: (808) 523-4564 • FAX: (808) 523-4567



JEREMY HARRIS
MAYOR

RANDALL K. FUJIKI, AIA
DIRECTOR
ROLAND D. LIBBY, JR., AIA
DEPUTY DIRECTOR

DCP 98-336

October 15, 1998

MEMORANDUM

TO: MR. PATRICK T. ONISHI, CHIEF PLANNING OFFICER
PLANNING DEPARTMENT

FROM: For *Randall K. Fujiki*
RANDALL K. FUJIKI, DIRECTOR
DEPARTMENT OF DESIGN AND CONSTRUCTION

SUBJECT: DRAFT SUPPLEMENTAL ENVIRONMENTAL IMPACT STATEMENT (DSEIS)
FOR WAIMANALO WASTEWATER FACILITIES PLAN
KOOLAUPOKO, OAHU, HAWAII
TMK: 4-1

Thank you for reviewing the subject document and for your correspondence of August 13, 1998. We acknowledge that the Planning Department has no comments to offer at this time to supplement the previously submitted comments on the preliminary draft document. We appreciate your review of the preliminary document that was submitted to your department to facilitate coordination with the Koolaupoko Development Plan revisions. Thank you very much for documenting your previous comments and our responses for the record in your letter.

Based on the latest completion schedule for the Koolaupoko Development Plan provided by your department, the revisions described below will be made on the final supplemental environmental impact statement. The page numbers indicated below are those of the DSEIS and the proposed revisions are italicized.

- 1) Pages S-4 and S-1: "The recommended sizing of treatment facilities is potentially subject to reevaluation during the engineering design phase due to revisions to the Koolaupoko Development Plan. *The public review draft of the revised Koolaupoko Development Plan is expected to be completed by December 1998 and the final revised plan is not expected to be effective until mid-1999 or later.*"
- 2) Page 4-10: "Since draft development strategies for the Koolaupoko DP is scheduled to be completed by December 1998, the Waimanalo Wastewater Facilities Plan was not able to fully consider the proposed revisions to the DP plan."

Mr. Patrick T. Onishi
October 15, 1998
Page 2

A copy of your letter and this response will be included in the final supplemental environmental impact statement. If there are any questions, please feel free to contact our project engineer, Mr. Carl Arakaki at 523-4671. Thank you very much for your time and consideration on this project.

cc: Office of Environmental Quality Control
/ Roy Abe, Hawaii Pacific Engineers



STATE OF HAWAII
DEPARTMENT OF ACCOUNTING AND GENERAL SERVICES
P.O. BOX 1111, HONOLULU, HAWAII 96810

RODOLPH A. CATTANO
COMPTROLLER

LETTER NO (E) 1572.8

SEP 9 1998

Hawaii Pacific Engineers, Inc.
1132 Bishop Street, Suite 1003
Honolulu, Hawaii 96813-2830

Gentlemen:

Subject: Supplemental Waimanalo Wastewater
Facilities Plan, Koolauopoko, Oahu, Hawaii
Draft Supplemental EIS

Thank you for the opportunity to review the subject document.
The proposed project will have no impact on our facilities.
Therefore, we have no comments to offer.

If there are any questions, please have your staff contact
Mr. Ralph Yukumoto of the Planning Branch at 586-0488.

Sincerely,

GORDON MATSUOKA
Public Works Administrator

RY:jj
c: Mr. Carl Arakaki, C&C of Honolulu, Dept. of Design & Const.
OEQC

DEPARTMENT OF DESIGN AND CONSTRUCTION
CITY AND COUNTY OF HONOLULU
650 SOUTH KING STREET, 2ND FLOOR
HONOLULU, HAWAII 96819
PHONE: (808) 523-5004 • FAX: (808) 523-4587



JOSEPH HARRIS
MAYOR

RANDALL K. FUJIKI, AIA
DIRECTOR
ROLAND D. LIBBY, JR., AIA
DEPUTY DIRECTOR

DCP 98-338

October 15, 1998

Mr. Gordon Matsuoaka, Public Works Administrator
Department of Accounting and General Services
P.O. Box 119
Honolulu, Hawaii 96810

Dear Mr. Matsuoaka:

Subject: Draft Supplemental Environmental Impact Statement (DSEIS)
for Waimanalo Wastewater Facilities Plan
Koolauopoko, Oahu, Hawaii
TMK: 4-1

Thank you for reviewing the subject document and for your correspondence of September 9, 1998. We acknowledge that the Department of Accounting and General Services has no comments to offer at this time.

A copy of your letter and this response will be included in the final supplemental environmental impact statement. If there are any questions, please feel free to contact our project engineer, Mr. Carl Arakaki at 523-4671. Thank you very much for your time and consideration on this project.

Sincerely,

RANDALL K. FUJIKI
Director

cc: Office of Environmental Quality Control
Roy Abe, Hawaii Pacific Engineers

BENJAMIN J. CANTRELL
GOVERNOR



STATE OF HAWAII
DEPARTMENT OF BUSINESS, ECONOMIC DEVELOPMENT & TOURISM
HOUSING AND COMMUNITY DEVELOPMENT CORPORATION OF HAWAII
677 QUEEN STREET, SUITE 300
HONOLULU, HAWAII 96813
PAL (808) 547-0800

DONALD K.W. LAU
EXECUTIVE DIRECTOR

SHARTEL M. WAIKAMANO
EXECUTIVE ASSISTANT

98:PEO/803

RECEIVED
AUG 31 1998
HAWAII PACIFIC
ENGINEERS INC.

August 26, 1998

Mr. Carl Arakaki
Department of Design and Construction
City and County of Honolulu
650 South King Street
Honolulu, Hawaii 96813

Dear Mr. Arakaki:

Re: Draft Supplemental Environmental Impact Statement for the Waimanalo
Wastewater Facilities Plan

Thank you for the opportunity to review the subject draft SEIS.

We have no housing related comments to offer at this time.

Sincerely,

Donald K.W. Lau
Donald K.W. Lau
Executive Director

c: OEQC
Roy Abe, Hawaii Pacific Engineers, Inc.

DEPARTMENT OF DESIGN AND CONSTRUCTION
CITY AND COUNTY OF HONOLULU
650 SOUTH KING STREET, 2ND FLOOR
HONOLULU, HAWAII 96813
PHONE: (808) 523-4564 • FAX: (808) 523-4567



RANDALL K. FUJIKI
DIRECTOR

ROLAND D. LIBBY, JR., AIA
DEPUTY DIRECTOR

DCP 98-339

October 15, 1998

Donald K.W. Lau, Executive Director
Housing and Community Development Corporation of Hawaii
Department of Business, Economic Development & Tourism
677 Queen Street, Suite 300
Honolulu, Hawaii 96813

Dear Mr. Lau:

Subject: Draft Supplemental Environmental Impact Statement (DSEIS)
for Waimanalo Wastewater Facilities Plan
Koolauopoko, Oahu, Hawaii
IMK: 4-1

Thank you for reviewing the subject document and for your correspondence of August 26, 1998. We acknowledge that the Housing and Community Development Corporation of Hawaii has no comments to offer at this time.

A copy of your letter and this response will be included in the final supplemental environmental impact statement. If there are any questions, please feel free to contact our project engineer, Mr. Carl Arakaki at 523-4671. Thank you very much for your time and consideration on this project.

Sincerely,

Randall K. Fujiki
RANDALL K. FUJIKI
Director

cc: Office of Environmental Quality Control
Roy Abe, Hawaii Pacific Engineers



**DEPARTMENT OF BUSINESS,
ECONOMIC DEVELOPMENT & TOURISM**

OFFICE OF PLANNING
235 South Beretania Street, 6th Fl., Honolulu, Hawaii 96813
Mailing Address: P.O. Box 2359, Honolulu, Hawaii 96804

Ref. No. P-7694

September 16, 1998

Tel: (808) 587-2846
Fax: (808) 597-2824

RECEIVED
SEP 24 1998

BENJAMIN J. CAYTEANO
GOVERNOR
JERRY HARRIS
MAYOR
BRADLEY J. MOSSMAN
DIRECTOR
HAWAII PACIFIC
ENGINEERS INC.
DEPUTY DIRECTOR
DIRECTOR, OFFICE OF PLANNING

Mr. Randall Fujiki
Director
Department of Design and Construction
City and County of Honolulu
650 South King Street
Honolulu, Hawaii 96813

Attention: Carl Arakaki

Dear Mr. Fujiki:

Subject: Draft Supplemental Environmental Impact Statement (DSEIS) for Waimanalo
Wastewater Facilities Plan, Oahu

We are not opposed to the proposed wastewater facilities plan. Our interest is assurance that the project is designed and carried out in compliance with the Coastal Zone Management (CZM) objectives and policies as required by Chapter 205A, Hawaii Revised Statutes.

If there are any questions, please contact Charles Carole of our CZM Program at 587-2804.

Sincerely,

Bradley J. Mossman
Director
Office of Planning

cc: Gary Gill, OEQC
Roy Abe, Hawaii Pacific Engineers, Inc.
Seiji F. Naya, DBEDT

**DEPARTMENT OF DESIGN AND CONSTRUCTION
CITY AND COUNTY OF HONOLULU**

650 SOUTH KING STREET, 2ND FLOOR
HONOLULU, HAWAII 96813
PHONE: (808) 523-1554 • FAX: (808) 523-1557



JERRY HARRIS
MAYOR

RANDALL K. FUJIKI, AIA
DIRECTOR
ROLAND D. LIBBY, JR., AIA
DEPUTY DIRECTOR

DCP 98-340

October 15, 1998

Mr. Bradley J. Mossman, Director
State Department of Business, Economic Development & Tourism
Office of Planning
P.O. Box 2359
Honolulu, Hawaii 96804

Dear Mr. Mossman:

Subject: Draft Supplemental Environmental Impact Statement (DSEIS)
for Waimanalo Wastewater Facilities Plan
Koolauapoko, Oahu, Hawaii
IMK: 4-1

Thank you for reviewing the subject document and for your correspondence of September 16 1998. We would like to assure you that we will make every effort to comply with the Coastal Zone Management (CZM) objectives and policies of Chapter 205A, HRS.

A copy of your letter and this response will be included in the final supplemental environmental impact statement. If there are any questions, please feel free to contact our project engineer, Mr. Carl Arakaki at 523-4671. Thank you very much for your time and consideration on this project.

Sincerely,

RANDALL K. FUJIKI
Director

cc: Office of Environmental Quality Control
Roy Abe, Hawaii Pacific Engineers



STATE OF HAWAII
 DEPARTMENT OF LAND AND NATURAL RESOURCES
 LAND DIVISION
 P.O. BOX 621
 HONOLULU, HAWAII 96809

AGRICULTURE DEVELOPMENT
 PROGRAMS
 AIR QUALITY
 PLANNING AND CONTROL
 CONSTRUCTION AND
 REVENUE IMPROVEMENT
 CONSERVATION
 MARINE RESOURCES
 LAND DIVISION
 STATE PLANS
 WATER RESOURCE MANAGEMENT

September 10, 1998

LD-NAV
 REF.: 2DSEIS.RCM

Mr. Roy K. Abe, Vice President
 Hawaii Pacific Engineers, Inc.
 1132 Bishop Street, Suite 1003
 Honolulu, Hawaii 96813-2830

Dear Mr. Abe:

SUBJECT: Review : Draft Supplemental Environmental
 Impact Assessment
 Applicant: Department of Wastewater Management, City
 And County of Honolulu
 Proposal : Waimanalo Wastewater Facilities Plan
 Location : Waimanalo, Island of Oahu, Hawaii
 TMK : 1st/ 4-1 Various Parcels

Thank you for the opportunity to review and comment on the
 subject Draft Supplemental Environmental Impact Assessment for the
 proposed project.

The Department of Land and Natural Resources has no comments
 to offer on the subject matter at this time.

Should you have any questions, please contact Nicholas Vaccaro
 of our Land Division's Support Services Branch at 587-0438.

Very truly yours,

Dean Y. Uchida
 DEAN Y. UCHIDA
 Administrator

c: Oahu Land Board Member
 Oahu District Land Office

DEPARTMENT OF DESIGN AND CONSTRUCTION
 CITY AND COUNTY OF HONOLULU
 650 SOUTH KING STREET, 2ND FLOOR
 HONOLULU, HAWAII 96813
 PHONE: (808) 523-1554 • FAX: (808) 523-4587



JEREMY HARRIS
 MAYOR

RANDALL K. FUJIKI, AIA
 DIRECTOR
 ROLAND O. LIBBY, JR., AIA
 DEPUTY DIRECTOR

October 15, 1998

DCP 98-341

Mr. Dean Y. Uchida, Administrator
 Department of Land & Natural Resources, Land Division
 P.O. Box 621
 Honolulu, Hawaii 96809

Dear Mr. Uchida:

Subject: Draft Supplemental Environmental Impact Statement (DSEIS)
 for Waimanalo Wastewater Facilities Plan
 Koolauloko, Oahu, Hawaii
 TMK: 4-1

Thank you for reviewing the subject document and for your correspondence of September 10
 1998. We acknowledge that the Land Division of the Department of Land and Natural
 Resources has no comments to offer at this time.

A copy of your letter and this response will be included in the final supplemental environmental
 impact statement. If there are any questions, please feel free to contact our project engineer,
 Mr. Carl Arakaki at 523-4671. Thank you very much for your time and consideration on this
 project.

Sincerely,

Randall K. Fujiki
 RANDALL K. FUJIKI
 Director

cc: Office of Environmental Quality Control
 Roy Abe, Hawaii Pacific Engineers

BENJAMIN J. CATYANO
GOVERNOR OF HAWAII

RECEIVED
AUG 31 1998



HAWAII PACIFIC
ENGINEERS INC.

STATE OF HAWAII

DEPARTMENT OF LAND AND NATURAL RESOURCES

STATE HISTORIC PRESERVATION DIVISION
33 SOUTH KING STREET, 8TH FLOOR
HONOLULU, HAWAII 96813

MICHAEL D. WILSON, CHAIRPERSON
BOARD OF LAND AND NATURAL RESOURCES

DEPUTY
DEPUTY COLLEEN A. GILMAN

AGRICULTURE DEVELOPMENT
PROGRAM

AQUATIC RESOURCES
CONSERVATION AND

ENVIRONMENTAL AFFAIRS
CONSERVATION AND

RESOURCES DEVELOPMENT
CONTRACTS

MINISTRY AND WILDLIFE
HISTORIC PRESERVATION

LAND MANAGEMENT
STATISTICS

WATER AND LAND DEVELOPMENT

August 24, 1998

Roy K. Abe, Vice President
Hawaii Pacific Engineers, Inc.
1132 Bishop Street, Suite 1003
Honolulu, Hawaii 96813-2830

LOG NO: 22121 ✓
DOC NO: 9808EJ14

Dear Mr. Abe:

SUBJECT: Chapter 6E-8 Historic Preservation Review -- Supplemental Environmental
Impact Statement Preparation Notice (EISP/N) for Waimanalo Wastewater
Facilities Plan
Waimanalo, Ko'olaupoko, O'ahu
TMK: 4-1

Thank you for the opportunity to review the Draft Supplemental Environmental Impact Statement
(DSEIS) for the Waimanalo Wastewater Facilities.

The proposed upgrade and expansion of wastewater facilities at the Waimanalo plant include:

- 1) sewer rehabilitation work on the western portion of the existing sewer system; 2) sewerage of approximately 350 existing homes in the coastal "beach lots" area (Section 2 Improvement District) to eliminate individual wastewater systems; 3) upgrade the Kalaikai Stream Wastewater Pump Station; and 4) make extensive improvements to the Waimanalo Wastewater Treatment Plant.

The DEIS correctly summarizes the known historic sites which have been listed on the Hawaii or National Register of Historic Places. However, additional sites, not listed on the Hawaii or National Register are known to exist in the project area especially in areas on the seaward (makai) side of Kamehameha Highway. Current archaeological work in the Bellows Air Force Station area is providing additional information on Hawaiian prehistory and history. To date, these studies have clearly shown the existence of extensive if discontinuous cultural deposits underlying the Jaucous beach sand.

We believe that the proposed rehabilitation of the existing sewer lines and the proposed upgrades to the Kalaikai Stream Wastewater Pump Station and to the Waimanalo Wastewater Treatment plants will have "no effect" on historic sites. These are existing facilities where historic sites are not known to exist and where historic sites were not recorded during development activities related to the installation of these facilities.

Mr. Abe
Page 2

However, we are concerned about the potential for unknown human burials and other cultural deposits being disturbed during collection system improvements in the proposed "future areas to be sewerred" especially along Bellows AFS and in the Waimanalo beach lots area (Waimanalo Sewers, Section 2 Improvement District). As noted above, the underlying sediments of Jaucous beach sand in these areas are known to contain human burials and other cultural deposits associated with traditional Hawaiian use of the area. Such disturbance would constitute an "adverse effect" on significant historic sites.

Thus, to counter any inadvertent adverse effect on significant historic sites, we request that a written archeological monitoring plan be submitted to this office for review and acceptance prior to the monitoring project. An archeological monitoring plan must contain the following eight specifications:

- 1) The kinds of remains that are anticipated; 2) Where in the construction area the remains are likely to be found; 3) How the expected types of remains will be treated, if found; 4) The archaeologist conducting the monitoring has the authority to halt construction in the immediate area of a find in order to carry out the plan; 5) A coordination meeting between the archaeologist and construction crew is scheduled, so that the construction team is aware of the plan; 6) What laboratory work will be done on remains that are collected; 7) A schedule for report preparation; and 8) Details concerning the archiving of any collections that are made.

If an acceptable archeological monitoring plan is implemented, then we believe that the proposed upgrade and expansion of the Waimanalo Wastewater Facilities will have "no adverse effect" on significant historic sites which may be in the project areas.

If you have any questions please call Elaine Jourdane at 587-0015.

Aloha,

Dana Hibbard, Administrator
State Historic Preservation Division

EJ:jc

DEPARTMENT OF DESIGN AND CONSTRUCTION
CITY AND COUNTY OF HONOLULU
650 SOUTH KING STREET, 2ND FLOOR
HONOLULU, HAWAII 96813
PHONE: (808) 522-4504 • FAX: (808) 523-4507



RANDALL K. FURUKI, AIA
DIRECTOR
ROLAND D. LIBBY, JR., AIA
DEPUTY DIRECTOR

DCP 98-342

October 15, 1998

Dr. Don Hibbard, Administrator
Department of Land & Natural Resources
State Historic Preservation Division
33 South King Street, 6th Floor
Honolulu, Hawaii 96813

Dr. Don Hibbard
October 15, 1998
Page 2

these are existing facilities where historic sites are not known to exist and where historic sites were not recorded during development activities related to the installation of these facilities.

The SHPD indicated a concern regarding the potential for unknown human burials and other cultural deposits being disturbed during collection system improvements in the proposed future areas to be sewer, especially along Bellows Air Force Station and the Waimanalo beach lot area (Waimanalo Sewers, Section 2 Improvement District). It was noted that the underlying sediments of Jaucas beach sand in these areas are known to contain human burials and other cultural deposits associated with traditional Hawaiian use of the area. Such disturbance would constitute an "adverse effect" on significant historic sites.

To counter any inadvertent adverse effect on significant historic sites, SHPD has requested that a written archeological monitoring plan be submitted for review and acceptance prior to the monitoring project. The SHPD indicated that the archeological monitoring plan would be required to contain the following specifications:

- The kinds of remains that are anticipated;
- Where in the construction area the remains are likely to be found;
- How the expected types of remains will be treated, if found;
- The archaeologist conducting the monitoring has the authority to halt construction in the immediate area of a find in order to carry out the plan;
- A coordination meeting between the archaeologist and construction crew is scheduled, so that the construction team is aware of the plan;
- What laboratory work will be done on remains that are collected;
- A schedule for report preparation; and
- Details concerning the archiving of any collection that are made.

If an acceptable monitoring plan is implemented, SHPD indicated that they believe that the proposed upgrade and expansion of the Waimanalo wastewater facilities will have "no adverse effect" on significant historic sites which may be in the project areas."

We would like to note that the sewerage of Hawaii Army National Guard Facility and Department of Hawaiian Homes subdivision projects are not included in the scope of this DSEIS and will require a separate assessment for environmental impacts.

JEREMY HARRIS
MAYOR

Dear Dr. Hibbard:

Subject: Draft Supplemental Environmental Impact Statement (DSEIS)
for Waimanalo Wastewater Facilities Plan
Koolauapoko, Oahu, Hawaii
TMK: 4-1

Thank you for reviewing the subject document and for your correspondence of August 24, 1998. Based on your comments, the revisions described below will be made on the final supplemental environmental impact statement. The page numbers indicated below are those of the DSEIS.

- 1) Page 3-84, new paragraph at the end of the "Historic Sites and Archeological Resources" section:
"Comments on the Draft Supplemental Environmental Impact Statement (DSEIS) were submitted by the State Historic Preservation Division (SHPD) (see correspondence in Chapter 10). The SHPD indicated that additional historic sites not listed on the Hawaii or National Register of Historic Places are known to exist in the project area, especially in areas seaward (makai) of Kalaniana'ole Highway. It was further indicated that current work in the Bellows Air Force Station area is providing additional information on Hawaiian prehistory and history. To date, these studies have clearly shown the existence of extensive if discontinuous cultural deposits underlying the Jaucas sand."
- 2) Page 5-32, new paragraph at the end of the "Archeological and Historic Sites Impacts" section:
"Comments on the Draft Supplemental Environmental Impact Statement (DSEIS) were submitted by the State Historic Preservation Division (SHPD) (see correspondence in Chapter 10). The SHPD indicated that the proposed rehabilitation of existing sewer lines and proposed upgrades to the Kahawai Stream Wastewater Pump Station and Waimanalo Wastewater Treatment Plant will have "no effect" on historic sites. It was indicated that

Dr. Don Hibbard
October 15, 1998
Page 3

We hope that we have adequately addressed your concerns. A copy of your letter and this response will be included in the final supplemental environmental impact statement. If there are any questions, please feel free to contact our project engineer, Mr. Carl Arakaki at 523-4671. Thank you very much for your time and consideration on this project.

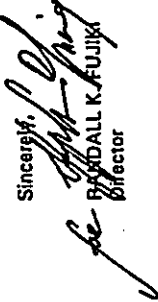
Sincerely,

RANDALL K. FUJIKI
Director

cc: Office of Environmental Quality Control
Roy Abe, Hawaii Pacific Engineers

BEULAH J. CAYetano
GOVERNOR

RECEIVED
SEP 14 1998
HAWAII PACIFIC
ENGINEERS INC.

KAZU HAYASHIDA
DIRECTOR
DEPUTY DIRECTORS
GUYAN K. USUKAWA
OLENA H. OROGOTTO



STATE OF HAWAII
DEPARTMENT OF TRANSPORTATION
869 PUNCHBOWL STREET
HONOLULU, HAWAII 96813-5097

BY REPLY REFER TO:
STP 8.8800

September 9, 1998

Mr. Randall K. Fujiki
Director
Department of Design and Construction
City and County of Honolulu
650 South King Street
Honolulu, Hawaii 96813

Attention: Mr. Carl Arakaki

Dear Mr. Fujiki:

Subject: Draft Supplementary Environmental Impact Statement (EIS)
Waimanalo Wastewater Facilities Plan
Koolauapoko, Oahu, Hawaii

Thank you for your letter of August 5, 1998, requesting our review of the subject Draft Supplementary EIS.

Kalaniana'ole Highway, within the boundaries of the subject project, is a State roadway. The Oahu Regional Transportation Plan identifies improvements to this highway, i.e., widening and/or realignment. To minimize the impact on future improvement costs, the planning and design phases of this project should be coordinated with our Highways Division. Construction for work within the State's right-of-way are also required to be submitted and approved by the Highways Division.

We appreciate the opportunity to provide comments.

Very truly yours,

Kazu Hayashida

KAZU HAYASHIDA
Director of Transportation

cc: Mr. Gary Gill, OEQC
Mr. Roy Abe, Hawaii Pacific Engineers, Inc.

DEPARTMENT OF DESIGN AND CONSTRUCTION
CITY AND COUNTY OF HONOLULU

650 SOUTH KING STREET, 2ND FLOOR
HONOLULU, HAWAII 96813
PHONE: (808) 522-4364 * FAX: (808) 523-4587



JEREMY HARRIS
MAYOR

RANDALL K. FUJIKI, AIA
DIRECTOR
ROLAND D. LIBBY, JR., AIA
DEPUTY DIRECTOR

DCP 98-343

October 15, 1998

Mr. Kazu Hayashida, Director
State of Hawaii
Department of Transportation
869 Punchbowl Street
Honolulu, HI 96813

Dear Mr. Hayashida:

Subject: Draft Supplementary Environmental Impact Statement (DSEIS)
for Waimanalo Wastewater Facilities Plan
Koolauapoko, Oahu, Hawaii
TMK: 4-1

Thank you for reviewing the subject document and for your correspondence of September 9, 1998. We would like to take this opportunity to respond to your comments.

We will coordinate future planning and design work affecting Kalaniana'ole Highway with your Highways Division to the extent possible to minimize the impact on future highway improvement costs. Due to funding constraints and other factors, however, the implementation time frame for the projects involving construction of the new sewers and force main lines within the State's highway right-of-way is uncertain at the present time. Construction plans for work within the right-of-way will be submitted to the Highways Division for review and approval.

A copy of your letter and this response will be included in the final supplemental environmental impact statement. If there are any questions, please feel free to contact our project engineer, Mr. Carl Arakaki at 523-4671. Thank you very much for your time and consideration on this project.

Sincerely,

Randall K. Fujiki
RANDALL K. FUJIKI
Director

cc: Office of Environmental Quality Control
Roy Abe, Hawaii Pacific Engineers

BENJAMIN J. CAYETANO
DIRECTOR



RECEIVED

SEP 23 1998
HAWAII PACIFIC
ENGINEERS INC.

CJAY DELL
DIRECTOR

STATE OF HAWAII
OFFICE OF ENVIRONMENTAL QUALITY CONTROL

325 SOUTH BENTLEY STREET
SUITE 702
HONOLULU, HAWAII 96813
TELEPHONE (808) 586-4185
FACSIMILE (808) 586-4186

September 22, 1998

Randall Fujiki
Department of Wastewater Management
650 South King Street
Honolulu, Hawaii 96813
Attention: Carl Arakaki

Dear Mr. Fujiki,

Subject: Draft Environmental Impact Statement (EIS) for the Waimanalo Wastewater
Facilities Plan

We have the following comments to offer.

1. Impacts on the project: In the impacts section of the final EIS include a discussion of natural and human environmental impacts on this project. Examples of natural impacts include those from soil slippage, hurricanes, tsunami, earthquakes, and volcanic hazards; and human environmental impacts, including population shifts or increases, and increasing or decreasing urbanization.
2. Mitigation measures: In the summary section of the final EIS include a brief description of mitigation measures for long-term impacts.
3. Alternatives:
 - > In this section impacts were evaluated according to financial and technical factors. Please also evaluate them according to other social impacts, such as nuisance factors (noise, odors, dust); visual impacts; archeological, historical and cultural resources; and recreational factors.
 - > In the comparative cost-benefit analysis, consideration was given only to financial and technical factors. "Costs" are any effects that are considered liabilities. The general term for the resultant exclusion of other activities or facilities that comes with implementation of a project is termed "opportunity costs." In the comparative analysis include other costs, such as visual degradation, loss of recreational areas, and social and cultural impacts.

Randall Fujiki
September 22, 1998
Page 2

4. Signature page: Include a statement on the signature page that the final EIS was prepared under the signatory's direction.

If you have any questions please call Nancy Heinrich at 586-4185.

Sincerely,

Roy Abe
Director

c: Roy Abe, Hawaii Pacific Engineers

DEPARTMENT OF DESIGN AND CONSTRUCTION
CITY AND COUNTY OF HONOLULU
650 SOUTH KING STREET, 2ND FLOOR
HONOLULU, HAWAII 96813
PHONE: (808) 532-4561 • FAX: (808) 532-4567



JANEY HARRIS
MAYOR

RANDALL K. FUJIKI, AIA
DIRECTOR
ROLAND D. LIBBY, JR., AIA
DEPUTY DIRECTOR

DCP 98-396

November 30, 1998

Mr. Gary Gill, Director
Office of Environmental Quality Control
235 S. Beretania St., Room 702
Honolulu, HI 96813

Dear Mr. Gill:

Subject: Draft Supplemental Environmental Impact Statement (DSEIS)
for Waimanalo Wastewater Facilities Plan
Koolaupoko, Oahu, Hawaii
IMK: 4-1

Thank you for reviewing the subject document and for your correspondence of September 22, 1998. We would like to take this opportunity to address your comments. Our responses are presented below by subject areas in the order discussed in your letter. The page numbers indicated below are those of the DSEIS and the proposed revisions are italicized.

Impacts on the Project

In response to your comment, discussions of natural and human environmental impacts will be included in the final SEIS. The following revisions will be made:

- 1) Page 5-31, following the second paragraph:

"The Waimanalo WWTP and Kahawai WWPS are located outside the tsunami evacuation zone (GTE Hawaiian Tel, 1998) and is not expected to be impacted directly by tsunamis. Sewers located in the Beach Lot area seaward of Kalaniana'ole Highway that are in the tsunami evacuation zone are not likely to be damaged since they are located below ground. Minor temporary increases in infiltration and inflow of salt water into the sewer system may result from flooding by the tsunami waves. As noted in Chapter 3, inundation along the Waimanalo coastline during major tsunamis in 1946, 1952 and 1960 only ranged between six and nine feet above the mean lower-low water (MLLW) level due to protection offered by the wide, shallow reefs. Major inundation of the Beach Lot area is unlikely since the sewers would be located in areas where the ground is higher than ten feet above MLLW."

Mr. Gary Gill
Page 2
November 30, 1998

Natural and Human Environmental Impacts on the Project

The project is not expected to be significantly impacted by various natural environmental hazards. Flooding impacts generated as a result of hurricanes, tsunamis and extreme storm conditions would be of greatest concern. Impacts associated with flooding were addressed in the discussions above. Impacts from other natural hazards such as high hurricane winds and earthquakes would be mitigated by designing the structures to meet all applicable building codes. Geotechnical investigation of subsurface conditions will allow proper design of foundations to minimize potential adverse impacts stemming from seismic hazards and other causes of unstable soils. The project is not located in an area where volcanic action and landslides are a significant concern.

The project may also be potentially affected by human environmental factors such as changes in population and the degree of urbanization. Significant adverse impacts are not expected if the rate of population growth or extent of urbanization is higher or lower than that originally projected for this project. If population growth and urbanization occurs at a higher rate than projected, the wastewater facilities would simply be required to be expanded at an earlier date in the future. Moratoriums on new projects and sewer connections can be avoided by proper planning and monitoring of the area's growth. This will provide sufficient lead time to secure funding and implement the necessary design and construction activities. Conversely, a lag in population growth and urbanization will allow future expansion of the wastewater facilities to be delayed. Increases in the level of urbanization of Waimanalo would not be expected to have major impacts on the project provided that the land uses in the immediate vicinity of the Waimanalo WWTP remain compatible with the plant operations. The installation of odor control facilities, as discussed earlier in the chapter, may be implemented if odors became an issue due to changes in the surrounding land use."

Mitigation Measures

In response to your comment, a brief discussion of mitigation measures for long-term impacts will be included in the summary section and additional text will be included in applicable sections of Chapter 5. The following revisions will be made:

- 1) Page S-3, before the paragraph on Best Management Practices under "Proposed Mitigation Measures":

"Potential concerns with the increased nitrogen loading on groundwater and nearshore coastal waters due to increased subsurface injection of treated effluent will be mitigated by the use of a nitrogen removal process at the Waimanalo WWTP. Financial impacts will be partly mitigated by distribution of the City's portion of the costs among the large number of wastewater system customers on Oahu. Low interest loans and recovery of costs from users of the reclaimed water will also help mitigate financial impacts. Some of the adverse impacts associated with the growth of Waimanalo's population can be mitigated by timely planning and implementation of other supporting infrastructure improvements. Appropriate planning and design of new developments to help maintain the rural agricultural characteristics of Waimanalo should be utilized to the extent

Mr. Gary Gill
Page 3
November 30, 1998

possible. Energy consumption impacts will be mitigated by the use of energy efficient motors and process design."

2) Page 5-23, end of paragraph at top of page:

"... rural agricultural nature of Waimanalo. Some of the adverse impacts associated with the growth of Waimanalo's population can be mitigated by timely planning and implementation of other supporting infrastructure improvements. Appropriate planning and design of new developments to help maintain the rural agricultural characteristics of Waimanalo should be utilized to the extent possible."

3) Page 5-2B, end of second paragraph:

"... of chlorine. Energy consumption impacts will be mitigated by the use of energy efficient motors and process design."

Alternatives

In response to your comments, the following revisions will be made to also address social impacts and "opportunity costs":

1) Page 2-1, first paragraph, third sentence:

"The various alternatives were evaluated based on cost-effectiveness analyses that considered both monetary and non-monetary factors. In this chapter, the term "cost" was generally used to refer to monetary costs. Where applicable, engineering life-cycle cost analyses were based on a discount rate of 6 percent over a 20 year period."

In the comparative cost-benefit analyses presented in this chapter, it should be noted that there are also other "costs" that typically include any effects that are considered liabilities. "Opportunity costs" is the term used for the resultant exclusion of other activities or facilities that comes with implementation of a project. Examples of other "costs" include visual degradation, loss of recreational resources, and social and cultural impacts."

2) Tables 2-1 through Table 2-4

Refer to the attached copies of the revised tables.

Signature Page

The signature block will be revised as follows:

Mr. Gary Gill
Page 4
November 30, 1998

This document has been prepared under my direction pursuant to the requirements of Chapter 343, HRS:

Randall K. Fujiki, Director

Date

A copy of your letter and this response will be included in the final supplemental environmental impact statement. If there are any questions, please feel free to contact our project engineer, Mr. Carl Arakaki at 523-4671. Thank you very much for your time and consideration on this project.

Sincerely,

RANDALL K. FUJIKI
Director

cc: Roy Abe, Hawaii Pacific Engineers

TABLE 2-1
COMPARISON SUMMARY OF CAPACITY REMEDIATION ALTERNATIVES
(continued)

Implementation Timeframe	1 - No Action Alternative	2 - Perform Sewer Rehabilitation	3 - Increase System Capacity
	Not applicable - No actions are proposed.	One to four years - Implementation timeframe depends on number, type and location of sewer deficiencies. Engineering study required prior to design and construction. Extent of sewer rehabilitation may be significant.	Three to five or more years - Project will require major design effort, securing of funds, and preparation of environmental permit documents. Wastewater pump station and treatment plant upgrade required.

Note: 1. Present worth is based on 20 year life, 6 percent discount rate and no salvage value. Annual unit costs shown are based on 1.1 mgd average flow and 2,420 households.

TABLE 2-1
COMPARISON SUMMARY OF CAPACITY REMEDIATION ALTERNATIVES

	1 - No Action Alternative	2 - Perform Sewer Rehabilitation	3 - Increase System Capacity
Costs ¹	<p>Capital: \$0</p> <p>Annual maintenance: \$245,000</p> <p>Present worth: \$2,810,000</p> <p>Annualized cost: \$255,000</p> <p>Annualized cost per Kgal average flow: \$0.61</p> <p>Annualized cost per household: \$101</p>	<p>Capital: \$650,000</p> <p>Annual maintenance: \$205,000</p> <p>Present worth: \$3,000,000</p> <p>Annualized cost: \$280,000</p> <p>Annualized cost per Kgal average flow: \$0.65</p> <p>Annualized cost per household: \$108</p>	<p>Capital: \$6,080,000</p> <p>Annual maintenance: \$221,000</p> <p>Present worth: \$8,610,000</p> <p>Annualized cost: \$751,000</p> <p>Annualized cost per Kgal average flow: \$1.87</p> <p>Annualized cost per household: \$310</p>
Performance and Reliability	<p>Good - Will not resolve capacity concerns and periodic spills from excess WWTW may occur. Sewer surcharging and exfiltration will also remain a concern. Potential for DOH fines, litigation, and adverse publicity.</p> <p>May result in sewer connection moratorium and prevent construction of proposed new developments.</p>	<p>Excellent - Will be capable of resolving capacity problems provided that rehabilitation work is well planned and properly performed to correct defects.</p>	<p>Excellent - Will be capable of resolving capacity problems.</p>
Public Health and Water Quality Protection	<p>Good - Periodic wastewater spills and exfiltration may result in public health hazards and contribute to water quality degradation, particularly during wet weather, when the effects of such impacts may be of greatest concern. Beach closures may be required following a wastewater spill.</p>	<p>Excellent - Will be capable of resolving concerns with wastewater spills and exfiltration. Reduces public health hazards within recreational waters and minimizes potential need for beach closures.</p>	<p>Excellent - Will be capable of resolving concerns with wastewater spills and exfiltration. Reduces public health hazards within recreational waters and minimizes potential need for beach closures.</p>
Construction and Social Impacts	<p>None - No major construction work is required. No nuisance impacts (noise, odor, dust); visual degradation; impacts to archeological, historical and cultural resources; and other social impacts related to construction.</p>	<p>Moderate to High - Impacts depend on number, type and location of sewer deficiencies. Significant potential impacts such as noise and dust to residential areas and private property. Short-term visual impacts during construction. Generally limited potential impacts to archeological and cultural impacts due to construction primarily in areas with existing utility lines.</p>	<p>Very High - Construction will occur along a major thoroughfare. Excavation area will be large due to depth of sewer. Dust, noise and traffic congestion will be significant. Significant short-term visual impacts during construction. Some potential impacts to archeological and cultural impacts due to construction in new areas without existing utility lines.</p>

**TABLE 2-2
COMPARISON SUMMARY OF INDIVIDUAL WASTEWATER SYSTEM
AND CENTRALIZED WASTEWATER COLLECTION AND TREATMENT ALTERNATIVES**

Cost ¹	Alternative 4a and 4b - Individual Wastewater Systems		Alternative 5a and 5b - Sewer Improvement Districts	
	Cost per Dwelling (homeowner expenses/cost per dwelling)		Cost per Dwelling (homeowner expenses/cost per dwelling)	
	Typical Average Costs (average of existing/new/modified)	Typical Worst Case Cost (new system)	Alternative 5a - Beach Lot Area (Sewer I.D. 2)	Alternative 5b - Bell St. Area (Sewer I.D. 3 & 5)
	Capital: \$1,830 to \$2,000 Annual Maintenance: \$300 Annualized cost: \$460 to \$470	Capital: \$12,000 Annual Maintenance: \$300 Annualized cost: \$1,350	Capital: \$6,500 Annual Maintenance: \$408 Annualized cost: \$980	Capital: \$6,500 Annual Maintenance: \$408 Annualized cost: \$980
	Total Cost of Alternative		Total Cost of Alternative	
	Alternative 4a - Beach Lot Area (Sewer I.D. 2)	Alternative 4b - Bell Street Area (Sewer 3 & 5)	Alternative 5a - Beach Lot Area (Sewer I.D. 2)	Alternative 5b - Bell St. Area (Sewer I.D. 3 & 5)
	Capital: \$840,000 Annual Maintenance: \$106,000 Annualized cost: \$162,000 Annualized cost/home: \$460	Capital: \$200,000 Annual Maintenance: \$30,000 Annualized cost: \$47,000 Annualized cost/home: \$470	Capital: \$7,160,000 Annual Maintenance: \$110,000 Annualized cost: \$734,000 Annualized cost/home: \$2,100	Capital: \$5,990,000 Annual Maintenance: \$130,000 Annualized cost: \$652,000 Annualized cost/home: \$6,500
Public Health Risk	Probable minimal risk provided that systems are adequately sized and properly maintained. May result in overflow of wastewater during heavy rain and flood conditions which will increase public health risks within recreational waters and may result in beach closures.		Minimal risk with proper design and maintenance. Future improvements should minimize risk of wastewater spills and overflows. Public health risks within recreational waters and the potential for beach closures will be minimized.	
Water Quality	Discharge of nitrates to groundwater and coastal waters is a potential concern and possible cause of algal blooms.		Reduction in nitrate discharge to groundwater and possible associated reduction in occurrence of algal blooms. Reduction in injection well nitrate discharge provided future upgrade to the Waimanalo WWTP includes nitrogen removal processes.	
Homeowner Attention	Requires homeowner attention due to requirement for periodic pumping of sludge for routine maintenance or for overload conditions. Homeowner must be aware of water usage and loading.		No significant attention required other than paying monthly wastewater fees.	
Water Reuse	Some homeowners may be using graywater for irrigation. This unregulated practice, however, may be resulting in some public health risks.		Treated effluent meeting regulatory requirements would be available for irrigation reuse following upgrade of the Waimanalo WWTP.	
Energy Consumption	Very low energy usage as energy primarily only required for hauling and treating sludge.		High energy usage for wastewater pumping and treatment.	
Construction and Social Impacts	Minor short-term nuisance construction impacts (noise, odors, dust) and visual impacts for upgrading individual wastewater systems. Limited potential for adverse archeological, historical, and cultural resources impacts due to limited excavation work.		Substantial short-term nuisance construction impacts (noise, odors, dust) and visual impacts due to new sewer construction. Greater potential for adverse archeological, historical, and cultural resources impacts due to more extensive excavation work.	
Administrative/Regulatory Requirements	Requires considerable regulatory effort by Dept. of Health to ensure systems are properly designed, constructed and operated. Spills and complaints must be investigated and enforcement action may be required.		Additional regulatory burden is minimal since effort already required for existing system and flows.	

Note: 1. Present worth is based on 20 year life, 6 percent discount rate and no salvage value. Annual unit costs shown are based on 350 households for Sewer Improvement Districts No. 2 and 100 households for Sewer Improvement Districts Nos. 3 and 5. See discussion on basis of capital costs for upgrading the individual wastewater systems in Alternatives 4a and 4b.

**TABLE 2-3
COMPARISON SUMMARY OF BIOLOGICAL TREATMENT ALTERNATIVES**

Treatment Alternative	Costs ¹	Performance and Reliability	Operation and Maintenance	Energy Consumption	Land Requirements	Construction/Implementation	Environmental and Social Impacts
Alternative 1 Conventional Activated Sludge	Capital Cost: \$5,830,000 Annual Maintenance Cost: \$330,000 Total Present Worth: \$9,640,000 Annualized Cost: \$841,000 Annualized Cost per Kgal Avg. Flow: \$2.10	Moderate - Generally high quality effluent possible. Subject to periodic bulking problems. Minimal nitrate removal.	Moderate - Bulking problems require operator attention. Requires maintenance of aeration equipment. Wide degree of process control possible (dissolved oxygen control, tankage scheme, etc.)	Good - Energy consumption can be reduced by minimizing nitrification.	Good - Slightly larger than anoxic-aerobic alternative.	Good - No major siting problems anticipated. Work is within treatment plant site boundaries. Some dewatering required for clarifiers.	Moderate - No removal of nitrates. Minimal odor problems. Moderate energy consumption. Limited nuisance impacts (noise, odors, dust) since construction is primarily limited to plant site. No adverse impacts to archeological, historical and cultural resources anticipated.
Alternative 2 Anoxic-Aerobic Activated Sludge	Capital Cost: \$5,680,000 Annual Maintenance Cost: \$367,000 Total Present Worth: \$9,890,000 Annualized Cost: \$862,000 Annualized Cost per Kgal Avg. Flow: \$2.15	Excellent - Excellent (single digit) effluent anticipated. Anoxic selector will eliminate or minimize bulking problems. Nitrate removal possible.	Good - Operation expected to be stable due to lack of bulking problems. Requires maintenance of aeration equipment and internal recycle pump. Wide degree of process control possible (dissolved oxygen control, tankage scheme, etc.)	Good - Anoxic treatment utilizes nitrates in lieu of dissolved oxygen for BOD removal.	Good - Tankage size reduced due to use of existing aeration tanks for anoxic treatment.	Good - No major siting problems anticipated. Work is within treatment plant site boundaries. Some dewatering required for clarifiers.	Moderate - Removes nitrates to improve water quality and facilitate reuse. Minimal odor problems. Moderate energy consumption. Limited nuisance impacts (noise, odors, dust) since construction is primarily limited to plant site. No adverse impacts to archeological, historical and cultural resources anticipated.
Alternative 3 Oxidation Ditch	Capital Cost: \$6,988,000 Annual Maintenance Cost: \$325,000 Total Present Worth: \$10,720,000 Annualized Cost: \$935,000 Annualized Cost per Kgal Avg. Flow: \$2.33	Excellent - Excellent (single digit) effluent anticipated. Anoxic selector will eliminate or minimize bulking problems. Nitrate removal possible.	Good - Operation expected to be stable due to lack of bulking problems and long detention time. Requires maintenance of aeration equipment and mixers. Produces partially stabilized sludge. More stable under varying flows and loads.	Good - Anoxic treatment utilizes nitrates in lieu of dissolved oxygen for BOD removal. Oxygen demand anticipated to be slightly lower than other activated sludge processes.	Satisfactory - Tanks will not fit near existing aeration tanks. Siting of the future oxidation ditch may present difficulties due to site constraints.	Good - No major siting problems anticipated. Work is within treatment plant site boundaries. Some dewatering required for clarifiers.	Moderate - Removes nitrates to improve water quality and facilitate reuse. Minimal odor problems. Higher energy consumption. Limited nuisance impacts (noise, odors, dust) since construction is primarily limited to plant site. No adverse impacts to archeological, historical and cultural resources anticipated.

TABLE 2-3
COMPARISON SUMMARY OF BIOLOGICAL TREATMENT ALTERNATIVES (continued)

Treatment Alternative	Costs ¹	Performance and Reliability	Operation and Maintenance	Energy Consumption	Land Requirements	Construction/Implementation	Environmental and Social Impacts
Alternative 6 Ponds/Wetlands Treatment	Capital Cost: \$20,220,000 Annual Maintenance Cost: \$183,000 Total Present Worth: \$22,320,000 Annualized Cost: \$1,950,000 Annualized Cost per Kgal Avg. Flow: \$4.86	Moderate to Poor - Double digit effluent expected but well within standards. Algae may be a potential problem. Dissolved organics (color) may reduce UV disinfection efficiency.	Good - Minimal process control required. Low skill labor required for hyacinth removal. Requires maintenance of aeration system and additional blowers. No sludge pumping required although requires future removal and handling of sludge.	Very Good - Low energy requirements for aeration. Additional energy required for pumping to and from site.	Poor - Extensive land requirements.	Poor - Major construction at new site is involved. Construction of force mains required along existing highways and streets.	Moderate - Removes nitrates to improve water quality but lower removal than mechanical processes. Potential odor problems. Low energy consumption. <i>Greater nuisance impacts (noise, odors, dust) since construction area is large and will be at a new site and along public right-of-way. Possible adverse impacts to archeological, historical and cultural resources depending on location of treatment site. Creates wildlife habitat.</i>

Note: Present worth is based on 20 year life, 6 percent discount rate and no salvage value. Annual unit costs shown are based on 1.1 mgd average flow.

TABLE 2-4
COMPARISON SUMMARY OF EFFLUENT DISPOSAL ALTERNATIVES

Effluent Disposal Alternative	Costs	Performance and Reliability	Operation and Maintenance	Water Quality and Public Health	Availability of Funding	Energy Consumption	Construction/Implementation	Environmental and Social Impacts
Alternative 1 Injection Wells (1.1 mgd avg. flow)	Capital Cost: \$1,210,000 Annual Maintenance Cost: \$45,000 Total Present Worth: \$1,730,000 Annualized Cost: \$150,000 Annualized Cost per Kgal Avg. Flow: \$0.35 (capital costs include three new wells, piping and instrumentation)	Moderate to Good - Due to clogging problems, capacity can decrease substantially from poor effluent quality. Able to accept poor quality effluent if necessary for short durations without major adverse impacts. Reliability of flow handling capacity can be acceptable with high quality effluent, well capacity monitoring and periodic cleaning.	Moderate - Requires periodic cleaning by backwashing, pumping, sediment baking, air jetting, and other means. In the future, effort required to operate and maintain filters although the filter should reduce well clogging substantially. Existing backwashing equipment requires maintenance. Administrative and effluent monitoring effort required for UIC permit.	Moderate - High quality effluent resulting from improved suspended solids removal and disinfection, and reduction of nitrates should minimize water quality impacts. Subsurface geology minimizes nearshore surfacing of effluent. The probability of spills should be minimal following proposed facility improvements.	Moderate - DUNR will need to seek funding. Funding mechanism would be similar to other plant upgrade work.	Low - Flow to injection wells is by gravity flow. Some energy required for filtration equipment.	Good - No major siting problems anticipated. Work is within treatment plant site boundaries.	Generally Positive - Removal of nitrates minimizes water quality impacts. Low energy consumption. <i>Limited nuisance impacts (noise, odors, dust) since construction is primarily limited to plant site. No adverse impacts to archeological, historical and cultural resources anticipated.</i>
Alternative 2a Irrigation of Farm Lots (0.18 mgd avg. flow)	Capital Cost: \$3,610,000 Annual Maintenance Cost: \$46,000 Total Present Worth: \$3,760,000 Annualized Cost: \$328,000 Annualized Cost per Kgal Avg. Flow: \$4.49 (capital costs include chemical feed equip., UV disinfection unit, pump station, force main, storage reservoir, irrigation pumps, distribution lines)	Low to Moderate - Requires backup/supplemental effluent disposal, particularly during wet weather. Also requires high quality effluent. If effluent does not meet stringent quality requirements, other disposal means must be used.	High - Requires considerable effort for maintenance of filters, disinfection and monitoring equipment, and effluent pumping station. Additional effort required for effluent quality analyses, recordkeeping, and administrative tasks.	High - Reduces discharge of effluent to coastal waters. Nutrients are recycled due to uptake by vegetation. Public health risks anticipated to be minimal due to high effluent quality and extensive monitoring requirements.	Good - Funding from U.S. Dept. of Agriculture and Natural Resources Conservation Service available. Other funding sources include State Dept. of Agriculture, University of Hawaii, and City and County of Honolulu.	High - Energy required for filters, UV disinfection and effluent pumping.	Moderate - No major siting problems anticipated. Requires construction of transmission mains, reservoir and other facilities outside plant boundaries. Time and effort required to secure DOH reuse permits (approval).	Generally Positive - Transforms potential environmental liability to valuable resource. Conserves potable water resources. Recycles nitrogen through vegetation. Fairly high energy consumption. <i>Potential nuisance impacts (noise, odors, dust) since offsite construction involved. No adverse impacts to archeological, historical and cultural resources anticipated.</i>

TABLE 2-4
COMPARISON SUMMARY OF EFFLUENT DISPOSAL ALTERNATIVES (continued)

Effluent Disposal Alternative	Costs	Performance and Reliability	Operation and Maintenance	Water Quality and Public Health	Availability of Funding	Energy Consumption	Construction/Implementation	Environmental and Social Impacts
Alternative 2b Irrigation of Oloana Golf Links (0.13 mgd avg. flow)	Capital Cost: \$3,250,000 Annual Maintenance Cost: \$29,000 Total Present Worth: \$3,580,000 Annualized Cost: \$312,000 Annualized Cost per Kgal Avg. Flow: \$6.58 (capital costs include chemical feed equip., UV disinfection unit, pump station, force main, storage reservoir, irrigation pumps)	Low to Moderate - Requires backup/supplemental effluent disposal, particularly during wet weather. Also requires high quality effluent. If effluent does not meet stringent quality requirements, other disposal means must be used.	High - Requires considerable effort for maintenance of filters, disinfection and monitoring equipment, and effluent pumping station. Additional effort required for effluent quality analyses, recordkeeping, and administrative tasks.	High - Reduces discharge of effluent to coastal waters. Nutrients are recycled due to uptake by vegetation. Public health risks anticipated to be minimal due to high effluent quality and extensive monitoring requirements.	Good - Funding potentially available from Oloana Golf Links, City and County of Honolulu and Board of Water Supply.	High - Energy required for filters, UV disinfection and effluent pumping. Reduces energy for potable water pumping however.	Moderate - No major siting problems anticipated. Anticipated to require construction of transmission mains along Kalaianaele Highway. Time and effort required to secure DOH permits (approval).	Generally Positive - Transforms potential environmental liability to valuable resource. Conserves potable water resources. Recycles nitrogen through vegetation. Fairly high energy consumption. Some construction impacts. <i>Potential nuisance impacts (noise, odors, dust) since offsite construction involved. Some potential impacts to archeological, historical and cultural resources due to pipeline excavation near Bellows AFS.</i>

Note: Present worth is based on 20 year life, 6 percent discount rate and no salvage value. Annual unit costs shown are based on 1.1 mgd average flow.

RECEIVED

OCT 26 1998

HAWAII PACIFIC
ENGINEERS INC.



University of Hawai'i at Mānoa

Environmental Center
A Unit of Water Resources Research Center
Crawford 317 • 2350 Campus Road • Honolulu, Hawaii 96822
Telephone: (808) 956-7361 • Facsimile: (808) 956-3980

September 22, 1998
RE:0380.2

Roy Abe
Hawaii Pacific Engineers, Inc.
1132 Bishop Street, Suite 1003
Honolulu, Hawaii 96813-2830

Dear Mr. Abe:

Draft Supplemental Environmental Impact Statement Waimanalo Wastewater Treatment Plant Waimanalo, Oahu

The City and County of Honolulu Department of Design and Construction is updating the 1984 Waimanalo Wastewater Facility revised EIS. The average daily flow of the treatment plant is expected to increase from 0.6 million gallons per day (mgd) to up to 1.1 mgd in the year 2020 due to additional expansion. The Draft Supplemental Environmental Impact Statement (DSEIS) addresses the increase of the 1984 projected flow of 0.7 mgd for the year 2005.

Major proposed improvements include new secondary biological treatment processes, effluent filtration facilities, effluent disposal injection wells, and sludge thickening facilities. Other proposed improvements include an ultraviolet disinfection system and effluent pumping facilities to allow reclaimed effluent to be used as a source of irrigation water. The total estimated cost for the improvements is estimated to be \$16.1 million.

The project also proposes the sewerage of approximately 350 beach homes in Waimanalo to eliminate cesspool use. Soluble nitrates from the cesspools are a concern upon reaching nearshore coastal waters. Expansion and rehabilitation of the sewer system are estimated to cost an additional \$6.7 million.

This Draft Supplemental EIS was reviewed with the assistance of Roger Babcock,

An Equal Opportunity/Affirmative Action Institution

Roy Abe
10/20/98
Page 2

Civil Engineering; Nancy Glover, Pacific Biomedical Research Center; and Victoria Cullins of the Environmental Center.

While our reviewers note that the document is generally thorough and well written, the DSEIS does not contain sufficient information to assess the effect of the Waimanalo Wastewater Treatment Plant (WVTP) on coastal water quality or to assess the cumulative effect upon the Waimanalo Bay ecosystem.

Wastewater Collection System Alternatives

It is not clear from the material presented exactly how much infiltration and inflow (I/I) occurs during a storm with a 5-year recurrence interval. More importantly, it seems somewhat optimistic that 1,500 feet of sewer could be rehabilitated or replaced at such a low cost (\$450,000) and result in such a large reduction in flow (2 mgd). Typically, I/I is widely distributed, difficult to identify, and nearly impossible to completely eliminate.

Wastewater Service Area Expansion Alternatives

It seems that the alternatives addressed are not all "equal." The recommended alternative is to provide sewers in the beach lot areas only if found to be necessary in recommended future studies. The other main alternative, upgrading and replacing on-site systems, will not achieve the same results as installation of sewers. The criteria used to determine how many systems need to be replaced or repaired (110 of 350) consider systems that are clogged. However, focusing on a minor potential for overflow does not address the wider nitrogen pollution issue. A more robust comparison of alternatives should include the cost of replacing all of the on-site units with nitrogen removal capabilities.

It is clear from both common sense and the study included in Appendix D, that the on-site systems constantly discharge nitrogen into the groundwater of the area. Additionally, the subsurface composition is highly permeable and is unlikely to absorb the nitrogen appreciably, thereby leading to its surfacing in the nearshore area. Impacts on coastal water quality of effluents from both the WVTP and the existing cesspools must be quantified before the expenditure of \$22.8 million dollars on WVTP improvements for the purpose of maintaining high water quality in Waimanalo Bay can be justified. The annual cost of installing sewers is approximately 4.5 to 13 times higher than the cost of remaining on individual wastewater systems. If individual wastewater systems are not resulting in water quality problems and the existing effluent disposal from the WVTP does not cause problems with coastal water quality, we will be spending quite a bit of money without gaining commensurate water quality benefits.

Due to cost and technical considerations, it is unlikely that any recommended future studies will be able to provide definitive answers to the extent and cause of algal

blooms in the area (the \$9,000,000 Malama Bay Study is one example). A more immediate question is whether or not a known source of nutrient pollution into the groundwater of the area should be reduced or eliminated. Although other sources may be important and require curtailment, this does not alter the facts that a) on-site systems pollute the groundwater and b) the State Department of Health goals include elimination of disposal systems that deposit untreated sewage into the environment after the year 2000. Based upon this, the recommendation to provide sewers should be given a higher priority than "moderate to low."

Biological Treatment Alternatives.

It is not clear that the proposed anoxic-aerobic activated sludge will achieve the desired less than 5 mg/L results. It appears that the proposed system will consist of three anoxic tanks in a series followed by 2 parallel aerobic tanks. Denitrification will be achieved by mixed-liquor recycle. This represents a single-sludge, single anoxic/aerobic system. Full-scale systems to remove nitrogen are in place at many locations on the mainland such as Reno, NV, River Oaks, FL, Largo, FL, Palmetto, FL, etc. The experience of these systems is that single-sludge, single anoxic/aerobic systems are only capable of meeting less stringent requirements for effluent total nitrogen of 8 to 12 mg/L. In order to reliably achieve total nitrogen concentrations less than 5 mg/L, either a separate-stage system (typically employing the addition of methanol) or one of the patented dual anoxic/aerobic systems (such as Bardenpho) is generally required. Either of these systems would be considerably more expensive (methanol and/or royalties) and operationally challenging than the proposed alternative. It is suggested that the treatment objectives (page 2-13) be revised from "5 mg/L-N total nitrogen (monthly average)" to 10 mg/L-N total nitrogen (monthly average).

Evaluation of Effluent Disinfection Alternatives.

It appears that the recommendation is to utilize UV disinfection for routine operations and hypochlorite for limited shock chlorination of effluent or emergency disinfection (page 2-25). The recommended use of UV light for routine disinfection is appropriate, however, the intermittent use of hypochlorite will be highly problematic. Intermittent use, by definition, requires storage of enough of the chemical to serve "worst-case" needs. Sodium hypochlorite solutions do not store well, especially in warm weather. The estimated half-life of sodium hypochlorite is dependent upon temperature, mineral content (especially iron), and exposure to sunlight. The half-life of a 10% hypochlorite solution in the dark is approximately 800 days at 59 degrees F, 220 days at 77 degrees F and 3.5 days at 140 degrees F. The half-life is reduced by 3-4 times by exposure to sunlight. Recommended storage facilities are enclosed, air-conditioned buildings without windows, in which no more than a 30 day supply is stored. This may be expensive and impractical for the case at hand. If the chemical is stored in granular form (calcium hypochlorite), then it should last much longer, however, this would require preparation of solutions when needed and may not be appropriate for "emergency" needs.

Because of these issues, the fact that gaseous chlorine can be stored essentially indefinitely, and the fact that gaseous chlorine risks are overblown and can be minimized with effective equipment and safety protocols dictated by the industry and the fire code, it seems that it might not be worth any extra expense to install a hypochlorite system, especially if a gaseous chlorine system is already in place.

Discharge of Wastewater Effluent

The DSEIS mentions that "high nutrient loading and the associated occurrence of algal blooms in Waimanalo's coastal waters appear to be the most significant concern," yet there are no data provided in the draft EIS on the fate of nutrients in the WWTP effluent after injection. The draft EIS states that "the significance of the current mass emission of nitrogen from the WWTP is uncertain" and that "the concentration of nitrogen in wastewater is fairly significant relative to marine water quality standards." The location and characteristics of the discharge of wastewater effluent into receiving waters will influence whether the discharge has an adverse impact or no impact. Presently, the location of the discharge of WWTP wastewater effluent into receiving waters is completely unknown. In fact, the document makes it clear that the necessary information from geologic studies to estimate the location of the discharge is not available. The DSEIS mentions that the older coral and limestone formations in the nearshore regions of Waimanalo Bay may result in the transmission of wastewater effluent into the nearshore waters. Given the lack of information on the location of the wastewater effluent discharge and the stated potential for wastewater effluent to be discharged into nearshore waters, the DSEIS statement that "the adverse impacts of nutrients from the WWTP would appear to be negligible," is unsubstantiated. More information on the location of the discharge of WWTP wastewater effluent into receiving waters is essential to assess the impact of the WWTP on water quality and its cumulative impact on the Waimanalo Bay ecosystem. The comparative economics of sewerage site systems and injection well discharge to nearshore waters. The document should contain and discuss aerial photographs (contact the Environmental Center for available copies at 956-3976) of algal blooms in Waimanalo Bay. These photographs may offer insight into where the algal blooms originate.

In addition to the above concerns, the DSEIS does not contain sufficient information to assess the environmental effect of using reclaimed WWTP effluent for irrigation on water quality or to assess the cumulative effect upon the Waimanalo Bay ecosystem. Groundwater could be contaminated by poor irrigation water management, with a cumulative impact to water quality in Waimanalo Bay. The need for irrigation water is not well documented. A 60 million gallon reservoir was recently constructed in Waimanalo to provide farmers with irrigation water. The cost of this irrigation reservoir was roughly \$30 million dollars. No information is provided as to whether the WWTP effluent to be used for irrigation will reduce the acreage irrigated by the State 60 million gallon irrigation reservoir, and subsequently increase the annualized local costs of the

Roy Abe
10/20/98
page 5

irrigation reservoir project which are borne by local residents in proportion to the user fees paid and income taxes paid. An increase in the annualized local costs of the irrigation reservoir may have an adverse effect to the community. There is also no mention of the effluent generated by the Unisyn biowaste facility that is used for irrigation in Waimanalo. In fact, the lands cited in the WWTP facilities plan for effluent reuse by irrigation are the same lands cited in the Unisyn facilities plan for effluent reuse by irrigation.

Alternatives

The primary objective of the proposed upgrades (DSEIS, p 1-4) is to "[e]nhance coastal water quality and promote protection of public health [sic]". Logically, the most effective means of achieving this goal would be to prevent wastewater nutrients from entering Waimanalo's coastal waters altogether.

However, the document lacks an alternative that achieves the removal of waste water nutrient loading into Waimanalo Bay. The only way to have complete control over the effluent and its ultimate discharge point into coastal waters would be to build a system that terminates in a deep ocean outfall. Why was there no discussion of the alternative of connecting the Waimanalo wastewater collection system with the Kaneohe/Kailua system? It would require replacing the WWTP with a pumping facility and installing some three miles of force main. Given the existing capacity of the Kailua WTP of 28.0 mgd, and a proposed capacity of 85.5 mgd, connection of these two systems would appear to offer long term savings in operating costs, while providing the ancillary benefit of diverting all wastewater nutrient loading from Waimanalo's coastal waters. This alternative would cease discharge into injection wells altogether.

Thank you for the opportunity to comment on the DSEIS.

Sincerely,

John T. Harrison
Environmental Coordinator

cc: OEQC
Roger Fujioka
City and County of Honolulu Department of Design and Construction
Roger Babcock
Nancy Glover
Victoria Cullins

DEPARTMENT OF DESIGN AND CONSTRUCTION
CITY AND COUNTY OF HONOLULU
650 SOUTH KING STREET, 2ND FLOOR
HONOLULU, HAWAII 96813
PHONE: (808) 522-4564 • FAX: (808) 523-1567



JERRY HARRISON
MAYOR

RANDALL K. FUJIOKA, AIA
DIRECTOR
ROLAND D. LIBBY, JR., AIA
DEPUTY DIRECTOR

DCP 98-397

November 3, 1998

Dr. John T. Harrison, Director
University of Hawaii Environmental Center
2550 Campus Road, Crawford 317
Honolulu, Hawaii 96822

Dear Dr. Harrison:

Subject: Draft Supplemental Environmental Impact Statement (DSEIS)
for Waimanalo Wastewater Facilities Plan
Koolaupoko, Oahu, Hawaii
TMK: 4-1

Thank you for reviewing the subject document and for your correspondence of September 22, 1998. We would like to take this opportunity to address your comments. Our responses are presented below by subject matter generally in the order discussed in your letter. In some cases, we made an attempt to address related comments under a common subject heading to avoid replicating responses to similar comments. The page numbers indicated below are those of the DSEIS and the proposed revisions are italicized.

Insufficient Information to Assess the Effect of the Waimanalo Wastewater Treatment Plant (WWTP) on Coastal Water Quality or to Assess the Cumulative Effect Upon the Waimanalo Bay Ecosystem

We fully agree that there is insufficient information to assess the effect of the Waimanalo WWTP on coastal water quality or to assess the cumulative effect upon the Waimanalo Bay ecosystem. This is particularly true with regards to the discharge of nutrients (principally nitrogen) and their impact on promoting algal blooms. As discussed on pages 5-4 through 5-6 of the DSEIS, we feel that bacteriological contaminants in the discharged wastewater do not have significant adverse impacts.

As indicated in your comments, the issue of algal blooms occurring in Waimanalo Bay is a complex one. You stated that "Due to cost and technical considerations, it is unlikely that any recommended future studies will be able to provide definitive answers to the extent and cause of algal blooms in the area (the \$9,000,000 Marmala Bay Study is one example)." In a followup telephone conversation with you, you agreed that the algal bloom study for West Maui was another good example of the complexity of the algal bloom issue.

Wastewater Service Area Expansion Alternatives

We agree with your comment that the alternatives are not all "equal." Each alternative has distinct advantages and disadvantages. In the analysis, we are attempting to address a range of alternatives reflecting differing levels of public health and environmental protection. Due to uncertainties associated with such factors as nutrient impacts and budget constraints, it is prudent to examine alternatives that are not equal with respect to the control of nutrients.

On page 2-10 of the DSEIS, the use of individual wastewater systems with nitrogen removal capabilities is addressed. The discussion indicates that the annualized cost of \$2,400 per dwelling for these systems is lower than the \$6,500 cost for sewerage in the Bell Street area but higher than the \$2,100 cost for sewerage in the Beach Lot area. Our project is primarily concerned with the issue of whether or not to sewer the coastal areas. Our analysis indicated that sewerage in the Beach Lot area would be cost-effective if nitrogen is a concern. The requirement for homeowners to install individual wastewater systems with nutrient removal capability would need to be imposed by the State Department of Health rather than the City.

We would like to comment on your statement that "Impacts on coastal water quality of effluents from both the WWTP and the existing cesspools must be quantified before the expenditure of \$22.8 million on the WWTP improvements for the purpose of maintaining high water quality in Waianalo Bay can be justified." The majority of the \$16.1 million cost of improving the Waianalo WWTP is due to upgrading the existing plant to current industry standards and accommodating future projected population growth. The average daily wastewater flow generated by the Beach Lot area is anticipated to account for approximately 12 percent of the projected 1.1 mgd flow of the plant. The majority of the plant improvements will be required regardless of whether the Beach Lot area is sewered. The cost of providing additional plant capacity for the Beach Lot area flow is estimated to be on the order of \$1.1 million. The most significant cost of servicing this area with sewers is the construction cost of the sewers (\$5.8 million).

We agree with your comment that "If individual wastewater systems are not resulting in water quality problems and the existing effluent disposal from the WWTP does not cause problems with coastal water quality, we will be spending quite a bit of money without gaining commensurate water quality benefits." This is the reason that we propose that additional studies be conducted to assess the impact of nutrients from the discharges. We do not agree that a known source of nutrient pollution such as the individual wastewater systems in the Beach Lot area be reduced or eliminated simply because it is known. We feel that Waianalo is a somewhat special case with regard to nutrient pollution. The large population of livestock, the extensive use of land for diversified agriculture, and the processing of biowastes may be resulting in the significant generation of nutrients. The sandy soil substrate in the coastal areas of Waianalo, with the exception of nitrogen removal, appears to provide excellent low-cost treatment of the wastewater. Based on water quality data presented in Chapter 3 and the responses to our resident survey (see Chapter 10), the algal blooms appear to be associated with runoff from the streams. Based on your comments, however, we will upgrade the recommendation to provide sewers from a priority of "moderate to low" to "moderate" in Table 1-2 on page 1-16.

Based on available information, the DSEIS on pages 5-6 through 5-9 discusses the reasons we feel that the nutrients from the Waianalo WWTP injection wells under the proposed action will not have a major impact on Waianalo Bay. On page 5-8, we suggest possible future investigations that may at least provide better insight on the causes of the algal bloom problems in Waianalo. Due to budget limitations, the City does not have sufficient funds to pursue these studies at the present time. The City, however, has provided the Kailua Bay Advisory Council (KBAC) with funds for water quality studies. Since Waianalo Bay is included in the geographical area covered by KBAC, we feel that a portion of these funds should be used to fund the proposed studies.

Wastewater Collection System Alternatives

As indicated on page A-1 of Appendix A, the projected amount of infiltration during peak flow is 3.0 million gallons per day (mgd). To clarify the discussion on infiltration and inflow, the following revisions will be made:

- 1) Page 2-2, fourth paragraph, last sentence: "The rehabilitation work is expected to reduce the WWI/I by at least 2.0 million gallons per day (mgd) (from 5.0 mgd to 3.0 mgd) during a storm with a five-year recurrence interval."
- 2) Page 3-64, first paragraph, last sentence: "The proposed rehabilitation of sewers is projected to reduce future inflow of rainwater into the sewer system by approximately 2.0 mgd (from 5.0 mgd to 3.0 mgd) for a storm with a 5-year recurrence interval."
- 3) Page A-1, Table A-1:

"Peak Flow, mgd (5-year storm)	4.8
Wet weather infiltration/inflow, mgd	3.0"

We agree with your comment that typically infiltration and inflow (I/I) is widely distributed, difficult to identify, and nearly impossible to completely eliminate. In the case of the Waianalo system, however, most of the I/I appears to be due to heavy inflow from a localized area upstream of the Kahawai Wastewater Pump Station (WWPS). This assessment is based on wet-weather flow monitoring records and field observations during a heavy downpour. During actual storm conditions, a high silt-laden flow was observed in one of the branch lines that runs through a heavily vegetated marshy area. Based on I/I studies conducted by another consultant for the City, the "R" factor (percentage of precipitation volume entering the sewer system) was 16 percent for the service area upstream of the Kahawai WWPS. The estimated 50 percent reduction of I/I from 4.0 mgd to 2.0 mgd for this portion of the service area would reduce the "R" factor to eight percent. This is a conservative assumption since an eight percent "R" factor is still significantly higher than the one to three percent "R" factors of typical sewers on Oahu. The I/I problems in Waianalo are discussed in detail in the Waianalo Facilities Plan report.

Dr. John Harrison
Page 4
November 3, 1998

Biological Treatment Alternatives

As a result of your comment and a review of our proposed treatment scheme, we concluded that a 5 mg/L-N total nitrogen effluent concentration would be difficult to achieve on a consistent basis. The 5 mg/L-N effluent concentration objective would be more appropriate to nitrate nitrogen rather than total nitrogen. We concluded that an 8 mg/L-N total nitrogen would be a reasonable "objective" and that a 10 mg/L-N total nitrogen would be a reasonable "standard." In addition to the anoxic-aerobic process itself, we feel that some additional denitrification will take place within the mixed liquor channel downstream of the aeration tanks (by limiting the aeration for mixing), and also within the secondary clarifiers and effluent filters. We plan to provide a mixed liquor channel with a fairly large volume due to the need to maintain low head losses between process units. Creating an anoxic zone in the mixed liquor channel would be similar to providing the additional anoxic stage that is used in the Bardenpho process. It is our understanding that the patent for the Bardenpho process has expired and the payment of royalties is no longer required. Although the volume of methanol that would need to be added would be small, we agree with you that methanol addition to achieve added nitrogen removal would not be desirable. As a result of your comments and our reassessment of the proposed process, the following revisions will be made:

1) Page 2-13, second paragraph:

"* Effluent quality of less than 8 mg/L-N total nitrogen (monthly average)"

2) Page 2-32, second paragraph, first bullet, second sentence:

"Approximately 15 lbs/day will be discharged based on an approximate total nitrogen concentration of 8 mg/L and 0.23 mgd flow ..."

3) Page 5-8, third paragraph, fourth sentence:

"The upgraded treatment facilities is expected to produce effluent with total nitrogen concentrations generally less than 8 mg/L-N. At a 1.1 mgd average flow and 8 mg/L-N total nitrogen concentration, the mass emission of nitrogen would be approximately 73 lbs/day. The amount of nitrogen discharged by the plant will be only slightly higher than current levels despite substantially increased flow. The 8 mg/L nitrogen concentration may in some cases be actually lower than the concentration of the existing groundwater being discharged into Waimanalo Bay."

Evaluation of Effluent Disinfection Alternatives

We discussed your concerns on the use of sodium hypochlorite with Mr. Ivan Hawkins, the Windward Operations District Processing Supervisor of the City's Department of Environmental Services. Mr. Hawkins indicated that a sodium hypochlorite system was recently placed on-line at the Waimanalo WWTP and appears to be operating without problems. The sodium hypochlorite, which is approximately 12 percent in concentration, is stored in 500-gallon black thermoplastic containers to minimize exposure to sunlight. He indicated that although the room in which the hypochlorite is stored is not air conditioned, it has adequate ventilation to

Dr. John Harrison
Page 5
November 3, 1998

keep the room cool. Mr. Hawkins indicated that approximately 200 to 250 gallons of sodium hypochlorite will typically be kept on hand to accommodate routine and emergency needs. On a monthly basis, the unused chlorine solution will be used to "shock" the injection wells and a fresh supply of chlorine solution will be brought in. The storage problems with sodium hypochlorite mentioned in your comments are therefore not anticipated to be a major concern.

Mr. Hawkins further noted that the City has been converting to hypochlorite systems because the new fire code and other applicable industry safety requirements are virtually impossible to meet. It was indicated that training and certifying the required number of workers for gaseous chlorine systems, in particular, is both difficult and very costly.

Discharge of Wastewater Effluent

We are unable to provide a definitive assessment on the fate of nutrients in the Waimanalo WWTP effluent after injection largely due to a lack of geological information beyond the shoreline. On page 5-8, the DSEIS does suggest methods that may be used to help assess the impact of the effluent discharges. In response to your comments, the following revisions will be made:

1) Page 5-8, first paragraph:

"In the case of Waimanalo, the adverse impacts of nutrients from the Waimanalo WWTP may or may not be significant. Based on Waimanalo's geology, it is anticipated that most of the effluent would enter the ocean beyond the shallow bathing waters and coral reef zone where excessive nutrients are of most concern. The general locations of significant discharges of wastewater effluent into coastal waters and any associated potential adverse impact to the ecosystem should be evaluated in further detail through additional investigations."

2) Page 5-8, third paragraph, first sentence:

"Despite the unknown impact of nutrients from the Waimanalo WWTP, the capability to remove nitrogen is proposed for the future plant expansion."

Unfortunately, the Environmental Center was not able to provide us with the aerial photographs discussed in your comments in time to be addressed in this response letter. Please call us as soon as the photographs are available as we agree with you that the photographs may offer insight as to where the algal blooms originate. As previously noted, available information that we have obtained to date indicates that the algal blooms may be primarily associated with runoff from the streams.

With regards to the impact of reclaimed water use on ground water quality, the following revisions will be made:

Dr. John Harrison
Page 6
November 3, 1998

1) Page 5-9, new paragraph, following the first complete paragraph:

"The impact of nutrients from the use of reclaimed water on groundwater and coastal water quality is expected to be negligible. Based on the estimated use of 0.31 mgd of reclaimed water having an average total nitrogen concentration of 8 mg/L-N, the total nitrogen loading on the groundwater would be approximately 21 lb/day. Uptake of nitrogen by the irrigated crops or turf and denitrification occurring in the soil would likely reduce the amount of nitrates actually reaching the water table. The Honolulu Board of Water Supply is anticipated to restrict the use of reclaimed water to areas below the "no pass" line to eliminate concerns with contamination of the potable water supply. The acreage of land irrigated with reclaimed water above the "no pass" line, if allowed, would be minimal and the concentration of the applied reclaimed water would be below the potable water Maximum Contaminant Level (MCL) of 10 mg/L-N for nitrates."

2) Page 5-10, third paragraph, last sentence:

"As discussed earlier, effluent reuse is not anticipated to have any adverse impacts to public health or groundwater quality."

We generally expect the use of reclaimed effluent to have positive impacts on both groundwater and coastal water quality from the standpoint of nutrients. Much of the nitrogen that would normally enter the coastal waters would either be removed through the denitrification process at the Waimanalo WWTP, be taken up by the irrigated plants, or undergo denitrification within the soil. Based on available data, it would appear that the groundwater in Waimanalo could already be considered to be contaminated by excessive nitrogen. It would appear that this problem would need to be addressed by not only focussing on domestic wastewater management, but also improved management of agricultural and other activities which are likely to also be contributing to the water quality problems.

We contacted Mr. Paul Matsuo to assist us in responding to your comments regarding the need for irrigation water, cost impacts and water quality concerns. Mr. Matsuo's response is included in the attached letter.

Alternatives to Eliminate Wastewater Nutrients from Waimanalo's Coastal Waters

We agree with your comment that it would be advantageous to prevent wastewater nutrients from entering Waimanalo's coastal waters altogether and agree that discharge into a deep ocean outfall would be an effective way to achieve this. The DSEIS does include a discussion on conveying Waimanalo's wastewater to the Kailua Regional WWTP on pages 2-33 through 2-35. Please note that this alternative would not simply involve connecting the two systems together near the limits of the collection system. Currently, the Waimanalo system is designed to direct flow largely by gravity lines toward the Waimanalo WWTP. The Waimanalo peak wet weather flow is projected to ultimately be on the order of 6 mgd. The Kailua wastewater collection system is already projected to have difficulty in handling its own projected peak flows and therefore would not be able to readily accommodate Waimanalo's peak flow. To accommodate the wet-weather peak flows in the Kailua system alone, extensive work to rehabilitate the sewers for lift control and provide wet-weather detention facilities is being

Dr. John Harrison
Page 7
November 3, 1998

proposed. In addition to cost and capacity issues, other limitations of the Kailua alternative include reduced reliability due to the need for multiple pump stations, odors from septic wastewaters, loss of reclaimed water for irrigation, and likely opposition by Kailua residents.

We hope that the above responses meet with your satisfaction. A copy of your letter and this response will be included in the final supplemental environmental impact statement. If there are any questions, please feel free to contact our project engineer, Mr. Carl Arakaki at 523-4671. Thank you very much for your time and consideration on this project.

Sincerely,

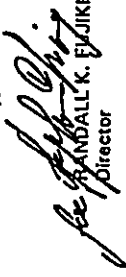

RANDALL K. FUJIKI
Director

cc: Office of Environmental Quality Control
Roy Abe, Hawaii Pacific Engineers

IRRB 343

BENJAMIN J. LAVETANO
Governor



State of Hawaii
DEPARTMENT OF AGRICULTURE
1428 South King Street
Honolulu, Hawaii 96814-2512

JAMES J. MAKAYAMA
Chairperson, Board of Agriculture

LETITIA M. UYEHARA
Deputy to the Chairperson

Mailing Address:
P.O. Box 22159
Honolulu, Hawaii 96822-2159
Fax: (808) 973-9613

RECEIVED

OCT 9 - 1998

HAWAII PACIFIC
ENGINEERS INC.

October 7, 1998

Mr. Roy Abe
Hawaii Pacific Engineers
1132 Bishop Street, Suite 1003
Honolulu, HI 96813-2830

Dear Mr. Abe:

As requested, I am replying to the comments made by the University of Hawaii Environmental Center on the DSEIS.

1. The reuse of effluent from the WTP for irrigation is allowable under the guidelines published by the Department of Health. These guidelines accounted for the environmental effects on bays and estuaries. Further, the effluent will be co-mingled with surplus water from the 60 MG reservoir and applied outside of the aquifer zone. See the attached project map.
2. The need for irrigation is documented in the Waimanalo Watershed Plan and EIS. The reuse is an integral part of the Waimanalo Watershed plan. See the attached excerpts from the plan.
3. The cost of the 60 MG reservoir is not \$30 million, but only \$3,698,828. Under authority of Public Law 83-566, the USDA contributed federal funds of \$799,806, further reducing the State's cost to \$2,899,022. Bids were let and awarded in 1991 with construction completed in 1992.
4. The annualized cost has no relation to local resident user fees or income tax. The entire system is owned and operated by the Waimanalo Irrigation System and the fees are borne by the irrigation water users and not the general community. Any increase in operational costs will be absorbed by the irrigation revenues which are budgeted on an annual basis.



Mr. Roy Abe
Page 2
October 7, 1998

5. Irrigated acreage within the exterior boundary of the Waimanalo Irrigation System was determined when the system was created pursuant to Chapter 167, HRS. The boundary encompasses all the lands to be served by the irrigation system. Whether it be from Unisyn's or WTP's effluent or both is irrelevant because during peak usage there is never enough water.

Regarding Mr. Ryan's comments, I am advised not to respond as the matter is under litigation by Mr. Ryan, and the State of Hawaii has been named a party to this litigation.

If you have any questions, please call me at 973-9473.

Sincerely,

PAUL T. MATSUO, P.E.
Administrator-Chief Engineer
Agricultural Resource Management
Division

Attachments

C: DLNR (C. Santos)
Chairperson, Board of Agriculture

FUNIAL

WATERSHED PLAN
and
ENVIRONMENTAL
IMPACT STATEMENT



WAIMANALO
WATERSHED

CITY AND COUNTY OF
HONOLULU, HAWAII

DECEMBER 1981
U.S. DEPARTMENT OF AGRICULTURE
SOIL CONSERVATION SERVICE

RECOMMENDED PLAN

GENERAL

The recommended plan, Alternative 4, includes features of both the NED plan and the EQ plan. This plan is closely integrated with the State's proposed Waimanalo Agricultural Park Plan and recognizes certain actions by DLNR to acquire long term water rights and upgrade the water collection system in Maunawili Watershed as absolutely essential to the accomplishment of both plans. The P.L. 566 part of the watershed plan is limited to actions within Waimanalo Watershed and includes the following:

Waimanalo Irrigation System (WIS) improvement, sewage effluent irrigation system, solid waste collection sites, land treatment, and technical assistance.

PURPOSE

The purposes of this plan are improvement of agricultural water management through modernizing an antiquated irrigation system; use of treated sewage effluent for irrigation; preserving and enhancing environmental quality by retaining prime and important farmland in agricultural use; protecting and preserving portions of the WIS ditch which are determined to have historic value; and improving health and aesthetics by providing adequate solid waste collection sites.

PLAN ELEMENTS

Waimanalo Irrigation System improvement starts at the east portal of the Aniani Hut Ridge tunnel. Water from Maunawili Watershed, where it is screened, is picked up in a 16-inch pipe. The pipeline carries the water 1.8 miles under gravity pressure to a fenced 60 million gallon, reinforced concrete lined reservoir at the mauka end of Mahailua Street (Plates 1 and 2, Appendix D and Photo 15). Visual treatment will be applied to the reservoir site to minimize adverse visual effects. Flow into the reservoir will be low velocity and discharged to minimize aeration. Releases will be from near the bottom of the reservoir at maximum distance from the irrigation outlet. This arrangement will tend to control plant-parasitic nematodes by reducing the available oxygen. A nematode monitoring facility will be provided. The delivery system below the reservoir will be a closed, pressurized pipe system, 10.9 miles long, ranging from 24 inches to 6 inches in diameter (Table 3B). There will be a metered outlet at each irrigation turnout. At certain critical locations along the upper mainline there will be booster pumps to provide sufficient sprinkler pressure to users with land above the gravity pressure contours.

Treated Sewage Effluent Irrigation System will consist of a separate pump-reservoir-pipeline system 1.4 miles long operated by WIS to use treated sewage effluent to irrigate crops allowed by health regulations, such as bananas, orchard crops, and certain nursery crops. A pump station at the Waimanalo Sewage Treatment Plant will pump the effluent through a 12-inch pipeline to a two-cell 3.0 million gallon effluent storage reservoir to be constructed at

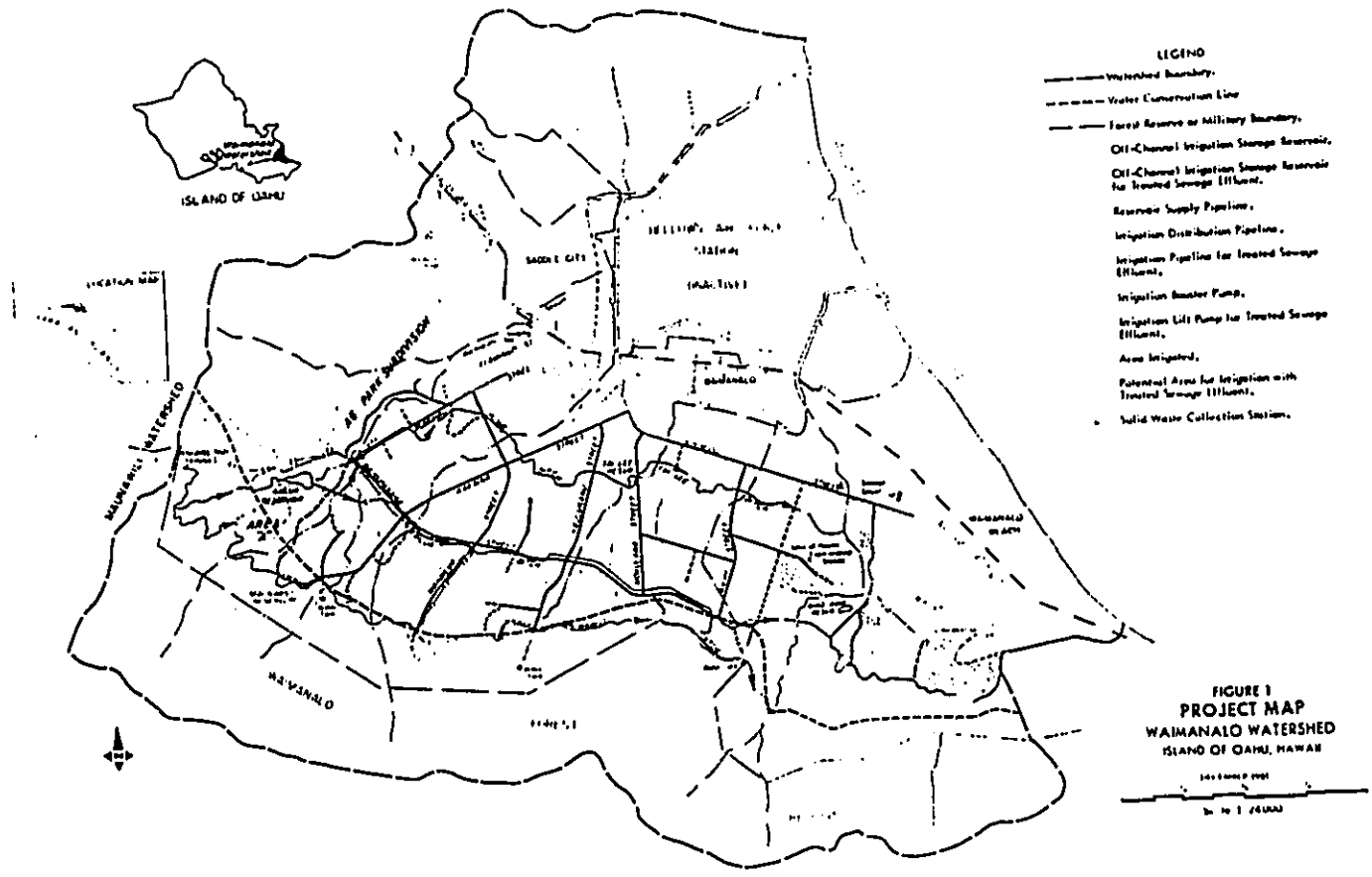

the Wing-King Reservoir site. A relief pump at the reservoir will deliver effluent to lands above the reservoir. All delivery lines will be 12-inch pipe (Plate 4, Appendix D). All effluent will be applied by furrow irrigation on farmlands shown on Figure 1, Appendix E.

Solid Waste Collection Sites will be graded and surfaced to facilitate all weather use and maintenance, and they will be screened from view. The two sites can be equipped with heavy-duty roll-off containers (Plate 5, Appendix D).

The general location of the sites is shown in Figure 1, Appendix E.

Land Treatment includes planning and application of resource management systems by individual farmers to protect the resource base and achieve project benefits. The SCS provides planning and application assistance to farmers through the Windward Oahu Soil and Water Conservation District.

Conservation plans are recorded decisions made by the land users combining the technical information available from the SCS with the farmers' desires and knowledge of the land and crops. Such plans are useful when several related practices are to be applied and the sequence and/or timing are related. Plans are also useful to the farmers in budgeting and scheduling the application of practices and to the SCS in scheduling technical assistance. Conservation practices needed to apply the resource management systems are listed on Table 1.

Land which has not been farmed in the last few years will be cleared.

Surface water removal systems carry rainwater from the land without erosion or damage using such practices as diversions and waterways. Irrigation systems will use the most practical and efficient application methods--sprinklers, drip, and surface systems. Irrigation water management systems are irrigation methods the farmer uses to apply water needed by the crop without waste or erosion and consider such factors as water holding capacity of the soil, moisture requirements of the crop, and rainfall. Soil management systems will assure that the physical condition of the soil does not deteriorate from cultivation, compaction due to traffic, and applying water to supplement natural rainfall. This combination of practices is known as a conservation cropping system.

Technical Assistance is provided through the Windward Oahu Soil and Water Conservation District to farmers in the project area. SCS assistance under the present program is 1.4 person-years per year. It is estimated that 1.7 person-years per year SCS assistance will be needed to assist farmers plan and apply the needed conservation practices during the four-year project installation period. The accelerated technical assistance needed is 0.3 person-year per year over the ongoing program.

P. L. 566 funds for accelerated technical assistance by the University of Hawaii and the Cooperative Extension Service are directed to the control of nematodes by providing onfarm assistance coupled with an intense information program.

Landrights needed for installation of both reservoirs are owned by the State and include 11 acres for the 60 million gallon reservoir and 2.6 acres for the sewage effluent reservoir. Landrights for the pipeline systems are owned by the State or the City and County where pipelines will be in road rights-of-way. Solid waste collection sites will be developed on approximately 0.2 acre of State land.



RECEIVED

OCT 20 1998

HAWAII-PACIFIC ENGINEERS INC.

Our People...Our Islands...In Harmony

October 16, 1998

Mr. Carl Arakaki
Department of Design and Construction
City and County of Honolulu
650 South King Street
Honolulu, Hawaii 96813

DEPARTMENT OF DESIGN AND CONSTRUCTION
CITY AND COUNTY OF HONOLULU
650 SOUTH KING STREET, 2ND FLOOR
HONOLULU, HAWAII 96813
PHONE: (808) 523-1564 • FAX: (808) 523-1567



JEREMY HARRIS
MAYOR

RANDALL K. FUJIKI, AIA
DIRECTOR
ROLAND D. LIBBY, JR., AIA
DEPUTY DIRECTOR

DCP 98-398

October 30, 1998

Mr. Kenneth M. Kaneshiro
United States Department of Agriculture
National Resource Conservation Service
P.O. Box 50004
Honolulu, Hawaii 96850

Dear Mr. Arakaki:

Subject: Draft Environmental Impact Statement (DEIS) - Waimanalo Wastewater Facilities Plan, Waimanalo, Hawaii

We have reviewed the above mentioned document and have no comments to offer at this time.

Thank you for the opportunity to review this document.

Sincerely,

KENNETH M. KANESHIRO
State Conservationist

cc: Governor, State of Hawaii, c/o Office of Environmental Quality Control, 235 South Beretania Street, Suite 702, Honolulu, Hawaii 96813
Mr. Roy Abe, Hawaii Pacific Engineers, Inc., 1132 Bishop Street, Suite 1003, Honolulu, Hawaii 96813-2830

Subject: Draft Supplemental Environmental Impact Statement (DSEIS) for Waimanalo Wastewater Facilities Plan
Koolaulupoko, Oahu, Hawaii
TAMK: 4-1

Thank you for reviewing the subject document and for your correspondence of October 16, 1998. We acknowledge that the U.S. Department of Agriculture has no comments to offer at this time.

A copy of your letter and this response will be included in the final supplemental environmental impact statement. If there are any questions, please feel free to contact our project engineer, Mr. Carl Arakaki at 523-4671. Thank you very much for your time and consideration on this project.

Sincerely,

RANDALL K. FUJIKI
Director

cc: Office of Environmental Quality Control
Roy Abe, Hawaii Pacific Engineers

United States
Department of
Agriculture
Natural
Resources
Conservation
Service
P.O. Box 50004
Honolulu, HI
96850

The Natural Resources Conservation Service works hand-in-hand with the American people to conserve natural resources on private lands.

AN EQUAL OPPORTUNITY EMPLOYER



DEPARTMENT OF THE ARMY
U.S. ARMY ENGINEER DISTRICT, HONOLULU
FORT SHAFTER, HAWAII 96858-5440

ATTENTION

August 14, 1998

HAWAII PACIFIC
ENGINEERS INC.

RECEIVED

AUG 13 1998

DEPARTMENT OF DESIGN AND CONSTRUCTION
CITY AND COUNTY OF HONOLULU
650 SOUTH KING STREET, 2ND FLOOR
HONOLULU, HAWAII 96813
PHONE: (808) 523-4366 • FAX: (808) 523-4567

Civil Works Branch

Mr. Roy K. Abe
Vice President
Hawaii Pacific Engineers, Inc.
1132 Bishop Street, Suite 1003
Honolulu, Hawaii 96813-2830

Dear Mr. Abe:

Thank you for the opportunity to review and comment on the Draft Environmental Impact Statement for the Waimanalo Wastewater Facilities Plan, Koolauopoko, Oahu (TMK 4-1). We do not have any additional comments to offer beyond those previously provided in our letter dated February 26, 1998.

Sincerely,

Paul Mizue, P.E.
Chief, Civil Works Branch

JEREMY HARRIS
MAYOR



RANDALL K. FUJIKI, AIA
DIRECTOR
ROLAND D. ARMY, JR., AIA
DEPUTY DIRECTOR

DCP 98-344

October 15, 1998

Mr. Paul Mizue, P.E., Chief
Civil Works Branch
Department of the Army
U.S. Army Engineer District, Honolulu
Fort Shafter, Hawaii 96858-5440

Dear Mr. Mizue:

Subject: Draft Supplemental Environmental Impact Statement (DSEIS) for Waimanalo Wastewater Facilities Plan
Koolauopoko, Oahu, Hawaii
TMK: 4-1

Thank you for reviewing the subject document and for your correspondence of August 14, 1998. We acknowledge that the U.S. Army District, Honolulu, has no additional comments to offer at this time.

A copy of your letter and this response will be included in the final supplemental environmental impact statement. If there are any questions, please feel free to contact our project engineer, Mr. Carl Arakaki at 523-4671. Thank you very much for your time and consideration on this project.

Sincerely,

RANDALL K. FUJIKI
Director

cc: Office of Environmental Quality Control
Roy Abe, Hawaii Pacific Engineers

98 - DC 373 M



RECEIVED

FISH AND WILDLIFE SERVICE
Pacific Islands Ecoregion
300 Ala Moana Boulevard, Room 3-122
Honolulu, Hawaii 96850

Box 30088

Box 30088

DEPARTMENT OF DESIGN AND CONSTRUCTION
DIVISION OF FACILITIES

Honolulu, Hawaii 96850

In Reply Refer to: 10-10-98

OCT 14 1998

OCT 14 1998

United States Department of the Interior

DSEIS for Waimanalo Wastewater Facilities Plan
Koolaupoko, Oahu, Hawaii

to stream biota (e.g. endemic species such as the Hawaiian prawn or 'Opae 'oeha'a [*Macrobrachium grandimanus*]) and mitigation for these impacts. Without this information, the Service cannot fully comment on the future impacts of this project-related activity to fish and wildlife resources. The Service recommends that this issue be resolved in the FSEIS.

SPECIFIC COMMENTS

Fig. 3-31: Wetlands, Chapter 3. In paragraph two, the DSEIS states that "Secondary areas, where small numbers of birds exist, are of lesser importance." The Service disagrees with this statement and recommends that it be deleted.

Fig. 3-41: Fauna, Terrestrial and Freshwater Biota, Biological Environment, Chapter 3. In paragraph one, the DSEIS includes a description of the four federally listed endangered waterbirds. The Service recommends that the FSEIS include a subsection that fully describes the federally protected terrestrial species that occur in the vicinity of the proposed project area. This new subsection should conform to the format used for describing "Endangered and Protected Species" found in the Marine Biota section (page 3-42).

Fig. 3-41: Fauna, Terrestrial and Freshwater Biota, Biological Environment, Chapter 3. In paragraph two, the DSEIS should include a list of the birds that are protected under the Migratory Bird Treaty Act known to occur along the coastline of Waimanalo Bay. The Service is aware of the following species in the area: the Pacific golden-plover or Kolea (*Pinnipennis*), the ruddy turnstone or 'Akekeke (*Arenaria interpres*), the sanderling or Hunakai (*Calidris alba*), and the wandering tattler or 'Ujili (*Heteroscelus incanus*), and recommends that this information be incorporated in the FSEIS.

Fig. 3-41: Fauna, Terrestrial and Freshwater Biota, Biological Environment, Chapter 3. In paragraph four, the DSEIS does not clearly identify the species collected in Waimanalo Stream. Furthermore, the DSEIS does not reference a survey for the identification of biota found to occur in the Waimanalo Stream. The Service recommends that these species be identified by their scientific names, and whether or not they are endemic to Hawaii. The Service also recommends that the FSEIS include the citation for the survey work conducted in the Waimanalo Stream.

SUMMARY

The Service is concerned that groundwater, stream habitats and freshwater biota may be impacted by the proposed dewatering activities. The Service recommends that all dewatering and discharge activities be further explained. Also, the Service recommends that the FSEIS provide a complete list of species known to occur in the streams that may be impacted by the proposed project. Finally, the Service recommends that the FSEIS provide a detailed description of the potential impacts to and mitigation for groundwater resources, stream habitat, and freshwater species that may be impacted by the proposed dewatering and discharge-related activities.

Dear Mr. Arakaki:

The U.S. Fish and Wildlife Service (Service) has reviewed the Draft Supplemental Environmental Impact Statement (DSEIS) for the above referenced action. The DSEIS was prepared by Hawaii Pacific Engineers, Inc., and the proposing agency is the City and County of Honolulu, Department of Design and Construction. The Service offers the following comments for your consideration.

The purpose of the proposed project is to improve the Waimanalo Wastewater Treatment Plant (WWTP) by increasing its average design capacity from 0.7 million gallons per day (mgd) to 1.1 mgd, reducing the flow of raw water into the wastewater system (thereby, reducing the spillage of untreated sewage from the wastewater collection system during storm events), and decreasing its overall contribution of nitrogen into Waimanalo Bay. Major proposed improvements include a new anoxic-aerobic activated sludge biological secondary treatment process, an effluent filtration system, additional injection wells, new sludge thickening facilities, an upgraded electrical system, and expanded personnel and maintenance facilities. Other proposed improvements that allow production of reclaimed water for irrigation include an ultraviolet disinfection system and effluent pumping facilities.

GENERAL COMMENTS

The Service believes that the DSEIS adequately describes the proposed action and most of the significant fish and wildlife resources located at the proposed project site. The Service believes that the preferred alternative is the action least likely to impact fish and wildlife resources. Most of the potential impacts to fish and wildlife resources anticipated to result from the preferred alternative have been adequately described in the DSEIS.

However, the Service believes that water-quality impacts to groundwater and streams (e.g. Waimanalo, Inoaole, and Multiwaiolena streams) are not sufficiently assessed in the DSEIS. The DSEIS indicates that dewatered effluent may be discharged back into the ground or into streams. The DSEIS does not include: (1) the potential volume or description of the effluent that may be discharged, (2) the manner in which this action would be implemented, and (3) potential impacts

DEPARTMENT OF DESIGN AND CONSTRUCTION
CITY AND COUNTY OF HONOLULU
650 SOUTH KING STREET, 2ND FLOOR
HONOLULU, HAWAII 96813
PHONE: (808) 523-4564 • FAX: (808) 523-4567



MANOALL K. FUKUDA, AIA
DIRECTOR
ROLAND D. LIBBY, JR., AIA
DEPUTY DIRECTOR

JEREMY HARRIS
MAYOR

The Service appreciates the opportunity to provide comments on the proposed project. If you have questions regarding these comments, please contact Fish and Wildlife Biologist Kevin Foster at 808/541-3441 (fax: 808/541-3470).

Sincerely,

Robert P. Smith
Pacific Islands Manager

cc: NMFS-PAO, Honolulu
USEPA-Region IX, Honolulu
DAR-State of Hawaii
CZMP-State of Hawaii
CWB-State of Hawaii
PD-City and County of Honolulu
Wilson Okamoto & Associates, Inc.
EQC-State of Hawaii

December 14, 1998

Mr. Robert P. Smith
Pacific Islands Manager
U.S. Department of the Interior
Fish and Wildlife Service
300 Ala Moana Blvd., Room 3-122
Honolulu, Hawaii 96850

Dear Mr. Smith:

Subject: Draft Supplemental Environmental Impact Statement (DSEIS)
for Waimanalo Wastewater Facilities Plan
Koolaupoko, Oahu, Hawaii
TMK: 4-1

Thank you for reviewing the subject document and for your correspondence of October 14, 1998. We would like to take this opportunity to address your comments. Our responses are presented below by subject areas in the order discussed in your letter. The page numbers indicated below are those of the DSEIS and the proposed revisions are italicized.

General Comments

In response to your comments, discussions on the impacts of the dewatering effluent discharges will be included in the final SEIS. The following revisions will be made:

- 1) Page 5-32, new paragraphs following the first paragraph under "Water Quality Impacts":

"Comments on the DSEIS were submitted by the Fish and Wildlife Service (FWS) of the United States Department of Interior (see correspondence in Chapter 10). The FWS expressed concern on the possible adverse water quality impacts of the dewatering effluent on the groundwater and streams. The discharge volume and quality of the dewatering effluent, however, is presently uncertain as they may vary substantially depending on the site specific soil/groundwater conditions and dewatering practices employed by the contractor.

Due to the lack of drainage facilities and nearby streams, dewatering effluent generated during the construction of sewers in the Section 2 Sewer Improvement District (see

Mr. Robert P. Smith
Page 2
December 17, 1998

Due to the lack of drainage facilities and nearby streams, dewatering effluent generated during the construction of sewers in the Section 2 Sewer Improvement District (see Figure 1-2b and Figure 3-16) is anticipated to be discharged into unbackfilled trenches or recharge pits. Dewatering is expected to be required only for the construction of approximately 1,200 feet of sewer line along Hinalea and Hiliu streets as the remaining sewers are likely to be located above the water table. Sheet piling is anticipated to be used to minimize the volume of dewatering effluent and to prevent caving of the sandy subsoil. No adverse impacts to stream water quality are anticipated. Groundwater pumped from the sewerline trenches will essentially be discharged back into the coastal basal aquifer without addition of any significant contaminants.

Dewatering effluent generated during construction of new treatment process tanks at the Waimanalo WWTTP is anticipated to be disposed of in a nearby grass-lined drainage ditch, recharge pits, or the existing effluent disposal wells. The drainage ditch, which is located along the northern boundary of the adjacent polo field, handles runoff from the plant site and discharges to Inoaole Stream. Inoaole Stream is classified as a non-perennial stream by the Hawaii Stream Assessment study (State of Hawaii Commission on Water Resources Management, 1990).

Water quality data for a groundwater sample obtained for an NPDES permit currently pending approval for the construction of effluent filters at the Waimanalo WWTTP (R.M. Towill, 1998) are as follows:

Total Nitrogen	22,000	µg/l
Ammonia Nitrogen	230	µg/l
Nitrate-Nitrite	21,000	µg/l
Total Kjeldahl Nitrogen	<750	µg/l
Total Phosphorous	730	µg/l
Turbidity	17	NTU
Total Suspended Solids	670	mg/l
pH	7.1	
Dissolved Oxygen	4	mg/l
Temperature	28	°C
Salinity	<1.0	ppi
Oil and Grease	1.2	mg/l
Benzene	<1	µg/l
Cadmium	<5	µg/l
Ethylbenzene	<1	µg/l
Lead	<100	µg/l
Purgeable Hydrocarbons	<50	µg/l

Mr. Robert P. Smith
Page 3
December 17, 1998

Toluene <1 µg/l
Total Xylenes <2 µg/l

The salinity of the groundwater sample, which was less than 1 part per thousand (ppt), is relatively low. The nutrient levels of the groundwater, however, are relatively high and may potentially result in algal blooms in the stream and nearshore coastal waters if dewatering effluent is discharged in significant quantities to the drainage ditch. It should be noted that the groundwater data is based on only one sample obtained from a single test boring hole. The water quality of the groundwater with respect to salinity, nutrient concentration, and other parameters could potentially differ under continuous pumping during actual dewatering operations.

Sheet piling is anticipated to be used to minimize the volume of dewatering effluent required to be pumped and to prevent caving of the sandy subsoil. The anticipated dewatering discharge for the effluent filter project is 200 to 300 gallons per minute (gpm) for 24 hours per day for a duration of up to three months (R.M. Towill, November 1998). Other treatment units to be constructed in the future will likely have similar or possibly slightly higher and/or more prolonged dewatering discharges.

The volume and quality of dewatering effluent that would actually enter Inoaole Stream is uncertain. Inoaole Stream is not perennial and visual observations indicate that there is generally no flow in the stream branch that receives flow from the Waimanalo WWTTP site (see Figure 3-16). Percolation of the dewatering discharge into the ground as it flows along the approximately 2,000 foot long grass-lined ditch should substantially reduce or even eliminate flow to Inoaole Stream. Uptake of nutrients and removal of suspended solids by grass and other vegetation growing in the ditch will minimize potential water quality impacts on Inoaole Stream in the event that the flow reaches the stream. If necessary due to water quality impacts on Inoaole Stream, some or all of the dewatering effluent at the treatment plant site may be disposed of in recharge pits or the existing effluent disposal wells. Groundwater pumped from the excavations will essentially be discharged back into the coastal aquifer without addition of any significant contaminants. The effluent disposal wells should have sufficient capacity to accept the dewatering effluent except during peak wastewater flows that occur during storm conditions. Discharge of the relatively small volume of dewatering effluent to the drainage ditch and Inoaole Stream during storm conditions should have a negligible impact on water quality relative to the stormwater runoff.

2) Pages 11-4 and 11-5, additions to reference list:

"R.M. Towill Corporation, "General Permit DOI Form A, Quality of Discharge, Waimanalo Wastewater Treatment Plant Improvements," August 1, 1997.

Mr. Robert P. Smith
Page 4
December 17, 1998

R.M. Towill Corporation, personal communication with Bert Salto, November 18, 1998.
"State of Hawaii, Commission on Water Resources Management, "Hawaii Stream Assessment: A Preliminary Appraisal of Hawaii's Stream Resources," Report R84, prepared by the National Park Service, Hawaii Cooperative Park Studies Unit, December 1990."

Wetlands

In response to your comment, the sentence "Secondary areas, where small numbers of birds exist, are of lesser importance," in the second paragraph on page 3-31 will be revised to "Secondary areas are areas where a smaller number of birds exist."

Federally Protected Terrestrial Species

In response to your comments, additional discussions to describe federally protected terrestrial species will be included in the final SEIS. We will not be including a separate subsection for this information, however, since the information can be readily integrated under the "Fauna" heading. In following discussions with Mr. Don Palawski of your office, it was indicated that this would be acceptable. The revisions will also include the addition of scientific names and references. The following revisions will be made to the final SEIS:

- 1) Page 3-41, new paragraphs to replace first five paragraphs under "Fauna":

"Based on an inventory of fish and wildlife in Waimanalo, the wetlands at Bellows Air Force Station provide habitat for four endangered endemic waterbird species (Belt Collins Hawaii, 1995a; Bruner, 1994). These waterbirds are the Hawaiian Duck (*Anas wyvilliana*), Hawaiian Coot (*Fulica americana* abai), Hawaiian Gallinule (*Gallinula chloropus sandvicensis*), and Hawaiian Stilt (*Himantopus mexicanus knudseni*).

The endemic Short-eared Owl or Pueo (*Asio flammeus sandvicensis*) has also been observed at the Bellows AFS (Belt Collins Hawaii, 1995a; Bruner, 1994). The Pueo is listed as an endangered species on Oahu by the State of Hawaii Division of Forestry and Wildlife.

In comments to the DSEIS (see Chapter 10), the U.S. Department of Interior Fish and Wildlife Service indicated that the Service is aware of four species of birds protected by the Migratory Bird Treaty Act that are known to occur along the coastline of Waimanalo Bay. These species include the Pacific golden-plover or Kolea (*Pluvialis fulva*), the ruddy turnstone or *p-Akeke* (*Arenaria interpres*), the sanderting or *Hunakai* (*Calidris alba*), and the wandering tattler or *p-Uliti* (*Heterosceclus incanum*).

Mr. Robert P. Smith
Page 5
December 17, 1998

A variety of other introduced bird species has also been observed in Waimanalo Valley, including common mynahs (*Acridotheres tristis*), barred doves (*Coccyzias zosterops*), spotted doves (*Streptopelia chinensis*), Japanese white-eyes (*Zosterops japonicus*), red-crested cardinals (*Parozia coronata*), Yumeg Mannikins (*Lophura punctulata*), red-vented bulbuls (*Pycnonotus cafer*), house sparrows (*Passer domesticus*), and cattle egrets (*Bubulcus ibis*) (Park Engineering, 1982).

Wildlife which typically inhabit the upper watershed region and open agricultural lands include non-endemic feral dogs and cats, mongoose (*Herpestes auropunctatus*), and rats (*Rattus exulans tauviteiensis*) (Park Engineering, 1982). Introduced Jackson chameleons and iguanas are also known to inhabit the area.

Aquatic fauna in Kailua Reservoir and Waimanalo Stream have also been recorded (Park Engineering, 1982). Introduced species such as bullfrogs (*Rana catesbeiana*), tilapia (*Tilapia mossambica*), and mosquito fish (*Gambusia affinis*) have been observed in Kailua Reservoir. The aquatic fauna collected in Waimanalo Stream include the endemic Hawaiian prawn (*Macrobrachium grandimanus*) and goby (*Awaous stamineus*), and the introduced Tahitian prawn (*Macrobrachium lac*), guppy (*Poecilia reticulata*), and green swordtail (*Xiphophorus helleri*) (Park Engineering, 1982; U.S. Fish & Wildlife Service, 1978).

The Nature Conservancy's Hawaii Natural Heritage Program database indicated that two endemic species of damselflies, the Blackhook Hawaiian Damselfly (*Megalagrion ulerohamatum ulerohamatum*) and the Oceanic Megalagrion (*Megalagrion oceanicum*) have been observed near Waimanalo Stream in the vicinity of the Olomana Golf Links (Asquith, 1997). These two species are currently candidates for listing under the Federal Endangered Species Act.

The endemic and endangered Hawaiian Hoary Bat (*Lasiurus cinereus scroptus*) is known to roost solitary in trees and occur in upland forests as well as in coastal habitats. Data on the bat's distribution and behavior are extremely limited (Belt Collins Hawaii, 1995a; Bruner, 1994). This species was not listed in the Nature Conservancy's database or indicated to have been observed in Waimanalo in the references reviewed.

The fish and wildlife habitat in the area is not unique. Most of the fauna found in the area are common introduced species, with the exception of the Hawaiian prawn, goby, damselflies, Pueo, and the endangered water birds."

- 2) Page 11-1, additions to reference list:

"Asquith, A., Biological summary accompanying listing package for five species of Hawaiian Megalagrion damselflies, unpublished document by the U.S. Fish & Wildlife Service, Pacific Islands Office, Honolulu, Hawaii, 1997."

Mr. Robert P. Smith
Page 6
December 17, 1998

"Bruner, Phillip L., *Avifaunal and Feral Mammal Survey of Bellows Air Force Station, Oahu*," prepared for Bell Collins Hawaii, May 1994."

3) Page 11-6, addition to reference list:

"U.S. Fish and Wildlife Service, *Stream Channel Modification in Hawaii. Part A: Statewide Inventory of Streams: Habitat Factors and Associated Biota*," Biological Services Program, April 1978."

Birds Protected Under the Migratory Bird Treaty Act

In response to your comment, a discussion on birds protected by the Migratory Bird Treaty Act will be included in the final SEIS. The new paragraph covering this information is included in the above revisions to the "Fauna" section (page 3-41).

Species in Waimanalo Stream

In response to your comment, additional discussions to clearly identify endemic and non-endemic species of biota in Waimanalo Stream and the applicable references for this information will be included in the final SEIS. The revisions that will be made are reflected above under the revisions to the "Fauna" section (page 3-41).

Please note that Waimanalo and Muiliwaibena streams are not anticipated to be impacted by the discharge of dewatering effluent since they are not located near the areas which will require dewatering activities. As discussed above, Inosole Stream may potentially be impacted by dewatering activities at the Waimanalo WWTP. Inosole Stream is not perennial and no biota surveys were found for this stream.

In closing, we hope that our proposed revisions adequately address your concerns. A copy of your letter and this response will be included in the final supplemental environmental impact statement. If there are any questions, please feel free to contact our project engineer, Mr. Carl Arakaki at 523-4671. Thank you very much for your time and consideration on this project.

Very truly yours,

RANDALL K. FUJIKI
Director

cc: Office of Environmental Quality Control
Roy Abe, Hawaii Pacific Engineers



United States Department of the Interior

U.S. GEOLOGICAL SURVEY
WATER RESOURCES DIVISION
677 Ala Moana Boulevard, Suite 415
Honolulu, Hawaii 96813

August 25, 1998

RECEIVED

AUG 27 1998

HAWAII PACIFIC
ENGINEERS INC.

DEPARTMENT OF DESIGN AND CONSTRUCTION
CITY AND COUNTY OF HONOLULU

650 SOUTH KING STREET, 2ND FLOOR
HONOLULU, HAWAII 96813
PHONE: (808) 523-1564 • FAX: (808) 523-4567



JEREMY HARRIS
MAYOR

RANDALL K. FUJIKI, AIA
DIRECTOR
ROLAND D. LIBBY, JR., AIA
DEPUTY DIRECTOR

DCP 98-345

October 15, 1998

Mr. Carl Arakaki
City and County of Honolulu
Department of Design and Construction
650 South King Street
Honolulu, Hawaii 96813

Mr. William Meyer, District Chief
United States Department of the Interior
U.S. Geological Survey, Water Resources Division
677 Ala Moana Boulevard, Suite 415
Honolulu, Hawaii 96813

Dear Mr. Meyer:

Dear Mr. Abe:

Subject: Draft Supplemental Environmental Impact Statement
for Waimanalo Wastewater Facilities Plan
Koolaupoko, Oahu, Hawaii

Subject: Draft Supplemental Environmental Impact Statement (DSEIS)
for Waimanalo Wastewater Facilities Plan
Koolaupoko, Oahu, Hawaii
TMK: 4-1

The staff of the U.S. Geological Survey, Water Resources Division, Hawaii District, has reviewed the Draft Supplemental Environmental Impact Statement, and we have no comments to offer at this time.

Thank you for allowing us to review the report. We are returning it for your future use.

Thank you for reviewing the subject document and for your correspondence of August 25, 1998. We acknowledge that the U.S. Geological Survey has no comments to offer at this time.

Sincerely,

William Meyer
William Meyer
District Chief

cc: The Honorable Benjamin Cayetano, Governor, State of Hawaii
Mr. Roy Abe, Hawaii Pacific Engineers, Inc.

Enc.

Sincerely,

Randall K. Fujiki
RANDALL K. FUJIKI
Director

cc: Office of Environmental Quality Control
Roy Abe, Hawaii Pacific Engineers



DEPARTMENT OF THE NAVY
 COMMANDER
 NAVAL BASE PEARL HARBOR
 517 RUSSELL AVENUE
 PEARL HARBOR, HAWAII 96860-5020

IN REPLY REFER TO:

5090P.1
 Ser N42(23) 4678
 September 3, 1998

Mr. Carl Arakaki
 Department of Design and Construction
 City and County of Honolulu
 650 South King Street
 Honolulu, HI 96813

Dear Mr. Arakaki:

SUBJECT: DRAFT SUPPLEMENTAL ENVIRONMENTAL IMPACT STATEMENT
 (DSEIS) FOR WAIMANALO WASTEWATER FACILITIES PLAN,
 KOOLAUPOKO, OAHU, HAWAII OF JULY 29, 1998

Thank you for providing us with an opportunity to review and comment on the DSEIS. The Navy's review comments are provided as follows:

- a. On page 3-84, first paragraph, the indented portion containing the criteria has been incorrectly quoted and should be revised and presented exactly as found in 36 CFR 60.4. Also, it should be enclosed in quotation marks. The first "bullet" is not one of the four criteria, which should be identified as Criteria a, b, c, and d, respectively. The word "Facilities" at the head of the second sentence should be replaced with "Properties."
- b. On page 3-84, third paragraph, insert the abbreviation "(IARII)" before "...a subconsultant to the [sic] Belt Collins Hawaii." Delete "the" in line 4. At the end of the paragraph, delete "...is required..." drop the period, and add the following: "...was conducted by IARII and reported in 1998."
- c. On page 4-14, second paragraph, the DSEIS states, "Federal land in Waimanalo primarily consists of the Bellows Air Force Station (AFS), which is administered by the Pacific Division, Naval Facilities Engineering Command." At this time, the Navy has no assets at Bellows AFS. Please revise the sentence to read that the AFS is the property of the 15th Air Base Wing (ABW) at Hickam Air Force Base. The Navy has been granted a permit by the Air Force that allows the Marine Corps to train in designated areas at Bellows AFS.
- d. On page 4-14, fourth paragraph, the DSEIS reads, "Future development plans for the Bellows AFS were developed by Belt Collins Hawaii and documented in the Final Environmental Impact Statement, Land Use and Development Plan Bellows Air Force Station, Waimanalo, Hawaii, (1995). Please revise the sentence to read as follows: "Future development plans for the Bellows AFS were developed for the Commander in Chief, U.S. Pacific Command (USCINCPAC), and documented in the...."

5090P.1
 Ser N42(23) / 4678
 September 3, 1998

The Navy's point of contact is Mr. Clyde Yokota at 474-0439. You may direct all future correspondence on this subject to me at Commander, Naval Base, Pearl Harbor, Attn: N42, 517 Russell Avenue, Pearl Harbor, HI 96860-4884.

Sincerely,

C. K. Yokota
 C. K. YOKOTA
 Environment Program Manager
 By direction of
 Commander, Naval Base,
 Pearl Harbor

Copy to:
 Mr. Roy Abe
 Hawaii Pacific Engineers, Inc.
 1132 Bishop Street, Suite 1003
 Honolulu, HI 96813-2830

Governor
 State of Hawaii
 c/o Office of Environmental Quality Control
 235 South Beretania Street, Suite 702
 Honolulu, HI 96813

DEPARTMENT OF DESIGN AND CONSTRUCTION
CITY AND COUNTY OF HONOLULU

650 SOUTH KING STREET, 2ND FLOOR
HONOLULU, HAWAII 96813
PHONE: (808) 523-1004 • FAX: (808) 523-4507



JORDAN HARRIS
MAYOR

RANDALL K. FUJIKI, AIA
DIRECTOR
ROLAND D. LISKY, JR., AIA
DEPUTY DIRECTOR

DCP 98-346

October 15, 1998

Mr. Clyde Yokota
Environment Program Manager
Department of the Navy
Commander, Naval Base Pearl Harbor
Attn: N42
517 Russell Avenue
Pearl Harbor, HI 96860-5020

Dear Mr. Yokota:

Subject: Draft Supplemental Environmental Impact Statement (DSEIS)
for Waimanalo Wastewater Facilities Plan
Koolaupoko, Oahu, Hawaii
TMK: 4-1

Thank you for reviewing the subject document and for your correspondence of September 3, 1998. Based on your comments, the revisions described below will be made on the final supplemental environmental impact statement. The page numbers indicated below are those of the DSEIS and the proposed revisions are italicized.

1) Page 3-84, first paragraph:

"Properties are considered to be historically significant if:

"The quality of significance in American history, architecture, archeology, engineering, and culture is present in districts, sites, buildings, structures, and objects that possess integrity of location, design, setting, materials, workmanship, feeling and association, and

(a) that are associated with events that have made a significant contribution to the broad patterns of our history; or

(b) that are associated with the lives of persons significant to our past; or

(c) that embody the distinctive characteristics of a type, period, or method of construction, or that represent the work of a master, or that possess high artistic values, or that represent a significant and distinguishable entity whose components may lack individual distinction; or

Mr. Clyde Yokota
October 15, 1998
Page 2

(d) that have yielded, or may be likely to yield, information important in prehistory or history."

2) Page 3-84, third paragraph:

"... The archaeological sites were evaluated by the International Archaeological Research Institute, Inc. (IARI), a subconsultant to Bait Collins Hawaii. ... Further testing on the Bellows Air Force Station archeological sites to determine the actual boundaries was conducted by IARI and reported in 1998."

3) Page 4-14, second paragraph:

"Federal land in Waimanalo primarily consists of the Bellows Air Force Station (AFS). The Bellows AFS is the property of the 15th Air Base Wing (ABW) at Hickam Air Force Base. The Navy has been granted a permit by the Air Force that allows the Marine Corps to train in designated areas at Bellows AFS."

4) Page 4-14, fourth paragraph:

"Future development plans for the Bellows AFS were developed for the Commander in Chief, U.S. Pacific Command (USCINCPAC), and documented in the ..."

A copy of your letter and this response will be included in the final supplemental environmental impact statement. If there are any questions, please feel free to contact our project engineer, Mr. Carl Arakaki at 523-4671. Thank you very much for your time and consideration on this project.

Sincerely,

RANDALL K. FUJIKI
Director

cc: Office of Environmental Quality Control
Roy Abe, Hawaii Pacific Engineers

1988 110

BENJAMIN J. CAVETANG
Governor



State of Hawaii
DEPARTMENT OF AGRICULTURE
1428 South King Street
Honolulu, Hawaii 96814-2512

June 30, 1998

Mr. Roy Abe, P.E.
Hawaii Pacific Engineers
1132 Bishop Street, Suite 1003
Honolulu, HI 96813-2830

Dear Mr. Abe:

This is in response to your faxed memorandum of June 16, 1998 regarding the Waimanalo Wastewater Facilities Plan. The following are our comments to Mr. Joseph M. A. Ryan, Jr.'s June 10th letter:

1. Alternate reservoir site. The reason is twofold: first, the site isn't under our control and second, it will not gravity feed into our distribution system due to elevation differences (means we will need to have two separate pump stations, one to get the sewage effluent, then another to inject under pressure into our distribution pipeline).
2. Energy is a major concern for our system. The reason is not only the power costs, but also the maintenance of electrical equipment due to constant use.
3. Compensation to the existing lessee is not a problem as we have a working agreement on the use of the site in exchange for acceptance of their roof runoff and wash water.
4. Springs that occur will not be affected by our twin cell reservoir as they are in another location, away from the springs.

I would not feel comfortable agreeing that the reservoir is an unresolved issue. This will jeopardize our federal watershed agreement status and may result in the loss of federal assistance.

Thank you for allowing us to provide our views on the matter. If there are any questions, please call me at 973-9473.

Sincerely,

PAUL T. MATSUO, P.E.
Administrator-Chief Engineer
Agricultural Resource Management
Division

C: HBCS
Chairperson, Board of Agriculture
Waimanalo I.S.S.



HILLTOP EQUESTRIAN CENTRE

P.O. Box 447
Waimanalo, Hawaii 96795
(808) 250-8463
Fax: (808) 250-8870

RECEIVED

98 AUG -5 AM 10:40

July 21, 1998, DESIGN & CONSTRUCTION
DIVISION OF
PLANNING & PROGRAMMING

Dr. Kenneth E. Sprague
Director
Department of Environmental Services
650 S. King Street, 3rd Floor
Honolulu, Hawaii 96813

RE: Supplemental Environmental Impact Statement, Waimanalo Wastewater Facilities Plan

Dear Dr. Sprague:

Mr. Paul T. Matsuo's letter of June 30, 1998, contradicts your prior letter of August 21, 1997 stating the City and County of Honolulu will not process water reclaimed by the Unisyn process of anaerobic digestion of food wastes.

Mr. Matsuo claims, in numbered paragraph 3: "... a working agreement on the use of the site in exchange for acceptance of their roof runoff and wash water." Wash water contains food wastes, grease, and other organic matter. Wash water is the water used to wash out garbage trucks, grease trap pumping trucks, and other Unisyn equipment and receiving pit areas where the food wastes are spilled. It does not make sense to process sewage at the Waimanalo STP, pump it uphill, and have it contaminated with food matter before it can be used for irrigation. Even small amounts of grease cause major pipe clogging problems over time.

The adding of Unisyn runoff and wash water to the reservoir also creates a severe liability problem for the City and State. Who will be responsible for the pollution of Inosole Stream from the food wastes when the reservoir overflows during a wet winter?

The City will be depositing the majority of the contents of the reservoir. Unisyn wash water will contaminate all of the contents of the reservoir. During a "wet" winter, Unisyn runoff will add to the reservoir. Unless the City takes back water (now contaminated) into the Waimanalo STP for disposal via injection well, the reservoir will overflow. R-1 effluent cleansed by UV and de-nitrified but contaminated by Unisyn with DOA approval must either be re-processed by the C&C STP or be allowed to overflow into the stream. Distribution to farmers, when rain water is standing in puddles on their farms, is not an option because the effluent will flow to streams from the flooded fields.

Thank you,

Joseph M. A. Ryan Jr.
Owner

Enclosure

DEPARTMENT OF ENVIRONMENTAL SERVICES
- DEPARTMENT OF WASTEWATER-MANAGEMENT
CITY AND COUNTY OF HONOLULU
510 SOUTH KING STREET
HONOLULU, HAWAII 96813



JOHN W. HARRIS
MAYOR

KENNETH E. SPRAGUE, P.E., P.D.
DIRECTOR
CHERYL K. OKUMA-SEPE
DEPUTY DIRECTOR

September 18, 1998

WMC 98-820

Mr. Joseph N.A. Ryan, Jr.
Hilltop Equestrian Centre
P.O. Box 562
Waimanalo, Hawaii 96795

Dear Mr. Ryan:

Subject: Draft Supplemental Environmental Impact Statement
Waimanalo Wastewater Treatment Plant (WWTP)

Thank you for your letter dated September 8, 1998 regarding to the subject project. The City and County of Honolulu is not proposing to construct the two-cell 3.5 million gallons reservoirs. The reservoirs you are referring to are being considered by the State Department of Agriculture (DOA). Please address any concerns you may have regarding to the construction of the reservoirs to the State DOA.

If you have any questions, please contact Ross Tanimoto from the Division of Environmental Quality at 527-6754.

Sincerely,
CHERYL K. OKUMA-SEPE
KENNETH E. SPRAGUE
Director

cc: DDC-DPP (Carl Arakaki)
Corp Counsel (Duane Pang)

HILLTOP EQUESTRIAN CENTRE
P.O. Box 562
Waimanalo, Hawaii 96795
(808) 258-6403
Fax: (808) 258-0870

RECEIVED

SEP 9 - 1998

HAWAII PACIFIC
ENGINEERS INC.

September 8, 1998

Dr. Kenneth E. Sprague
Director
Department of Environmental Services
650 S. King Street, 3rd Floor
Honolulu, Hawaii 96813

RE: Draft Supplemental Environmental Impact Statement, Waimanalo Wastewater Facilities Plan

Dear Dr. Sprague:

I object to the placement of a two-cell 3.5 million gallon reservoir on the Unisyn property when viable alternative sites exist. My multiple objections are as follows:

1) Mr. Paul T. Matsuo's letter of June 30, 1998, states: 1) the "alternate reservoir site" A) is not under state control and B) will not gravity feed into the irrigation system pipeline, 2) Energy costs, 3) Compensation to the existing lessees through a working agreement, and 4) springs will not be affected. Mr. Matsuo goes on to state the federal assistance to be used for the new reservoir.

1. Alternative reservoir site
 - A) The alternative site proposed in my prior letter is TMC 4-1-9-283. The site is vacant land owned by the State of Hawaii. Mr. Matsuo is wrong when he implies the State of Hawaii does not own the site.
 - B) Placement of the two-cell 3.5 million gallon reservoir on the Unisyn leasehold will force the non-irrigation users of Waimanalo to pay the cost of pumping water to the Unisyn leasehold. The Draft EIS does not state how much the DOA is willing to pay for the R-1, de-nitrified water. The cost of pumping water about 100' up hill, 3/4 mile distant will be borne by the entire Waimanalo sewer using community.
2. Energy costs borne by the Department of Agriculture. There will always be energy and maintenance costs for moving water. The DOA, proposing to add Unisyn washdown water to the proposed reservoir, under the working agreement referred to by Mr. Matsuo, will be forced to "clean" irrigation pipes of accumulated grease deposited by Unisyn in the form of washdown water much more often than if pure R-1 water were used. The cost of cleaning is not included in the effluent disposal system analysis.

(Surely you know that "Unisyn wash down water" will contain vegetable and animal grease and oil, petroleum (from truck washing) and can contain the brucella bacteria, Pfiesteria, and other pathogens. Restaurants import beef, shell fish, and other products, any infected item, imported to Hawaii, could be trucked to Unisyn and deposited into the new reservoir for distribution to Waimanalo's farmers ultimately resulting in the de-certification of Hawaii's beef industry (brucellosis) and the poisoning of Hawaii's ocean (Pfiesteria). I urge you to debunk this theory rather than dismiss the theory as alarmist.)

Dr. Kenneth E. Sprague
Page 2
September 8, 1998

3) The "working agreement" to compensate Unisyn as a lessee is a myth. The state has an agricultural protection law in the form of HRS-205 which protects prime agricultural lands and reserves those lands for the production of feed, forage, food, fiber crops and horticultural plants. Unisyn is a garbage processor and subject to HRS-205. Unisyn, being a 21 acre site using an additional 2 acres of DOA pond (the existing Wing King Reservoir) and additional storage for distribution in a solid waste disposal system, is required to obtain a Special Use Permit (SUP) from the state Land Use Commission. Unisyn has never applied for a state SUP. The taking of Unisyn land for the purpose of constructing a new reservoir (when alternative land at TRAK 4-1-9-283 exists) is an outrageous and blatant example of State Executive Officers circumventing existing law and ignoring both the legislature and the community. Unisyn and the State, through this device, commit Environmental Injustice, forcing an undesirable land use on a small community.

4) Mr. Matsuo believes that no fresh water springs will be affected by the construction of a new reservoir on the Unisyn leasehold and that the springs occur in another location. He is wrong. Prior excavation on that site was done. The hole was backfilled because of the volume of fresh clean water that bubbled from the ground. Simple soil research testing will show the site was disturbed. Simple research has shown that the USDA PCRA has determined the Wing King Reservoir (into which Unisyn dumps 20,000 a day of putrid garbage) has a fresh water spring within it. The hydrologic pressure of the ground water during and after "wet" winters will cause either excessive construction costs or failure of the concrete liner during "low" water periods.

The cost of construction will include Federal money. Federal money should not be used to circumvent state law (HRS-205) and permit a private corporation, Unisyn, to operate as an open dump (HRS 342H-1) in violation of permits and laws. This is environmental injustice and is improper. It is wrong that the City and County of Honolulu should be drawn into the continued law violations by offering the assistance of this Draft Environmental assessment.

II. Dr. Sprague, in his letter of August 21, 1997, relates: "It is our understanding that UNISYN does not accept any form of human wastes for processing. . ." belies the current ordinances of the C&C of Honolulu. UNISYN, currently having operated without CUP-2 and SUP for the past three (3) years, under city ordinance is capable of composting the bio-solids of wastewater treatment plants. Unisyn could, and most probably will, accept human waste in the future. Since the new reservoir will accept runoff and washdown water, human excrement residues will enter the new reservoir and be distributed to farmers. The city has created a massive liability question that is not resolved in the DEIS. Who will be responsible for disease transmitted by wastewater reuse additionally contaminated by Unisyn? It is the City and State that have the deep pockets.

Thank you,

Joseph N. A. Ryan Jr.
Joseph N. A. Ryan Jr.
Owner

Enclosure

LRMS 148

BENJAMIN J. CAVETANO
Governor



State of Hawaii
DEPARTMENT OF AGRICULTURE
1428 South King Street
Honolulu, Hawaii 96814-2512

June 30, 1998

Mr. Roy Abe, P.E.
Hawaii Pacific Engineers
1132 Bishop Street, Suite 1003
Honolulu, HI 96813-2830

Dear Mr. Abe:

This is in response to your faxed memorandum of June 16, 1998 regarding the Waimanalo Wastewater Facilities Plan. The following are our comments to Mr. Joseph N. A. Ryan, Jr.'s June 10th letter:

1. Alternate reservoir site. The reason is twofold: first, the site isn't under our control and second, it will not gravity feed into our distribution system due to elevation differences (means we will need to have two separate pump stations, one to get the sewerage effluent, then another to inject under pressure into our distribution pipelines).
2. Energy is a major concern for our system. The reason is not only the power costs, but also the maintenance of electrical equipment due to constant use.
3. Compensation to the existing lessee is not a problem as we have a working agreement on the use of the site in exchange for acceptance of their roof runoff and wash water.
4. Springs that occur will not be affected by our twin cell reservoir as they are in another location, away from the springs.

I would not feel comfortable agreeing that the reservoir is an unresolved issue. This will jeopardize our federal watershed agreement status and may result in the loss of federal assistance.

Thank you for allowing us to provide our views on the matter. If there are any questions, please call me at 973-9473.

Sincerely,

Paul T. Matsuo

PAUL T. MATSUO, P.E.
Administrator-Chief Engineer
Agricultural Resource Management
Division

cc: HRCS
Chairperson, Board of Agriculture
Waimanalo I.S.



DEPARTMENT OF DESIGN AND CONSTRUCTION
CITY AND COUNTY OF HONOLULU
 650 SOUTH KING STREET, 2ND FLOOR
 HONOLULU, HAWAII 96813
 PHONE: (808) 523-4564 • FAX: (808) 523-4567



JEREMY HARRIS
 MAYOR

MARDALL K. FUJIKI, AIA
 DIRECTOR
 ROLAND D. LIBBY, JR., AIA
 DEPUTY DIRECTOR

DCP 98-408

November 6, 1998

Mr. Joseph Ryan, Jr.
 Hilltop Equestrian Centre
 P.O. Box 562
 Waimanalo, Hawaii 96795

Dear Mr. Ryan:

Subject: Draft Supplemental Environmental Impact Statement (DSEIS)
 for Waimanalo Wastewater Facilities Plan
 Koolauopoko, Oahu, Hawaii
 TMK: 4-1

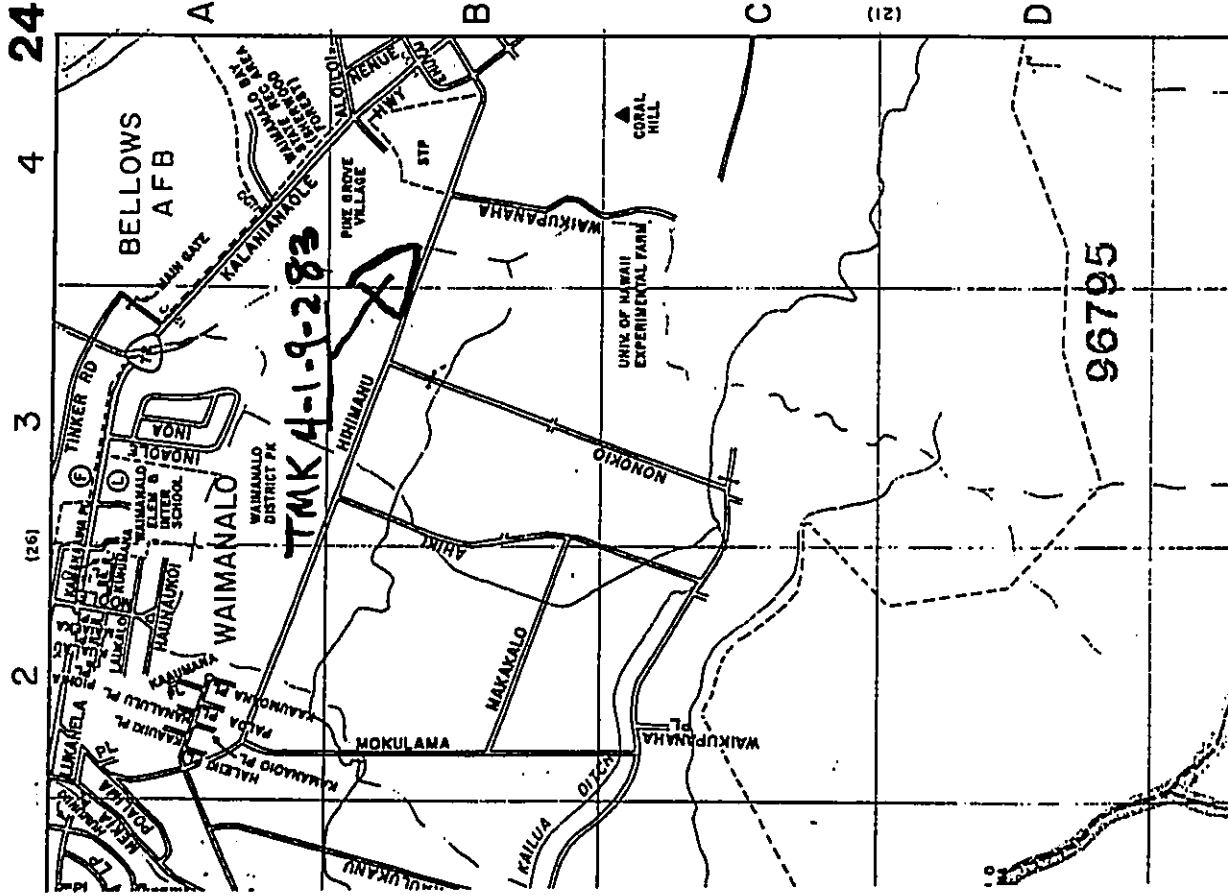

Thank you for reviewing the subject document and for your correspondence of September 8, 1998. Thank you also for your earlier SEIS Preparation Notice followup letter of July 21, 1998 which we received just prior to publishing the DSEIS. Dr. Kenneth Sprague, who currently heads the newly formed City and County of Honolulu Department of Environmental Services (formerly Department of Wastewater Management), responded to your September 8 letter as it was addressed to him. The Waimanalo Wastewater Facilities project, however, is now under the City's new Department of Design and Construction. We would like to take this opportunity to respond to your comments expressed in both letters from our department's viewpoint. We apologize for not responding to your July 21 letter in a timely manner. Our letter of response was not sent to you due to a request by our Corporation Counsel to review the letter prior to it being released. This procedure is the result of the ongoing litigation involving yourself, Unisyn Biowaste Technology, the State, and the City.

We will attempt to address your comments in both the July 21 and September 8 letter by subject matter. We will avoid replicating responses to similar comments included more than once in your letters. Please note that we are not able to fully respond to all of your comments related to the Unisyn discharge and the irrigation reservoir since many of the issues are beyond our jurisdiction. The construction and management of the reservoir will be the responsibility of the State Department of Agriculture (DOA). The DOA has informed us that they are not able to provide input at this time and that all matters on this subject are being referred to the State Attorney General due to the ongoing litigation involving the Unisyn facilities. Also, it is not the intent of the Waimanalo Facilities Plan and this SEIS to assist Unisyn or justify its operations.

Mr. Joseph Ryan
Page 2
November 6, 1998

Processing of Unisyn Washwater

The City and County of Honolulu has no plans to process the Unisyn wash water either before or after it is discharged to the reservoir. We would assume that Unisyn will be responsible for providing necessary processing of their wash water to meet any requirements imposed by the State Department of Health and the DOA.

Overflow of Irrigation Reservoir

We do not anticipate the reservoir to overflow during wet weather since the City intends to use existing and proposed new injection wells at the Waimanalo Wastewater Treatment Plant (WWTP) as a backup/supplemental means of effluent disposal. Discharge of treated effluent from the Waimanalo WWTP to the reservoir would not need to occur when there is no demand for irrigation water such as during the wet season. We assume that the DOA will size and manage the reservoir to maintain sufficient surplus capacity to accommodate both Unisyn's flow and rainwater entering the reservoir. The impacts of any overflow from the reclaimed irrigation reservoir Inoaola Stream may not be significant if the reservoir water quality is properly maintained by regulating the quality of water discharged into the reservoir.

Quality of Irrigation Water

The adequacy of the quality of the irrigation water leaving the reservoir will ultimately be the responsibility of the DOA. The City will be only responsible for ensuring that the quality of the reclaimed water from the Waimanalo WWTP meets all the State Department of Health requirements. The DOA will own the reservoir and be responsible for its operation. The City will have no control over Unisyn's discharge to the reservoir. To our knowledge, there are no plans for Unisyn to accept the City's wastewater treatment plant sludge. If Unisyn were to accept wastewater sludge from City or non-City treatment facilities in the future, stringent CRF 503 requirements discussed in Chapter 2 of the DSEIS would need to be met to ensure public health protection.

You may wish to contact the State Department of Health regarding health risks and treatment requirements associated with the use of reclaimed "non-sewage" wastewater for irrigation. In general, we would expect that the presence of human pathogens that are of a major concern with domestic sewage would be less of concern with Unisyn's wash water since it should not contain human feces. Your concern on the impact of harmful microorganisms from imported food products may justify further investigation. These issues should be addressed in the environmental impact statement currently under preparation for the Unisyn facilities.

Alternate Reservoir Site

Although your suggested alternate reservoir site (TMK: 4-1-9-3-283) is located on State of Hawaii land, Mr. Paul Matsuo's June 30, 1988 letter indicates that it is not under the control of the DOA. While it may be possible to utilize your proposed site for the reservoir by resolving the land ownership/control issues, we agree with Mr. Matsuo's assessment that providing a second pump station would not be cost-effective. To the extent possible, it is

Mr. Joseph Ryan
Page 3
November 6, 1998

much more desirable to rely on simple gravity flow from the reservoir to the various users rather than on additional mechanical and electrical equipment which require constant attention. We acknowledge your concerns regarding the use of prime agricultural land for the Unisyn facilities and the new irrigation reservoir. The reservoir site was selected by the U.S. Department of Agriculture and described and documented in its Watershed Plan and Environmental Impact Statement, Waimanalo Watershed (December 1981).

Allocation of Costs

The cost of pumping water to the irrigation site will not necessarily be borne by the Waimanalo sewer using community. We expect that most of the capital and operating cost of the effluent pump station at the Waimanalo Wastewater Treatment Plant will be borne by the Department of Agriculture and the users of the reclaimed water. The cost-sharing arrangement has not yet been negotiated. This issue will be analyzed in detail before design and construction of the reuse facilities is implemented. It would be justified for the City and its sewer users to bear some of the costs since if the effluent were not reclaimed for irrigation, additional costs would need to be expended for the construction and operation of additional injection wells or other effluent disposal facilities. The use of reclaimed water potentially provides water quality benefits by reducing the discharge of nutrients into the groundwater. By properly allocating costs and through federal funding assistance, we anticipate that a "win-win" situation can be achieved. It should also be noted that the City's share of cost for the production of reclaimed water will be shared by all sewer users on Oahu as all the City facilities are operated as a single system (i.e., a single rate structure applies to all sewer users and there is no distinction based on geographic location).

The expense of cleaning the irrigation pipes, if significant due to accumulated grease deposited by Unisyn, would need to be resolved between DOA and Unisyn. If the irrigation reservoir were to be located at the proposed Unisyn site, the grease that may be present in the Unisyn washwater would not impact the transmission line between the treatment plant and reservoir site. This would avoid the possibility of added pumping costs caused by grease accumulation constricting the transmission line. We would expect that a simple grease trap could be constructed to remove the majority of grease if the grease became a significant problem. The reservoir itself may in itself serve to significantly lower the concentration of grease in the effluent since the water would be withdrawn from below the water surface and most of the grease be expected to migrate to the surface.

Fresh Water Springs at Reservoir Site

Based on discussions with the U.S. Department of Agriculture Natural Resources Conservation Service (NRCS), past soil investigation work conducted at the reservoir site in 1981 did indicate that there is alluvial groundwater present at the site. The water table ranged from approximately 50 to 56 feet above mean sea level in elevation and between 6 and 25 feet below the ground surface at the four boring sites investigated. Small artesian springs may potentially occur once the new reservoir is excavated, particularly following wet-weather periods. The reservoir is proposed to be lined with a flexible high density polyethylene liner. NRCS has indicated that additional site investigations will be performed prior to the design of the reservoir facilities. They anticipate that provisions to accommodate the groundwater and

Mr. Joseph Ryan
Page 4
November 6, 1998

possible springs can be readily incorporated into the design as necessary. A similar situation was encountered at another NRCS reservoir site in Waimanalo. Please contact Mr. Michael Hayama of NRCS if you have any further concerns regarding the hydrology of the reservoir site as the NRCS will be performing the design of the reservoir.

We hope that the above responses meet with your satisfaction. A copy of your letter and this response will be included in the final supplemental environmental impact statement. If there are any questions, please feel free to contact our project engineer, Mr. Carl Arakaki at 523-4671. Thank you very much for your time and consideration on this project.

Sincerely,

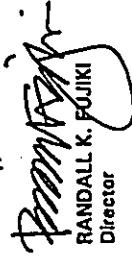

RANDALL K. FUJIKI
Director

cc: Office of Environmental Quality Control
Roy Abe, Hawaii Pacific Engineers

Ko'olaupoko Community Development Plan Coalition
305 Habana Street, Suite 202
Kaliua, Hawaii 96734

RECEIVED

AUG 22 1998

HAWAII PACIFIC
ENGINEERS INC.

Mr. Roy K. Abe, Vice President
Hawaii Pacific Engineers
1132 Bishop Street 1003
Honolulu, Hawaii 96813

Dear Mr. Abe:

Many thanks for your August 19 response to our inquiry about your future plans in Koolaupoko.

Our input to the City on the Koolaupoko Development Plan will be completed later this year when we have covered all the "bases."

Your timely response will certainly help us meet this schedule and it is greatly appreciated. The Coalition is merely collecting information and will not be commenting on the DEIS.

Sincerely,

Donald K. Bremner
Chairman, Infrastructure/
Facilities Committee

August 21, 1998

DEPARTMENT OF DESIGN AND CONSTRUCTION

CITY AND COUNTY OF HONOLULU

650 SOUTH KING STREET, 2ND FLOOR
HONOLULU, HAWAII 96813
PHONE: (808) 523-4564 • FAX: (808) 523-4567

JUDITH HARRIS
SAVOR



RANDALL K. FUJIKI, AIA
DIRECTOR

ROLAND D. LIBBY, JR., AIA
DEPUTY DIRECTOR

DCP 98-348

October 15, 1998

Mr. Donald A. Bremner, Chair
Infrastructure/Facilities Committee
Koolaupoko Community Development Plan Coalition
348 Dune Circle
Kaliua, Hawaii 96734

Dear Mr. Bremner:

Subject: Draft Supplemental Environmental Impact Statement (DSEIS)
for Waimanalo Wastewater Facilities Plan
Koolaupoko, Oahu, Hawaii
TMK: 4-1

Thank you for reviewing the subject document and for your correspondence of August 21, 1998. We acknowledge that the Koolaupoko Community Development Plan Coalition has no comments to offer at this time.

A copy of your letter and this response will be included in the final supplemental environmental impact statement. If there are any questions, please feel free to contact our project engineer, Mr. Carl Arakaki at 523-4671. Thank you very much for your time and consideration on this project.

Sincerely,

RANDALL K. FUJIKI
Director

cc: Office of Environmental Quality Control
Roy Abe, Hawaii Pacific Engineers

Hawaiian Electric Company, Inc. • PO Box 2750 • Honolulu, HI 96840-0001

RECEIVED

AUG 28 1998

HAWAII PACIFIC ENGINEERS INC.



Scott W.H. Seu, P.E.
Manager
Environmental Department

August 24, 1998

Department of Design and Construction
City and County of Honolulu
550 South King Street
Honolulu, HI 96813

Attention: Mr. Carl Arakaki

Subject: Waimanalo Wastewater Facilities Plan

Thank you for the opportunity to comment on your July 1998 Draft Supplemental EIS for the Waimanalo Wastewater Facilities, as proposed by the Department of Design and Construction, City and County of Honolulu. We have reviewed the subject document and have no comments at this time.

HECO shall reserve further comments pertaining to the protection of existing powerlines bordering the project area until construction plans are finalized. Again, thank you for the opportunity to comment on this draft environmental assessment.

Sincerely,

cc: OEQC

Hawaii Pacific Engineers, Inc.
1132 Bishop Street, Suite 1003
Honolulu, HI 96813-2830
Atten: Roy Abe



WINNER OF THE EDISON AWARD
FOR DISTINGUISHED INDUSTRY LEADERSHIP

DEPARTMENT OF DESIGN AND CONSTRUCTION
CITY AND COUNTY OF HONOLULU

550 SOUTH KING STREET, 2ND FLOOR
HONOLULU, HAWAII 96813
PHONE: (808) 523-4564 • FAX: (808) 523-4587



JEREMY HARRIS
CLERK

MANDALL K. FUJIKI, AIA
DIRECTOR
ROLAND D. IBEY, JR., AIA
DEPUTY DIRECTOR

DCP 98-347

October 15, 1998

Mr. Scott W.H. Seu, P.E., Manager
Environmental Department
Hawaiian Electric Company, Inc.
P.O. Box 2750
Honolulu, Hawaii 96840-0001

Dear Mr. Seu:

Subject: Draft Supplemental Environmental Impact Statement (DSEIS)
for Waimanalo Wastewater Facilities Plan
Koolaupoko, Oahu, Hawaii
TMK: 4-1

Thank you for reviewing the subject document and for your correspondence of August 24, 1998. We acknowledge that Hawaiian Electric Company has no comments to offer at this time and reserves further comments until preparation of the construction plans are completed.

A copy of your letter and this response will be included in the final supplemental environmental impact statement. If there are any questions, please feel free to contact our project engineer, Mr. Carl Arakaki at 523-4871. Thank you very much for your time and consideration on this project.

Sincerely,

MANDALL K. FUJIKI
Director

cc: Office of Environmental Quality Control
Roy Abe, Hawaii Pacific Engineers

PUBLIC INPUT DURING PREPARATION OF THE WAIMANALO WASTEWATER FACILITIES PLAN

Input from the general public during preparation of the Waimanalo Wastewater Facilities Plan was received through two primary means. The first was a mail-out survey to residents living in the unsewered coastal areas that are targeted for expansion of the sewer system. The second means of public input was through a series of public information meetings *and a public hearing*. The input received from the public is summarized in the following discussions.

Resident Survey

The detailed investigation of individual wastewater systems in the Waimanalo Wastewater Facilities Plan was conducted due to the strong opposition of a substantial number of residents to the construction of sewers in their neighborhood. As a result of the opposition, a survey of residents living in the unsewered beach lot and Bell street areas (Improvement District Section 2, 3 and 5 as shown on Figures 1-2a and 1-2b) was conducted. The survey was intended to compile additional input on the sewer construction issue and verify that the strong opposition to sewers represented the opinions of the majority of the residents. The survey also was used to gather information on individual wastewater system performance and shoreline water quality problems. The survey, which utilized a mail-in survey form, was conducted in July 1996.

A sample of the survey cover letter and survey form, and a summary of the survey results are presented on the pages following this discussion. There were 402 surveys sent and 176 responses received, which represents a 44 percent return rate. Many of the respondents did not answer all of the survey questions.

A summary of basic information from the survey results is presented in Table 10-1. Other information obtained through the survey include the following:

- None of the respondents indicated that they disposed of unusual wastes other than domestic sewage.
- A number of residents indicated that laundry washwater was used for irrigation purposes.
- Homeowners with problem systems typically reported overflows, odors and the need to restrict water usage to prevent overflows.
- Reported annual costs for maintaining the individual wastewater systems averaged approximately \$65 and ranged from \$0 to \$1500.

**TABLE 10-1
INDIVIDUAL WASTEWATER SYSTEM SURVEY
BASIC INFORMATION SUMMARY**

Item	Number of Responses	Average	Minimum	Maximum
No. of survey responses	176	-	-	-
Lot size, sq. ft.	-	12,400	1,125	130,680
Number bedrooms	-	3.5	0	9
Household size ¹	-	4	0	14
Cesspools ²	157	-	-	-
Septic tanks ²	18	-	-	-
Garbage disposal unit used	57	-	-	-
Wastewater systems with reported problems	30	-	-	-
Observed algae & other coastal water quality problems	63	-	-	-

Notes:

1. Average household size was 3.8 for private beach lot homes and 6.6 for Department of Hawaiian Home Lands homes in the Bell Street area.
2. Cesspools and septic tanks do not total the number of responses as some respondents did not include cesspool/septic tank information.

- Forty-five of 63 respondents (71 percent) who commented on coastal water quality problems noted that water quality problems increased during wet weather. A total of 29 responses noted "muddy waters" (sediment) associated with storm events. A portion of these responses also cited algae problems associated with storm events.
- Fifteen responses noted algal related water quality problems without associating it with wet weather. The responses generally indicated that dry weather algal problems are seasonal and short lived.
- The following causes of water quality problems and sources of pollutants were also noted: raw sewage, ship pollution from military exercises, and litter associated with beach users and boaters, the Kailua WWTP outfall, Waimanalo WWTP injection wells, dairies, and Bellows AFS.

The responses to survey Question No. 14 and 15, which relate to disposal of wastewater by individual wastewater systems or a new sanitary sewer system, are tabulated on Table 10-2.

The results show that 54 percent of the responses to Question No. 14 favored retaining individual wastewater systems if the systems were found to be causing coastal water quality problems. Many of the residents who opposed installation of sewers indicated that they would not be able to afford the costs associated with the new sewer system. In comparison, 76 percent of the responses to Question No. 15 favored retaining their individual wastewater systems if the systems were found not to be the cause of coastal water quality problems. Several of the respondents commented that Question No. 14 was biased and misleading.

There was a strong correlation between those who were having problems with their individual wastewater system and those who answered "yes" to Question No. 15. These residents apparently feel that connecting to the sewer system would be worth eliminating the problems they were experiencing with their individual wastewater system.

In summary, the majority of the surveyed residents favor continuing the use of their individual wastewater systems regardless of water quality issues. They favor remaining on individual systems by a small margin if water quality is being affected by these systems, and are overwhelmingly against sewers if water quality is not being affected.

TABLE 10-2
SURVEY RESULTS ON SEWER CONSTRUCTION ISSUE

Question	Total Responses	Yes	Percent Yes	No	Percent No
<u>Question No. 14:</u> If cesspools and septic tanks <u>are</u> causing a water quality problem along the Waimanalo shoreline, would you want to be hooked up to a sewer system and be willing to pay for all charges (assessment, hookup, and monthly charges)?	157	72	46	85	54
<u>Question No. 15:</u> If cesspools and septic tanks <u>are not</u> causing a water quality problem along the Waimanalo shoreline, would you want to be hooked up to a sewer system and be willing to pay for all charges (assessment, hookup, and monthly charges)?	172	42	24	130	76

Note: Question numbers refer to numbers used on survey form.

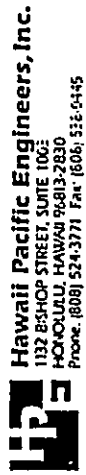

Hawaii Pacific Engineers, Inc.
132 BISHOP STREET, SUITE 1005
HONOLULU, HAWAII 96813-2830
Phone: (808) 524-3771 Fax: (808) 522-0445

Date: July 10, 1996
To: Waimanalo Beach Lot Area Resident
Project: Waimanalo Wastewater Facilities Plan
Subject: Survey of Cesspool/Septic Tank Owners in the Waimanalo Beach Lot Area

Dear Resident,

Our engineering firm has been contracted by the City and County of Honolulu Department of Wastewater Management to develop a wastewater facilities masterplan for the Waimanalo community. One of the key issues of our study is whether the homes in the beach lot area should: 1) be serviced by new sewer lines (with sewage treated at the Waimanalo Wastewater Treatment Plant), or 2) continue to be served by "on-site" cesspools and septic tank systems. We are conducting this mail-in survey to obtain information on your existing sewage disposal system and your opinion on this matter.

Three important factors that we are considering are: 1) impact of cesspools and septic tank systems on the water quality of the Waimanalo shoreline, 2) public health risks and inconvenience from sewage overflows and system overloads, and 3) cost to the homeowner and taxpayers. This survey will provide us with useful information from the homeowners' viewpoint. To evaluate the shoreline water quality issue, our project also involves installing water quality monitoring wells to obtain information on nutrient and bacteria levels makai and mauka of the beach lot area. In a related issue, we are also examining whether there is justification and a need to upgrade cesspools with more costly septic tank systems in the beach lot area. The State Department of Health is also currently reexamining this issue and will be looking closely at our study's conclusions.

Costs related to the sewerage of the beach lot area is significant to the homeowner/tenant. The City currently assesses homeowners \$0.16 per square foot of lot area for new sewer systems. In addition, it will typically cost the homeowner \$2,000 or more to hire a contractor for the sewer pipeline and connection work within the property. Currently, residents on sewer systems typically pay about \$34/month in sewer fees per dwelling (fees vary depending on water usage). In comparison, the typical cost to upgrade cesspools to septic tank systems is on the order of \$10,000 per home.

Your input is important to us. Please take some time to fill the attached survey form and mail it to us in the stamped return envelope by July 26th. Your name, address and phone number are not required for this survey. Copies of the form or specific information on individual homes will not be distributed to any government agency, private organization or individuals. If you are a renter, please give the survey form and this letter to your landlord (providing him/her with appropriate information, particularly on questions 8 through 13 of the survey form).

If there are any questions, please feel free to call me at 522-7425. The contact at the City Department of Wastewater Management for this project is Mr. Carl Arakaki (Ph. 523-4671). You may also want to discuss your concerns on any wastewater issues with your Waimanalo Neighborhood Board representatives. Thank you very much for your time and assistance.

Sincerely,

Roy K. Abe
Roy K. Abe
Project Manager

(Note: The assessment fee is currently \$0.25/1,000 square foot.)

WAIMANALO BEACH LOT AREA CESSPOOL/SEPTIC TANK SURVEY

1. Name (optional): _____
Address (optional): _____
Phone No. (optional): _____
2. Lot size (approximate): _____ square feet or _____ acres
3. Number of bedrooms: _____
4. Number of persons in household: _____
5. Vacation Unit?: Yes _____ No _____
6. Wastewater treatment system: _____ Cesspool _____ Septic tank
7. Do you have and use a garbage disposal unit? Yes _____ No _____
8. Do you know of any unusual wastes (other than sewage/washwater) that go into the cesspool/septic tank? _____
9. About how often do you have the cesspool or septic tank pumped per year? _____ times per year, or _____
10. About how much do you spend per year to pump your cesspool or septic tank? _____
What kind of problems do you have with your cesspool or septic tank (toilets back-up, overflows, odor, etc.) _____
11. If you do have problems, what do you think might be causing them? _____
12. Do you have more problems during the rainy season? Yes _____ No _____
13. Have you noticed algae and other water quality problems or pollution along the Waimanalo shoreline? Yes _____ No _____
If yes, please describe (what, how often, how long, etc.) _____
14. If cesspools and septic tanks are causing a water quality problem along the Waimanalo shoreline, would you want to be hooked up to a sewer system and be willing to pay for all charges (assessment, hookup, and monthly charges)? Yes _____ No _____
15. If cesspools and septic tanks are not causing a water quality problem along the Waimanalo shoreline, would you still want to be hooked up to a sewer system and be willing to pay for all charges (assessment, hookup, and monthly charges)? Yes _____ No _____
16. Other comments: _____

Please mail form to Hawaii Pacific Engineers, Inc. by July 26, 1996
In stamped return envelope provided. Thank you very much!

**WAIMANALO FACILITIES PLAN
INDIVIDUAL WASTEWATER SYSTEM SURVEY**

Survey No.	Lot Size	Bed. room	Res. dents	Va- cation Unit	Cess- pool	Septic Tank	Gar- bage Disp.		Cess- pool Pump Freq.	Annual Pump Cost	If you do have problems with your cesspool or septic tank, what do you think might be causing them?	Rainy Season More Problems?	Have you noticed algae & other water quality problems or pollution along the Waimanalo shorelines?	If systems causing WQ problem do you want to be replaced?		Other Comments
							Y	N						Yes	No	
7		1														
7	11,250	6	6		X		X	0	\$0	None	N	Yes, yellow bloom from Kailua loutlet, untreated returning home			N	This area doesn't need sewer hookup. Retired - income limited
7	12,000		8		X		X	0	\$0	None	N	No			N	
7	130,680	4	3		X		X	0	\$0	None	N	No			N	**Only if there are no alternatives
1	8,000	4	4		X		X	3/year	\$250	Problem: rare backups. Cause: rainy season, increase in use	Y	Yes, algae in surf intermittent	Y		N	
1	4,000	4	4		X			3/year	\$250	Problem: rare backups-cause: rainy season, increase in use						
2	9,000	3	4	N		X	X	Once in 3 years	\$35	None	N	Yes, ocean is often discolored by stream runoff			N	Ocean problems won't be cured by sewer line-problem is with stream pollution and control of stream runoff. We have complained for years - doesn't do any good.
3	10,890	5	1	N	X		X	Add cesspool bacteria annually	\$0	None	N	No			N	No problems.
5	14,500	3	4	N	X		X	2 times in 10 years	None	None	N	Yes, after heavy rains			N*	* WWTP is inadequate - injection wells at WWTP are not adequate at present, and they keep adding new hookups to the present system
7	10,000	2	2	N	X		X	Less than once a year		Odor: overflow from washed/diyer	Y	Yes, polluted stream at Bellows AFS	Y		N	
8	11,250	5	7	N	X		X	Once in 38 years	\$0	None	N	No			N	When we have Kona wind, a foul odor sets into our atmosphere in Waimanalo and stinks whole area, we hope it will be corrected.
9	14,250	3	3	Y	X		X	0	\$0	None	N	No			N	**Would prefer septic tank if nec. -- if it is not broken, don't fix.
10	14,500	6	5	N	X		X	1/year	\$75	None, excellent flow	N	No			N	
12	5,000	1	3	Y	X		X	1/year	\$81	Problem: Toilet backup-overflows. Cause: pipe leading to cesspool was broke, had the line replaced.	N	Yes, after a severe rain storm	Y		N	
15	12,500	9	8	N	X		X	1/month	\$0	One was stopped up-used to sometimes back-up no problems recently, but concerned about future	N	No	Y		N	Two rental properties cesspools becoming clogged, but reluctant to install septic tank and then be required to connect to sewers. City has promised sewers installation since 1960's. Sewers cannot come too soon.
16	5,000	2	1	N	X		X	1/3 years	\$0	None	N	No			N	
17	12,500	8	8	N	X		X	0	\$0	None	N	No	Y		N	
18	12,500	9	8	N	X		X	0	\$0	None	N	No	Y		N	
19	10,000	4	2	N	X		X	0	\$0	None	N	No	Y		N	
21		2	2	N	X		X	0 in 7 years	\$0	None	N	Yes, green bubbles floating - foul smell after heavy rain	Y		N	
22				N	X		X	3/year	\$250	Overflows, tank too small	N	Yes, after rain the water has a green shine	Y		N	
23	14,000	3	2	N	X		X	Once in 20 years	\$0	None	N	Y, after heavy rains, the water becomes murky for about a week or so.	Y		N	None

**WAIMANALO FACILITIES PLAN
INDIVIDUAL WASTEWATER SYSTEM SURVEY**

Survey No.	Lot Size	Bedroom	Restrooms	Vacation Unit	Cesspool	Septic Tank	Garbage Disp.	Cesspool Pump Freq.	Annual Pump Cost	If you do have problems with your cesspool or septic tank, what do you think might be causing them?	Rainy Season More Problems	Have you noticed algae & other water quality problems or pollution along the Waimanalo shoreline?	If systems causing WQ problem do you want to fix them? * = are not		Other Comments
													Yes	No	
26	12,500	4	4	Y	X	X	X	0		None	N	I notice a green slick on the ocean sometimes.	Y	N	
27	11,250	3	5	N	X	X	X	Have not pumped in years		none	N	Yes, shore line water appears to be light green with brown foam on surface.	Y**	N	**Reluctantly....if it isn't broke don't fix it.
29	14,250	2	2	N	X	X	X	None	\$0	None, odor from animal farms bother us more when its Kona weather.	N	No, however horse dung seen at times.	Y	N	After heavy rains, when the river mouths are opened, the ocean looks very polluted
31	8,000	3	4	N	X	X	X	6-8 Times in year	\$500	Toilet backup, overflows into shower - cause?	N	Yes, bright green bubbly stuff floating on the water - often	Y		
33	14,250	3	3	N	X	X	X	< 1/year		Must curtail heavy use occasionally when guests present - call for added chemical treatment	N	Yes	Y**		**But if only if all cesspools are eliminated and treated effluent is not injected into the ground in Waimanalo
34	11,500	2	2	N	X	X	X	0, Chemical treat. works ok if no wash waste		Toilet backups, odor and pumping - cesspool clogged with coconut roots, does not drain especially during high tides and rain.	Y	Yes, slimy green algae 4 to 5 times per year.	Y		
36	4,200	4	3	N	X	X	X	0 in 13 years	\$0	None	N	No	Y*	N	*My property is below the line and will require pumping - expense paid by whom?
37		2	2	N	X	X	X	0		None	N	No		N	
38	11,250	4	2	Y*	X	X	X	2 times visit in last few yrs. only after large occupancy visit	\$80	Normally none, but permanent couple/most visitors must be careful about water use. Cesspool limited capacity and City Parks Dept. overgrown tree roots in cesspool.	N	Yes/no algae/water quality problems at outlets of streams and washed along shore after heavy rains - from agricultural area.	Y		I don't believe they are a problem. Try the non-point source pollution from the streams. Provided the sewer main is installed deep enough for a gravity connection-lowest fixture is roughly 8 ft. below the street and 125 ft. away.
39	16,000	6	3	Y	X	X	X	0	\$0	None	N	Yes, after a strong rainfall - runoff from the streams pollute the ocean	Y	N	Cost is a major factor.
44	11,250	4	2	N	X	X	X	0	\$0	None	N	No		N	We have cows and other animals in the valley. After heavy rains their waste wash to the sea, even dead animals.
50	11,250	3	2	N	X	X	X	0	\$0	None	N	Yes, after heavy rains from the stream		N	No problem, the drains is good: all sand. I have lived in the same place for 50 years.
52	5,825	2	1	N	X	X	X	0	\$0	None	N	No		N	Any shoreline pollution in bay is most likely coming from up country as most pollution comes from state park area.
53	5,500	3	4	N	X	X	X	0	\$0	None	N	Yes, after heavy rainfall		N	
54	11,250	3	2	N	X	X	X	0	\$0	Problem: cesspool monitoring and chemically treated by private contractor through DWWM on regular basis, or it would overflow/backup. Cause: wish we knew so we can save \$87.50 bi-monthly.	N*	Yes, during warm weather, shore waters are bubbly, murky with algae-lasts from week or more	Y**	N**	*Rainy season: from stream runoff. Dry season: from cesspool and sewer injection wells. ** Depends on what is causing the problem.
57	14,000	3	2	Y	X	X	X	0	\$0	None	N	No		N	I am 71 years old. My social security can't even feed me or pay bills.

**WAIMANALO FACILITIES PLAN
INDIVIDUAL WASTEWATER SYSTEM SURVEY**

Survey No.	Lot Size	Bedroom	Residents	Vacation Unit	Cesspool	Septic Tank	Garbage Disp.		Cesspool Pump Freq.	Annual Pump Cost	If you do have problems with your cesspool or septic tank, what do you think might be causing them?	Rainy Season More Problems	Have you noticed algae & other water quality problems or pollution along the Waimanalo shoreline?	If systems causing WQ problem do you want to hook up & assoc. cost?		Other Comments	
							Y	N						Yes	No		
60	11,250	4	4	N	X		X	X	\$0	None	N	No			N	If a sewer system is put in, it should be optional for the homeowner to hook up - not mandatory.	
61	5,260	4	4	N	X		X		\$0	Cesspools very efficient. Beachlots uniquely sited on sand dune, sewer tertiary treated most effectively by anaerobic digestion in sand. A little sewage through much sand unlike WWTP with much sewage, and little sand.	N	Yes, by stream runoff, after heavy rains, and storm drain runoffs			N	A big mistake to bring sewer into beachlots. WWTP is less efficient when plant is working. Hotel food waste will further burden the WWTP beyond its capacity.	
63	1,600	4	5	N		X	X	1-2 per year	\$200	None	N		Occasional algae after heavy rain from drainage ditches		N	I just spent \$10,000 on an upgraded septic tank system, sewage treatment plants cause more problems than they solve. No sewers.	
64	11,250	3	2	N	X		X	0	\$0	None	N		Yes, yellowish bubbles in water, mostly in summer	Y		We have been here for 47 years, and have not had any problems with our cesspools.	
66	11,200	4	6	N	X		X	0 in 20 years		None	N		Green water, brown water, typical with heavy rains flushing streams			Nearly impossible to prove that cesspools have a measurable effect on shoreline water quality in Waimanalo Bay due to effects of nearby WWTP injection wells. Loss of septic tanks and cesspools would also increase potable water consumption for irrigation.	
69	11,000	3	4	N	X		X	0	\$0	None	N		Yes, after rains, top soil and debris from the streams			N	
70	11,000	2	1	N	X		X	0	\$0	None	N		Yes, algae infrequent 1-2 day			N	
71	5,750	6	5	N	X		X	Once in 24 years	\$750	None	N			Y		N	
72	5,625	2	2	N	X		X			None	N					N	
74	11,700	3	4	N	X		X	0	\$0	None	N					N	
78	11,250	3	3	N	X		X	0	\$0	None	N					N	
82	5,100	3	2	N	X		X	0		None	N					N	No changes needed.
87	9,000	3	2	N	X		X	0		None	N			Y		N	We use enzymes on a regular schedule.
88	7,080	3	4	N	X		X	Same time, once a year	\$75	Prob: toilet leaking, cause: toilet leaking	N			Y**		N	** It all depends on the cost per lot.
89	7,785	3	5	N	X		X	Same time, once a year	\$75	Leaking toilet	N			Y**		N	** It all depends on the cost per lot.
90	5,000	2	1	N	X		X	0	\$0	None	N		Yes, usually after heavy rains, Foremost Dairy waste into the sea.			N	
92	12,500	2	3	N	X		X	0		None	N					N	For 1 to 3 people in the household, the cesspool has been adequate without trouble all these years. The added expense of a municipal sewage treatment system will add to the burdens of every household.
93	11,500	3	4	N	X		X	Last pumped 5 years ago	\$0	None, if treated annually with a bacterial additive	N		Yes, yellow bubbles floating in water	Y		N**	** O.K... sewage problems from overloaded treatment system seem much more severe than from cesspools. Sewer system would certainly lead to more development and commercial use and worsen wastewater problems. Would be foolishly costly and inadequate solution for all concerned.
94	12,000	2	2	N	X		X	0	\$0	None	N					N	

**WAIMANALO FACILITIES PLAN
INDIVIDUAL WASTEWATER SYSTEM SURVEY**

Survey No.	Lot Size	Bed. room	Resi. dents	Va- cation Unit	Cess- pool	Septic Tank	Gar- bage Disp.		Cess- pool Pump Freq.	Annual Pump Cost	If you do have problems with your cesspool or septic tank, what do you think might be causing them?	Rainy Season More Problems	Have you noticed algae & other water quality problems or pollution along the Waimanalo shoreline?	If systems causing WQ problem do you want to be hooked up to sewer?		Other Comments
							Y	N						Yes	No	
97	11,280	3	4	N	X		X	0	\$0	None	N	Yes	Y			
99	11,250	5	4	N	X		X	0	\$0	None	N	No	Y			
102	8,000	3	2	N	X		X	0	\$0	None	N	Yes, green slime and green bubbles too often-as long as one week.				We all know where green bubbles come from. It will do no good if streams are not cleaned up and stream flow maintained.
103	6,800	3	3	N		X	X	0	None	None	N	Yes, after each major rain, an algae bloom arises.	Y			
105	9,375	4	4	N		X	X	0	\$0	None	N	Yes, after heavy rains with storm runoff from mtn. area also problems at WWTP causes green-yellow color.				
109	11,500	2	2	N	X		X	1 in 20 years	\$0	None	N	This is a very inaccurate question few people can comment on pollution-algae does not necessarily imply pollution.				#14 :not a fair question you can't link cess. and septic tanks in the same question-if my cesspools were causing problems, I might choose septic. Your cover letter may not accurately represent the costs immediate and long term of sewer hookup.
111	12,000	4	6	N	X		X	0	None	None	N	No	Y			I have lived here all my life (49years) We have never had problems with our cesspool. We cannot afford all these changes.
113	11,250	3	4	N	X		X	1 in 43 years	None	None	N	No				
114	11,250	5	6	N	X		X	0	\$0	None		No				I have no problems with my cesspool. I am perfectly satisfied and do not want the cost to put in a sewer.
116	10,000	3	4	N	X		X	0	\$0	None	N	No	Y			If data shows that beachlots are the source: why should we pay to hook up to sewer when the city is pumping a million gallons a day into the ground less than a 1/4 mile away. Why should we upgrade to septic system which is more costly when cesspools with proper maintenance, work just fine.
117	14,000	3	2	N	X		X	0	\$0	None	N	No	Y			We do have cesspool services with Transvac Environmental under C & C contract.
121	10,890	3	3	N	X		X	0	\$0	None	N	Yes, mostly people rubbish from beachgoers and boaters.				Am satisfied with the current waste system - would not like to see it changed.
127	11,000	3	7	N	X		X	0	\$0	None	N	No				
129	12,000	4	10	N		X	X	2/year	\$65	None	N	No	Y			
132	15,000	2	3	N	X		X	2 in 40 years	\$80	None	N	No	Y			
137	11,250	3	4	N	X		X	0 in 4 years	None	None. Works like a charm. We do not use anything but soap and dishwashing detergent. Our laundry water goes into the garden.	N	Yes. After a rain, 1" + plume always starts at Inoaole Stream and goes down to beach lots				You need to divide the area for water testing. I believe the only lots that could be contributing to water quality problems are along the beachfront. If at all, sewer should be installed along Laumalo only.
138	11,000	4	5	N	X		X	1/month	\$0	None	N	No				Don't spoil a system that is working fine. Also, Waimanalo's sewage plant is at its maximum operation capacity- wouldn't you be adding to their problems by adding the beachlot units? Leave our area as is.
139	11,250	3	4	N		X	X	Less	\$0	None	N	Yes, dirty water from stream runoff following rains				We do not want to be hooked up to the city sewer.

**WAIMANALO FACILITIES PLAN
INDIVIDUAL WASTEWATER SYSTEM SURVEY**

Survey No.	Lot Size	Bed- room	Resi- dents	Va- cation Unit	Cess- pool	Septic Tank	Gar- bage Disp.	Cess- pool Freq.	Annual Pump Cost	If you do have problems with your cesspool or septic tank, what do you think might be causing them?	Rainy Season More Problems?	Have you noticed algae & other water quality problems or pollution along the Waimanalo shoreline?	If systems causing WQ problem do you want to fix them?		Other Comments
													Yes	No	
141	11,250	3	2	N	X		X	0 in 45 years	\$0	None	N	No, only when the State or City open up the flood gates to dump the excess of effluent			My wife and I are on a fixed income and I am almost 70 yrs old and I don't need another loan or a big bill to pay for the improvements when I have only a few more years to go.
143	11,250	2	2	N	X		X	None	\$0	None	N				
144	11,483	4	5		X		X	8 years, on contract				Yes, rash	Y	Y	
146	9,800	3	4	N	X		X	0/10 years	\$0	Cost per year: "I actually save money"	N	No			Resident for 39+ yrs and have never noticed problem with water quality and have no complaints with 38 year old cesspool service problems. Would prefer to stay with cesspool.
149	11,250	4	5	N	X		X	0/20 years		None	N	No	Y**	Y**	**Would like sewer system either way, but wouldn't want to pay for all charges, assessment, hook-up, & monthly charges.
151	10,250	2	2	N	X		X	0		None	N	No, only after heavy rains flush out the stream by Tinker Road			Beachlots don't have a problem because of sand layer, but other areas where clay soil clogs may better be served by sewer.
154	11,000	2	1	N	X		X	Checked once a year, never needs pump.	\$0	None	N	Yes, during the month, occasional - once or twice, green slime and foul smell			
156	11,250	3	5	N	X		X	0	\$0	None	N	No			**I believe that it is not individual tanks, but inadequate City facility and dumping in local streams
157	11,250	3	3	N	X		X	0		None	N	Yes, for about 1 week after Pacific film exercises - like ship dump			Pollution in our area comes from offshore dumping and Sandy Beach overflow problems for Hawaii Kai.
158	1,125	3	5	N	X		X	0	\$0	None	N	No			Retired and on fixed income-no money for assessment and too old.
161	15,000	2	2	N	X		X	0	None	None	N	No			Have been in Waimanalo since 1946.
163	15,000	4	3	N	X		X	0	\$0	None	N	No			
164	15,000	3	2	N	X		X	0 in 27 years	\$0	None	N	Yes, yellow colored bubbles during certain times of year in ocean.			I really need to be convinced that sewer is the way to go for us. My understanding is the existing sewer plant is inadequate, why add more households if we are not having problems. Fix existing problems. I have not known the beachlots to have problems with cesspools.
167	11,400	5	7		X		X	0 in 10 years	\$0	None		No			This thing (Waimanalo's Wastewater Treatment Plant) is what smells! This is the dairy. -- How do you know what's coming from the cesspools & what's coming out as runoff from dairy's agriculture?
168	11,250	5	6	N	X		X	0 in 44 years		None	N	No			
169	11,500	3	4	N	X		X	24/year, on contract	\$0	Overflows, odor from toilet	Y	No			We would like to be on a sewage disposal system.
170	11,250	3	5	N	X		X	0	\$0	None	N	No			

**WAIMANALO FACILITIES PLAN
INDIVIDUAL WASTEWATER SYSTEM SURVEY**

Survey No.	Lot Size	Bedroom	Residents	Vaccination Unit	Cess-pool	Septic Tank	Garbage Disp.	Cess-pool Pump Freq.	Annual Pump Cost	If you do have problems with your cesspool or septic tank, what do you think might be causing them?	Rainy Season More Problems	Have you noticed algae & other water quality problems or pollution along the Waimanalo shoreline?	If systems causing WQ problem do you want to hook up & assoc. cost?		Other Comments
													Yes	No	
171	13,389	5	5	N	X		X	2/12 years	\$90	None	N	Yes, raw sewage	N		For years, cesspools in Hawaii did nothing to water supply-our beaches are being ruined because of the sewage plants and their failures to operate properly. Not in favor of sewer system or septic system-still need to pump septic with private company and they dump into sewage plants. overflows, runs into bay. Beachlots there for 50-60 years with cesspools, leave it alone.
172	12,550	3	3	N	X		X	0 in 30 years		None	N	Yes, Usually in the spring, last few days, old Waimanalo residents say this happened 20-30 years ago.	N**		** It has to be proven that there are real problems.
174	11,018	3	6	N	X		X	0		None		Yes, dirty and brownish - rainy season	Y		If the C&C decides to install a sewer system, why don't they go ahead with the project under the law.
178	17,500	6	4	N	X		X	Sulfuric acid monthly by City contractor	\$0	None, but for improvement and sanitation conditions I would prefer to be hooked up to an efficient sewer system	N	No	Y		Regret that City cancelled the previous plans to install sewer system along Launalo street.
179	7,500	3	2	N	X		X	0	\$0	None	N	No	Y		
180	10,890	4	5	N	X		X	2 in 35 years	\$90	None	N	Yes, plastics and nets on the beach. This question is useless unless person goes to beach daily.	Y		* Scientific and well explored proof would need to be gathered first and the wastewater treatment plant capacity increased considerably first--the Waimanalo WWTP is way over capacity as it is.
185	15,000	3	4	N	X		X	0 in 51 years		None	N	No			
186	10,000	2	2	N	X		X	0 in 36 years		None	N	No			
188	10,000	4	6	N	X		X	0 in 51 years	\$0	None	N	No			
189	11,250	6	5	N	X		X	0		None	N	No			
190	11,250	3	3	N	X		X	0 in over 11 years	\$0	None	N	No			Is the Waimanalo WWTP able to handle the beachlots plus the homestead lots that are not hooked up to sewer line already in place?
192	11,250	3	8	N	X		X	1 in 13-14 years		None	N	Yes, Water along Waimanalo beachlots is clean - water around Bellows is murky and green.	N		If there is nothing wrong, don't fix it.
192		2		N	X		X	1 in 13-14 years		None	N	Yes, Water along Waimanalo beachlots is clean - water around Bellows is murky and green.	N		
195	9,700	3	1	N	X		X	2 in 29 years		None		No	**		** Only as a last resort
197	8,000	4	1	N	X		X	0	\$0	None	N	No			
200	11,000	2	2	N	X		X	0	\$0	None	N	No	Y		
201	11,250	2	4	N			X	0 in 9 years	\$0	None	N		Y		
204	11,250	3	5	N	X		X	0 in 20 years	\$0	None	N	No			
209	11,250	3	4	N	X		X	0		None	N	No			
218	11,250	3	3	N			X	0		None	N	Yes, shore line water appears to be light green with brown foam on surface.	Y*		* Reluctantly

**WAIMANALO FACILITIES PLAN
INDIVIDUAL WASTEWATER SYSTEM SURVEY**

Survey No.	Lot Size	Bedroom	Restrooms	Vacation Unit	Cesspool	Septic Tank	Garbage Disp.		Cesspool Pump Freq.	Annual Pump Cost	If you do have problems with your cesspool or septic tank, what do you think might be causing them?	Rainy Season More Problems	Have you noticed algae & other water quality problems or pollution along the Waimanalo shoreline?	If systems causing W/O problem do you want to fix it? - are not		Other Comments
							Y	N						Yes	No	
219	11,200	4	5	N	X		X	X		Sand piping in - getting shallow	N	No	Y			
220	11,250	5	7	N	X	X	X	0 in 5 years	\$0	None	N	Yes, due to dairy stream runoff usually after heavy rains the stream brings it to the bay.	N	N		If any pollution is taking place it is by the dairy runoff, not the cesspools or septic systems as your studies will show.
221	11,250	3	3		X		X				N	No		N		
225	10,500	3	3	N	X	X	X	1	\$75	None	N	Yes, Animal waste, caused by heavy rains which flood the farm areas and carries to the shore.	N	N		1. I have to be convinced that septic tanks or cesspools are primary cause of water quality problems. 2. The push to convert the beachlot area into sewer system by City will increase their income by 143,350/year. 3. Total cost of converting to system over 15 years = \$27,645 vs. \$10,900 for a septic tank. This does not include increase to City's assessment or water usage.
227	9,264	3	5	N	X		X	2 times several years ago		Problem: Toilet back-up -- Cause: Plugged by toilet papers...	N	No	Y			
230	12,400	5	6	N	X		X	2/year	\$75	None	N		Y			
231	11,250	2	2	N	X		X	0	\$0	None, rise and fall of the water	N	No	Y			Waimanalo's current injection well treatment plant is currently overloaded as is. Plant never lived up to its projected capacity. Wells and outfalls are unlikely to provide a seriously improved ocean water quality over the possible cesspools pollution factor we now may have.
233	11,250	5	3	N	X		X	1 in 18 years	\$85	Table	N	No	Y			
234	11,000	3	3	N	X		X	0 in 15 years	\$0	No problems in 16 years	N	Yes, algae: "Waimanalo Yellow" for years...nutrient source is unknown...scientist at Oceanic Institute ...	Y*	N		*I have no faith in the ability of the C&C WW Department to manage Honolulu's sewage plants in an environmentally sound manner. I believe septic is preferable, even though sewer is clearly a better option in the long term.
237	11,000	4	4	N	X		X	0	\$0	None	N	Yes, 25 years, as long as I have been here.	Y	N		*Only if mine was causing a problem. If a problem exists with individual systems, then they should be evaluated individually.
239	15,000	3	3	N	X		X			Odor ---cause: don't know	N	No	Y			
240	20,000	3	4	N	X		X	0 in over 30 years	\$0	None	N	No		N		*Cesspool and septic tanks are not causing a water quality problem. -- I am sick and tired of this effort to try to force an unneeded sewer system down our throats and I'll fight it every inch of the way as we did 4 years ago. The beachlot area does not need another sewer system.
242	10,000	4	4	N	X		X	2 in 28 years		None	N	No	Y			
245	13,750	4	5		X		X	2-3/year	\$240	Overflows, odor, bad roach problem	Y	Yes, brown bubbles	Y			Bacteria levels should not only be checked by C&C and state organizations, but by other environmental organizations such as the Sierra Club, Surf Rider Foundation, and The Nature Conservancy.

**WAIMANALO FACILITIES PLAN
INDIVIDUAL WASTEWATER SYSTEM SURVEY**

Survey No.	Lot Size	Bedroom	Residents	Vacation Unit	Cesspool	Septic Tank	Garbage Disp.	Cesspool Pump Freq.	Annual Pump Cost	If you do have problems with your cesspool or septic tank, what do you think might be causing them?	Rainy Season More Problems	Have you noticed algae & other water quality problems or pollution along the Waimanalo shoreline?	If systems causing WQ problem do you want hookup & assoc. cost?		Other Comments
													Yes	No	
248	12,000	5	5	N	X		X	Chemically treated once a month	None in 10 years	N	No	N	Yes	No	Leave well enough alone.
252	11,250	3	3	N	X		X	0	None	N	No	N	Yes	No	No need
254	11,600	3	3	N	X		X	0	None	N	No	N	Yes	No	If it's not broke leave us alone
255	11,500	2	1	N		X	X	0	None	N	No	N	Yes	No	I am a very old lady - obviously am not interested in improving my property paid for about 25 yrs ago.
257	22,500	4	2	N		X	X	0	None	N	No	N	Yes	No	Yes, lots - green bubbles turning water yellow green - for couple days.
261		4	3	N	X		X	Chemicals once a month	None	Y	No	N	Yes	No	
262	7,500	4	3	N	X		X	0	None	N	No	N	Yes	No	
267	10,000	4	2	N	X		X	0	None	N	No	N	Yes	No	
268	11,000	5	6	N	X		X	0	None	N	No	N	Yes	No	No, only after heavy rains - mud.
274		1		Y					None	N	No	N	Yes	No	I lived here for 65 years and no problem. Only too many people. That's the problem.
274	12,000	4	5	N	X		X	Have occasional need when lots of guests, but not for years.	Excessive use (too many guests)	N	Yes	Y*	Yes	No	Yes, brown gunk in water after heavy rains from stream emptying into bay (animal sewage).
275	13,000	3	3	N	X		X	Once in 2 years	None	N	No	N	Yes	No	During heavy rains, the shore and ocean are muddy from the streams.
277	12,000	3	5	N	X		X	5 / per year	Problem: After being pumped out, its full of sea water in 3 day or 4 days Cause: Full moon, high tide, ground wet	Y	Yes, green algae	Y	Y	Y	What makes the treatment system better when it overflows?
279	10,000	5	4	N	X		X	0	None	N	No	N	Yes	Y	Will be constructing a septic tanks and leach field (HNS) in place of cesspools approximately 1 year.
284	11,250	2	3	N	X		X	1 / year	None	N	No	N	Yes	Y	
285	11,250	4	4	N	X		X	1/5 years	None	N	No	N	Yes	Y	
286	15,000	3	3	N	X		X	0	Odor	N	No	N	Yes	Y	
288	7,000	0	0	N	X		X	12/year	Overflows when raining hard	Y	No	N	Yes	Y	
291	15,000	2	2	N	X		X	1 / year	None	N	No	N	Yes	Y	
294				N	X		X	8-10 / year depend on rain	Nothing out of the ordinary - rain only problem	Y	No	N	Yes	Y	The only problem is rain - only pumps when rains. No rain, no pump
295	8,000	0	0	Y	N		X		None	Y	No	N	Yes	Y	I would definitely hook up to a sewer, but not willing to pay all of the charges, only some. I definitely approve of a sewer system, but treatment plant must be improved to accept a larger volume of sewage.
302	5,300	3	5	N	X		X	1/year	Only one back-up in the last 3 years -- because cesspool was full	N	Yes	Y	Yes	Y	Yes, a green oily film, yellowish bubbles, sometimes makes you itchy seen more often within last 2 years.

**WAIMANALO FACILITIES PLAN
INDIVIDUAL WASTEWATER SYSTEM SURVEY**

Survey No.	Lot Size	Bedroom	Residents	Vaccination Unit	Cess-pool	Septic Tank	Garbage Disp.	Cess-pool Pump Freq.	Annual Pump Cost	If you do have problems with your cesspool or septic tank, what do you think might be causing them?	Rainy Season More Problems	Have you noticed algae & other water quality problems or pollution along the Waimanalo shoreline?	If systems causing WC problem do you want to hook up & assoc. cost?			Other Comments
													Yes	No	Yes	
304	9,000	2	2	N	X		X	I don't take count	\$414	Problem: toilets, sinks back up. Cause: cesspool needs pumping	N	No			**Would only pay for a sewer line, no septic tank. A septic tank would be located on my property and I don't want to set aside area for it. I want every sq. ft. to be used for adding on to my home. We were supposed to have a sewer line a few years ago, what happened?	
305	20,000	3	3	N	X		X	0		None	N	No			To pay for hookup, assessment, and monthly charges would put the family into a financial situation.	
306	5,500	3	2	N	X		X	0/many years	\$0	None	N	No				
307	7,500	3	4	N	X		X	3 times in 1995, April, June & December	\$200	Cesspool built in 1981, no problems until Jan. 1995. Shower started to back up and cesspool was pumped, monitored and chemically treated. -problem: grease and scum on sides	N	No			Since treatment and precautionary pumping last Dec. and changing back to Amway laundry detergent, there have been no problems.	
308	11,250	6	8	N	X		X	0	\$0	None	N	No				
311	27,878	4	10	N	X		X	0	\$0	None	N	Yes, I see some green chemicals in the ocean and that's from the WWTP			Get rid of the WWTP, it is polluting our ocean and killing our livelihood.	
313	21,780	5	6	N	X		X		\$0	Ground cover above cesspool has a concave appearance Cause: sand seeping into small cracks around cover	N	Yes, once in a while, the water is greenish only on warm/calm days.			This greenish water color appears only in front of my house for many years.	
314	18,730	3	7	N	X		X	1/year	\$80	None	N	No			Hoping others will want to hook up to the City sewer system, long overdue.	
315	14,520	6	7	N	X		X	1/year		Overflows -- cesspool too small.	N	No			Sewer lines stopped at Nelu Street several years ago. We've been waiting since then for a hook up.	
316	14,000	4	7	N	X		X	0	\$0	None	N	No				
322		5	7	N	X		X	0	\$0	None	N	No				
327	21,780	4	9	N	X		X	4/year	\$360	Problem: overflows cause: poor seepage	Y	No				
328	21,780	3	2	N	X		X	0	\$0	None	N	Yes, seaweed once a year - few days				
330	3,914	3	0	N	X		X	0		None	N	No				
334	25,000	4	6	N	X		X	2 times prior to 2 gal. acid monthly - not pumped since then		Water levels about 1 to 2 feet from cesspool top, toilet backup, overflows, odor, etc. not experienced yet. Currently, all wastewater (laundry) is emptied on the lawn.	Y	No			* Only monthly charges. OHA should pickup assessment and hook up charges.	
336	21,780	3	14	N	X		X	0	\$0	None	N	No				
347	19,500	4	4	N	X		X	0	\$0	None	N	No			Don't want to be hooked up. we have no cesspool problems-don't want to waste money on what we don't need.	
348	17,000	5	5	N	X		X	0	\$0	None	N	No				
350	10,000	3	4	N	X		X	0	\$0	None	N	Yes, after storms, runoff from ruddy or shoreline.	Y			

**WAIMANALO FACILITIES PLAN
INDIVIDUAL WASTEWATER SYSTEM SURVEY**

Survey No.	Lot Size	Bedroom	Residents	Vacation Unit	Cesspool Tank	Septic Tank	Garbage Disp.	Cesspool Pump Freq.	Annual Pump Cost	If you do have problems with your cesspool or septic tank, what do you think might be causing them?	Rainy Season More Problems	Have you noticed algae & other water quality problems or pollution along the Waimanalo shoreline?	If systems causing hook-up & assoc. cost?		Other Comments																
													Yes	No																	
355	15,000	4	4	N	X*		X	1/year	1,000*	Overflow of sewage into yard, chemicals have to be poured into hole to prevent overflows * (total cost of chemicals, maintenance of pumps, etc. exceeds \$1000)	Y	Y	Y		Definitely. In the long run it will be cleaner and safer and possibly cheaper.																
356	20,001	4	2	N	X		X	0/27 years	\$0	None	N		N	N		I do not want to be on the sewer - we would have to pump it up -- cost too high.															
357	1,500	3	3	N	X			0	\$0	Had toilet backups - or more correctly, toilet dumping out under the house through overflow pipe	Y*			N																	
360	12,624	3	2	N	X		X	0	\$0	None	N		N	N																	
371	32,670	3	7	N	X		X	--		None	N		N	N																	
372	10,000	5	13	N	X		X	0	\$0	None	N		N	N																	
383	16,000	6	9	N	X		X	0	\$0	None	N		N	N																	
395	21,780	3	3	N	X		X	Chem. treated once per month.		None	N		Y			Sewer system preferred.															
397	11,000	4	4	N		X	X	0	\$0	None	N		N			I would want the hook up optional and not mandatory at the time it occurs.															
401	10,000	3	2	N	X		X	0	\$0	None	N		N																		
402	7,190	3	3	N	X		X	0/many years	\$0	None						Question 15 is broad. WWTP currently in area is believed to be the polluter. WWTP are nationally unsuccessful, definite polluters & odor problem.															
Total										12,080,366	601	680	11	163	157	18	135	16,876	149	15	3	68	83	139	129						
Avg										12,080,366	3.5	4.0																			
Min										1,125	2.0	2.0																			
Max										213,850	7.8	14																			

Notes:
 1. Information based on survey of cesspool/septic tank owners in the Waimanalo Beach Lot Area in July 1996. There were 402 survey forms sent out.
 2. Annual average pumping cost is not necessarily accurate reflection of costs, since some residents are on City contract.
 3. None of the survey responses indicated unusual wastes (other than sewage/wastewater) are disposed to the cesspool/septic tank.
 4. Responses Nos. 54, 302, and 334 are not included in the count totals as to whether hookup is desired, because there was more than one response for both of the questions. Response No. 195 is not included for "if systems are causing..." since no preference was indicated. Response 234 is not included in the "if systems are causing..." count totals because two responses were received for the question.
 5. Comments have been edited to include only comments relevant to water quality, individual wastewater systems and sewers.

Public Information Meetings

To obtain input from the Waimanalo residents, a close working relationship was established with the Wastewater Advisory Committee of the Waimanalo Neighborhood Board. Four meetings were held with the Advisory Committee and the general public at the Waimanalo Public and School Library.¹ The community was informed of meeting dates and times through announcements in the Waimanalo New community newspaper, distribution of flyers and/or the meeting agenda, and by personal contact through the Wastewater Advisory Committee.

Brief summaries of public input obtained from the meetings are presented below. The meeting agendas/notices, pertinent handout materials, and attendance lists are presented on the pages which follow.

The first public information meeting was conducted by the City Department of Design and Construction (formerly Department of Wastewater Management) on November 14, 1995 prior to the start of the Waimanalo Wastewater Facilities Plan project. Approximately six Waimanalo residents attended the meeting. Mr. Felix Limtiaco, former Director of the Department, provided an overview of the facilities plan project and a brief historical background of the wastewater facilities in Waimanalo. The residents attending the meeting indicated that there was a concern about high enterococci levels in the streams and at the beaches, particularly near the mouth of Waimanalo Stream. One resident felt that cesspools are well suited for the beach lot area due to effective treatment of the sewage by the Jaucas sand in which the cesspools are located. The general consensus was that the Wastewater Advisory Group should work closely with the consultants.

The Department of Design and Construction (DDC) and its consultant, Hawaii Pacific Engineers, Inc. (HPE), held a meeting with the Wastewater Advisory Committee on March 16, 1996. An overview of the project scope and issues was presented by HPE (see attached agenda). The residents attending the meeting stated that the water quality problems appeared to be caused by nonpoint source of pollution discharging to the streams during storm conditions rather than from the cesspools. It was indicated that holding ponds recently constructed for the dairy appeared to have improved the situation. The residents indicated that the DOH policy of requiring septic tanks/leaching fields is not warranted and that the cost of the collection and centralized treatment system is a major concern. The use of a large leaching field at the Bellows AFS was proposed in lieu of injection wells. One resident indicated that the proposed percolation tests to determine the feasibility of using septic tank systems

¹Two of the four meetings were with the Wastewater Advisory Committee but these meetings were also open to the general public.

in the coastal areas are unnecessary since the area *consists* primarily of sand. It was indicated that a more comprehensive program to identify whether bacteriological contaminants and nutrients from cesspools are a problem, and the mechanisms by which treatment and nutrient transport occur.

DDC and HPE held a followup meeting with the Wastewater Advisory Committee on October 19, 1996. An information summary (see attached pages) was distributed. The general findings of the project to date were discussed by HPE. The proposed groundwater monitoring study to be conducted by the University of Hawaii was discussed. Several residents felt that the study would not show the true treatment efficacy of the cesspool system. Issues raised included the location of the monitoring wells near the cesspools, localized uptake of cesspool nutrients by trees, and lack of representative data due to the limited number of wells. HPE explained that there were budget limitations on this work and the study is only intended to provide general indication of onsite treatment system impacts. One resident noted that he has observed sediments (cloudy plume) in the reef area approximately a mile offshore, and felt that the quarry may be contributing surface drainage directly to the coral basal aquifer. Another resident expressed concern on whether the agricultural lots could be relied on in using the reclaimed water and asked whether the proposed end users in the agricultural lots were owners or short term leaseholders. The resident also stated that the currently available agricultural water is not being fully used by the farmers. HPE indicated that the State Department of Agriculture will be consulted on these issues.

DDC and HPE held a general public information meeting on July 30, 1997. HPE provided a summary of the findings and conclusions from the prefinal Waimanalo Wastewater Facilities Plan report. A resident discussed the possible existence of a spring at the Wing King Reservoir and the possibility of a seepage pit at the quarry site affecting groundwater flow patterns. Several residents stated that there was no need for effluent irrigation water. It was also indicated that the 1.9 acre of land at the Wing King Reservoir is insufficient for the new effluent reservoir.² Another resident indicated that the reservoir is in poor condition and a potential hazard to residents living below them. The general consensus of the meeting participants was that there is a dire need to upgrade the Waimanalo WWTP and that funding issues between the State and City must be resolved.

²Subsequent discussions with the State Department of Agriculture indicated that areas proposed for effluent irrigation experience water shortages during certain times of the year and additional land would be cultivated if additional water was available. It was also indicated that the new effluent reservoirs would extend into the adjacent parcel.

HPE also conducted a brief presentation on the Waimanalo Facilities Plan project at the August 11, 1997 meeting of the Waimanalo Neighborhood Board. Several residents questioned the need for the wastewater facility improvements, particularly to produce reclaimed water for irrigation. Dr. Chip Fletcher of the Geology and Geophysics Department of the University of Hawaii was a scheduled guest speaker at the meeting on a different topic. Dr. Fletcher commented that Waimanalo may have permeable coral outcrops that may be capable of discharging effluent from the lower geologic stratum.³

³A followup meeting was held with Dr. Fletcher to obtain additional information. See discussions in Chapters 3 and 5.

MEETING AGENDA
(continued)

City and County of Honolulu
Department of Wastewater Management

AGENDA FOR MEETING WITH CITIZEN ADVISORY GROUP
ON WAIMANALO WASTEWATER FACILITIES PLAN

DATE/TIME: MARCH 16, 1996, 9:00 AM

LOCATION: WAIMANALO PUBLIC LIBRARY

PURPOSE: To obtain citizen input on the Waimanalo Wastewater Facilities Plan currently being prepared by the City Department of Wastewater Management and Hawaii Pacific Engineers, Inc.

The primary focus of this meeting will be on development of a field testing program to evaluate the feasibility and cost-effectiveness of utilizing onsite wastewater disposal systems (cesspools and septic tank/leaching field systems) in lieu of sewer collection systems and centralized treatment.

MEETING
AGENDA

- I. Introductions
- II. General Project Background
- III. General Discussion of Onsite Wastewater Disposal Systems
 - A. Types (cesspools, septic tank/leaching fields, others)
 - B. Feasibility and Cost-Effectiveness Factors (including discussion of findings of past studies and specific factors applicable to Waimanalo where possible)
 1. Public health protection (sewage spills and backups; exposure to pathogens)
 2. Cost (construction/maintenance; system size; soil conditions)
 3. Regulatory constraints (State Department of Health policies and Chapter 62 regulations)
 4. Water quality factors (migration of nitrates and other nutrients via groundwater to streams and nearshore waters)

Page 1 of 2

5. Physical and practical limitations (lot sizes; groundwater; existing structures/landscaping; etc.)

IV. Proposed Field Investigations

A. Percolation Testing Program

1. Purpose: To determine general suitability of cesspools and septic tank systems in Waimanalo (i.e., to verify capability of soils to leach wastewater into the ground at satisfactory rates while providing sufficient removal of contaminants from the wastewater)
2. Discussion of test procedures
3. Selection of possible test sites
4. Testing program schedule

B. Groundwater Monitoring Wells Program

1. Purpose: To evaluate the relative impacts of onsite wastewater systems on water quality (primarily nutrient levels) as compared to other possible sources of pollution (such as agricultural wastes and agricultural fertilizers).
2. Discussion of relationship between this Facilities Plan and research being conducted by Ms. Darla Inglis (Elswick) of the University of Washington for the Waimanalo Watershed Council
3. Discussion of investigation approach
4. Selection of possible monitoring well sites
5. Monitoring wells program schedule

V. Other Discussions (time permitting)

Note: The discussions at the meeting are intended to be informal and participants are encouraged to provide input and ask questions throughout the meeting.

Page 2 of 2

Waimanalo Facilities Plan Fact Sheet

The Waimanalo Facilities Plan project has been initiated by the City Department of Wastewater Management to create a comprehensive long-range planning document for conveyance, treatment and disposal of wastewater in Waimanalo.

The previous facilities plan was prepared in 1984 and is now outdated. The new plan will be based on current and 20 year projections of population, flow, sewer needs, pump station needs, treatment needs, effluent disposal needs and reuse opportunities, and solids handling needs within the planning area. The plan will also take into account other City, State and Federal plans for wastewater service within the planning area.

The planning area is bounded by the Keolu Hills on the north, Waimanalo Bay on the east, Makapuu Point on the South, and the Koolau Mountain Range ridge line on the west.

The facilities plan will determine the direction of policy in various aspects of wastewater management planning. The plan will investigate and define policy on sewerage of currently unsewered areas in the planning area from an economic, public health and environmental perspective. The planning area includes 1,848 sewer and 741 unsewered single family housing units. The facilities plan will include recommendations for improvements in the wastewater treatment plant if required to increase capacity, increase redundancy and reliability, minimize effluent pollutant levels of treatment operations. Alternatives will be explored for the production and use of some or all of the effluent from the plant for reuse. The effluent is currently injected into an underground aquifer. The adequacy and effectiveness of sludge stabilization and handling will be examined. Each of these aspects of the plan must be viewed as a component of the overall system that must be optimized. The recommendations of the plan will be implemented through individual capital improvement projects. The facility plan will be prepared in accordance with state and national environmental assessment requirements, which may require that an environmental impact statement be prepared.

The consultant for this project is Hawaii Pacific Engineers, Inc., working for the Department of Wastewater Management, City and County of Honolulu. Public comment will be solicited throughout the facilities plan process.

The facility plan process started in January 1996 and is anticipated to be complete by December 1997.

MEETING ATTENDANCE

PROJECT: WAIMANALO FACILITIES PLAN AND EIS
 MEETING: MEETING WITH CITIZEN ADVISORY GROUP DATE: 3/16/96
 LOCATION: WAIMANALO PUBLIC LIBRARY TIME: 9:00 am

#	NAME (PLEASE PRINT)	AGENCY/GROUP	PHONE NO.
1	Bob Saleser	ANA INST	
2	Nancy Glover	Resident: Puna	
3	Bob Kenna	Resident	
4	Mike Kendall	RESIDENT	
5	Two J. Anderson	Representative	
6	Gregory Field	13,100,100: Nerlbert LLC	
7	Linda Akana	resident	
8	Tom Yuen	KWM	
9	Max Smith	HPE	
10	Ken ABE	HPE	
11			
12			
13			
14			
15			
16			
17			
18			
19			
20			
21			

City and County of Honolulu
Department of Wastewater Management

AGENDA FOR MEETING WITH CITIZEN ADVISORY GROUP
ON WAIMANALO WASTEWATER FACILITIES PLAN

- DATE/TIME:** OCTOBER 19, 1996, 9:00 AM
- LOCATION:** WAIMANALO PUBLIC LIBRARY
- PURPOSE:** The general purpose is to obtain citizen input on the Waimanalo Wastewater Facilities Plan currently being prepared by the City Department of Wastewater Management and Hawaii Pacific Engineers, Inc.
- The primary objective of this meeting will be to discuss the consultant's findings to date and obtain input from key community members on pertinent issues.
- MEETING AGENDA**
- I. Introductions
 - II. Discuss scope of meeting and distribute fact sheet
 - III. Discuss wastewater flow projections
 - A. Land use projections
 - B. Population projections
 - C. Wastewater flows, including wet weather peaking factors
 - IV. Discuss wastewater collection system expansion and improvements
 - A. Survey results and ongoing groundwater quality studies for Beach Lot and Bell Street areas
 - B. Other areas
 - C. Rehabilitation of "leaky" sewers
 - V. Discuss improvements and modifications to the wastewater treatment plant facilities
 - A. Centralized treatment versus decentralized wastewater facilities
 - B. Effluent disposal by effluent reuse (State Ag Park, Olomana Golf Course), injection wells, and other means
 - C. Existing wastewater treatment facility limitations/problems and short/long term improvements to facilities
 - VI. Wastewater infrastructure improvement costs and financing
 - VII. Set date and discuss agenda for public information meeting
 - VIII. Other discussion items (time permitting)

Waimanalo Wastewater Facilities Background Information Summary

Prepared by Hawaii Pacific Engineers, Inc. for the
Waimanalo Wastewater Facilities Plan Project
October 18, 1996

WAIMANALO WASTEWATER COLLECTION SYSTEM

Residential	Population	Homes
Estimated total existing population/homes	9,400	2,110
Estimated existing population/homes in sewered areas	6,050	1,210
Estimated existing population/homes actually connected to sewers	5,050	1,010
Estimated population and new homes approved for connection to sewers (DHHL Waimanalo Residence Lots Unit IX)	212	53
Estimated population and homes in unsewered areas projected to be sewered (Beach lots and Bell St. areas)	1,800	450
Estimated future additional population and new sewered homes projected by year 2020 (worst case scenario)	5,120	1,320
Estimated total population and homes on sewers by year 2020 (worst case scenario)	12,010	3,040

Equivalent Population*

- Non-Residential (schools, stores, restaurants, etc.)
- Estimated equivalent population for existing non-residential population serviced by sewers 1,240
 - Estimated equivalent population for future additional non-residential population serviced by sewers 520
 - Estimated total non-residential equivalent population projected on sewers by year 2020 1,760

*Equivalent population refers to the "equivalent" residential population that would generate a comparable wastewater flow.

WAIMANALO WASTEWATER TREATMENT PLANT (WWTP)

General

The Waimanalo WWTP was constructed in 1969 and began operation in 1972. The treatment plant facilities are owned by the State Department of Land and Natural Resources (DLNR). The plant is operated by the City and County of Honolulu Department of Wastewater Management (DWWWM). The plant was originally rated for an average flow of 1.1 million gallons per day (MGD) but was subsequently downrated based on the 1984 Facilities Plan to 0.7 MGD due to process limitations. A 1993 UIC injection well permit specified an incorrect 0.504 MGD permitted capacity that was later corrected.

Flows

Existing plant flows (based on January to August, 1996)
Average flow 0.62 MGD
Highest monthly average 0.68 MGD

Waimanalo Wastewater Facilities Background Information Summary (continued)

Flows (continued)

Existing plant flows (based on January to August, 1996)
 Lowest monthly average 0.57 MGD
 Highest daily flow 1.37 MGD
 City/Department of Health average flow "design capacity" 0.70 MGD
 Highest recorded peak wet weather effluent flow (1991 to 1996) 3.7 MGD
 Estimated extreme peak wet weather flow 6.1 MGD

Effluent Disposal

Method: Injection wells
 Number: Seven (three older original wells and three new wells constructed in 1995 are in operation; one original well is collapsed and not functional)
 Depths: Approximately 200 to 220 feet deep. The wells are provided with solid casing and cement grout to depths of approximately 70 to 108 feet.
 Capacity: Based on well capacity testing in 1994, the total capacity of the six operational wells was determined to be 10.77 MGD (9.06 MGD for three new wells and 1.71 MGD for three original wells). Note: The test results reflect "clean" water testing and the initial "unclogged" capacity of the new wells before they were placed in operation. The existing capacity of the wells are unknown since flow metering equipment is not currently operational.

Liquid Stream Treatment Process

The Waimanalo WWTP utilizes the "Rapid Bloc" activated sludge process to provide secondary biological treatment. Effluent quality for 1996 based on 24-hour composite compliance monitoring data is as follows:

	Jan	Feb	Mar	Apr	May	Jun	Jul	Aug
BOD, mg/l	44	19	11	26	18	32	17	9
TSS, mg/l	22	6	7	12	10	13	5	3

(BOD refers to 5-day Biochemical Oxygen Demand; TSS refers to Total Suspended Solids)

The treatment facility is presently having difficulty in meeting the effluent standards (30 mg/l BOD and TSS monthly average) on a consistent basis due to limitations of the outdated treatment process. The downrated 0.7 MGD capacity of the treatment facility based on the findings of the 1984 Facilities Plan appears justified based on current operating data.

Based on plant records, an average of 6,400 gallons per day (3.3 loads per day) of cesspool wastes were discharged by City cesspool pumping trucks between January 1994 and August 1996. The highest recorded volume in a single day was 22,000 gallons.

Waimanalo Wastewater Facilities Background Information Summary (continued)

Solids Stream Treatment and Disposal Process

The sludge generated by the treatment process is designed to be stabilized by the anaerobic digestion facilities, dewatered by sand drying beds, and disposed of at a sanitary landfill. Currently, sludge is being hauled three times per week to the Kailua WWTP for treatment and disposal.

Current Status of Proposed Plant Improvements

R.M. Towill Corporation is being contracted by the DLNR to design effluent filters, a UV disinfection system and improvements to the injection well backwash system. Belt Collins Hawaii is currently under contract by the City and County of Honolulu Department of Wastewater Management to design equalization facilities and a dissolved air flotation (DAF) sludge thickener.

Preliminary recommendations of the current facilities plan proposes future expansion of the plant to an average design flow of 1.4 MGD to accommodate future sewer connections.

Summary Review of Recent Department of Health (DOH) Operation and Maintenance Inspection Reports

1996: Conditional Acceptance. DOH noted the deteriorated primary digester cover, staffing shortage, the exceedance of BOD and TSS effluent limitations in November of 1995 (blower failure), and spillage problems with the injection well backwash system. DWWWM responded by stating that the digester cover replacement is scheduled for completion by September 1997, staffing shortage was alleviated with addition of two operators, a new backup blower is to be installed, and DLNR is in the process of discussing well cleaning procedures with DOH. DWWWM reported that the DLNR project for a DAF thickener, effluent sand filter, and/or ultraviolet disinfection system are "on hold" pending the recommendations of the new facilities plan.

1995: Conditional Acceptance. DOH noted the exceedance of BOD and TSS effluent limitations in January, March and November of 1994, and spillage problems with the injection well backwash system. Effluent limitation exceedances were addressed by DWWWM by increasing staff to provided better in-plant monitoring during peak flows. DOH recommended the installation of an equalization basin. The DWWWM modified the influent pumping system and operations to allow the pump station wetwell, sewer lines and standby primary clarifier tank to provide equalization. The need for an equalization basin will be further investigated by the DWWWM.

1994: Conditional Acceptance. DOH noted overflow of effluent from the injection wells and exceedance of BOD and TSS effluent limitations in January, February, June and July of 1993. The report noted that construction of new injection wells should resolve overflow problems and effluent violations should no longer be a major problem due to elimination of the process waste stream from the UH fruit-fly facility.

MEETING ATTENDANCE

PROJECT: WAIMANALO FACILITIES PLAN AND EIS

MEETING: CITIZEN ADVISORY GROUP

DATE: 10/19/96

LOCATION: WAIMANALO PUBLIC LIBRARY

TIME: 9:00 am

#	NAME (PLEASE PRINT)	ORGANIZATION	PHONE NO.
1	MICHAEL KENDALL	PSG. INC.	
2	Bill Young	HOME OWNER	
3	Nancy Jones	Neighborhood Council	
4	Aly El-Fadi	Univ. of Hawaii	
5	LISA FERRELL	Home Owner	
6	GREGORY FIED	W. Neighborhood Bell NEWS	
7	Bill Liu	DWM Long Range Planning	
8	Jesse Yuen	WWM Service Control	
9	Steve Ching	" Planning	
10	Mac Smith	HPE	
11	Sam F. ...	P.O. ...	
12	Roy Abe	HPE	
13			
14			
15			
16			
17			
18			
19			
20			
21			
22			

City and County of Honolulu
 Department of Wastewater Management
**PUBLIC INFORMATION MEETING FOR
 WAIMANALO WASTEWATER FACILITIES PLAN**

DATE/TIME: July 30, 1997, 7:00 PM
LOCATION: Waimanalo Public Library
PURPOSE: The purpose of the meeting is to discuss the findings and recommendations presented in the Waimanalo Wastewater Facilities Plan (prefinal draft) prepared by the City Department of Wastewater Management and Hawaii Pacific Engineers, Inc.
 The meeting is intended to solicit input from community members on water quality issues and the proposed recommendations for wastewater infrastructure improvements.

MEETING AGENDA

- I. Introductions
- II. Purpose and Scope of the Project
- III. Wastewater Facility Plan Findings and Recommendations
 - A. Water quality and wastewater management issues
 - B. Future development and population projections
 - C. Individual wastewater systems (cesspools)
 - D. Wastewater collection system
 - E. Waimanalo Wastewater Treatment Plant
 - F. Cost and financing of improvements
- IV. Other Discussion Items (time permitting)

MEETING ATTENDANCE

PROJECT: WAIMANALO FACILITIES PLAN AND EIS
MEETING: PUBLIC INFORMATION MEETING
LOCATION: WAIMANALO PUBLIC LIBRARY
DATE: 7/30/97
TIME: 7:00 pm

#	NAME (PLEASE PRINT)	ORGANIZATION	PHONE NO.
1	Steve Ching	Wastewater Mgmt	
2	KEVIN SIDI MUMBER	LA SHEL JAIL	
3	Deqa K. Mirekomi	Wastewater Mgmt	
4	DIM ANDREWS	HPE	
5	JOE RYAN	Hilak Ranch	
6	CARL ARAKAKI	WWM	
7	BILL LIU	"	
8	KENNY GODDENOW	Legis lafore	
9	GREGORY FIELD	WAIMANALO NEWS	
10	ERNEST K. MAKAIKI	WWM	
11	ROY AGE	Hawai Pacific Engineers	
12			
13			
14			
15			
16			
17			
18			
19			
20			
21			
22			

MEETING ATTENDANCE

PROJECT: WAIMANALO FACILITIES PLAN AND EIS

MEETING: PUBLIC INFORMATION MEETING

DATE: 7/30/97

LOCATION: WAIMANALO PUBLIC LIBRARY

TIME: 7:00 pm

#	NAME (PLEASE PRINT)	ORGANIZATION
1	QUENTIN McKENNA	
2	Walter Hartman	City & County - Waimanalo
3	BOB SPATTO	P.M. TOSHIKI COOP
4	DOUGLAS INAMATO	P.M. TOSHIKI COOP
5	Andy Chen	Waimanalo - Waimanalo
6	DANIEL BOUVER	UH/OCEANOGRAPHY
7	DENISE WONG	COH
8	MAC SMITH	HAWAII PACIFIC ENGINEERS
9	DAVE LARSON	RESIDENT WAIMANALO
10	Halley Kawalewa	RESIDENT WAIMANALO
11		
12		
13		
14		
15		
16		
17		
18		
19		
20		
21		
22		

Public Hearing

A public hearing was held on August 25, 1998 at the Waimanalo Public and School Library. The public was notified of the hearing in the cover letter for the distribution of the DSEIS and through a legal advertisement in the Honolulu Star Bulletin and The Honolulu Advertiser. An attempt was also made to notify the public through the Waimanalo News. Due to a delay in the publication of the paper, however, the hearing information was not published before the meeting date.

Despite the notification of the public, no residents from Waimanalo attended the public hearing. The meeting was attended by members of the City's Department of Design and Construction and Department of Environmental Services, the project prime consultant (Hawaii Pacific Engineers), and a project subconsultant (Dr. Aly El-Kadi of the University of Hawaii Water Resources Research Center). Since those in attendance were already familiar with the project, Mr. Timothy Steinberger, the hearings officer, conducted an abbreviated meeting which primarily involved the answering of questions posed by Dr. El-Kadi.

The meeting legal notice, agenda and handout material, attendance list, and transcript of the meeting are presented in the pages which follow.

**NOTICE OF PUBLIC HEARING
AND AVAILABILITY OF DRAFT
SUPPLEMENTAL ENVIRONMENTAL
IMPACT STATEMENT**

The City and County of Honolulu Department of Design and Construction (formerly Department of Wastewater Management) is updating its Waimanalo Wastewater Facilities Plan. This planning document describes recommended sewer system and treatment facility improvements to meet the wastewater management needs of the Waimanalo community to the year 2020. Proposed major improvements include the construction of additional treatment facilities at the Waimanalo Wastewater Treatment Plant and rehabilitation of existing sewers. The plan envisions future reuse of treated effluent through agricultural and landscape irrigation. Sewering of additional existing homes in the coastal area of Waimanalo to eliminate use of individual wastewater systems is recommended if future studies indicate that this action will result in water quality benefits. The total estimated capital cost for the proposed wastewater facility improvements is \$22.8 million.

Notice is hereby given that the Draft Supplemental Environmental Impact Statement (DSEIS) for the Waimanalo Wastewater Facilities Plan has been distributed and is available for review and comments. To ensure that all significant issues are identified and the full range of issues related to this project are addressed, comments and suggestions are invited from all interested parties. If you wish to comment, please mail or deliver any comments you may have to the following:

Mr. Randall K. Fujiki, Director
City and County of Honolulu
Department of Design and Construction
650 South King Street, 2nd Floor
Honolulu, Hawaii 96813

Copies of the DSEIS are available for public inspection at the following public libraries:

Hawaii State Library
478 South King Street
Honolulu, Hawaii

Kaneohe Regional Library
45-829 Kamehameha Hwy.
Kaneohe, Hawaii

Waimanalo Public & School Library
41-1320 Kalaniana'ole Highway
Waimanalo, Hawaii

Notice is also hereby given that the City and County of Honolulu Department of Design and Construction will hold a Public Hearing on the proposed wastewater facility improvements on August 25, 1998 at 7:00 p.m. at the Waimanalo Public and School Library. The purpose of the Public Hearing is to present the major findings and conclusions of the Waimanalo Wastewater Facilities Plan project, answer questions, and solicit written or oral testimony from those who have an interest in the project. Oral testimony will be transcribed verbatim for the record. The public is invited to attend. Persons unable to attend or desiring not to present oral testimony at the Public Hearing may file signed statements presenting their views on any aspect of the proposed actions. To be considered, such statements and/or written comments must be received by mail, or otherwise delivered to the address listed above for comments by September 22, 1998.

(Hon. S.-B.: Aug. 20, 1998)

(SB-1687)



City and County of Honolulu
Department of Planning and Construction

**PUBLIC HEARING FOR
WAIMANALO WASTEWATER FACILITIES PLAN
DRAFT SUPPLEMENTAL ENVIRONMENTAL IMPACT STATEMENT**

DATE/TIME: August 25, 1998, 7:00 PM

LOCATION: Waimanalo Public Library

PURPOSE: The purpose of the meeting is to present the major findings and conclusions of the Waimanalo Wastewater Facilities Plan and the Draft Supplemental Environmental Impact Statement prepared for the project.

The meeting is intended to solicit input and answer questions from community members on water quality issues and the proposed recommendations for wastewater infrastructure improvements.

MEETING AGENDA

- I. Introductions
- II. Purpose and Scope of the Project
- III. Wastewater Facilities Plan Findings and Recommendations
 - A. Water quality issues
 - B. Future development and population growth
 - C. Individual wastewater systems (cesspools)
 - D. Wastewater collection system
 - E. Waimanalo Wastewater Treatment Plant
 - F. Cost and financing of improvements
- IV. Public Testimony
- V. Questions/Comments/Open Discussion

**PUBLIC HEARING FOR
WAIMANALO WASTEWATER FACILITIES PLAN
August 25, 1998**

SUMMARY OF FINDINGS AND RECOMMENDATIONS

A. WATER QUALITY ISSUES

- Water quality data indicate that bacteriological water quality of Waimanalo's coastal waters is generally in compliance with water quality standards. Under wet weather conditions, the water quality of the nearshore waters appears to be degraded by the effects of point and nonpoint sources of pollution discharging to Waimanalo Stream and Inoaole Stream.
- High nutrient loading, primarily nitrogen in the form of nitrates, and the associated occurrence of periodic algal blooms in Waimanalo's coastal waters are of concern. The algal blooms appear to be associated with wet weather conditions and nonpoint sources of pollution. Nitrogen from individual wastewater systems, particularly in the low lying coastal areas, may be a contributing factor.
- The Waimanalo Wastewater Treatment Plant (WWTP) does not appear to be a major contributor of water quality problems in Waimanalo. A layer of low permeability alluvial sediments minimizes the tendency of treated effluent discharged into subsurface injection wells to surface in near shore areas.

B. FUTURE DEVELOPMENT AND POPULATION GROWTH

- The Waimanalo planning area's 1997 population was estimated to be approximately 9,400. It is estimated that approximately 6,100 residents, or about 65 percent of the total population, currently reside in areas serviced by the centralized wastewater collection and treatment system.
- The projected year 2020 total residential population is 11,400. The projected residential sewer service area population is 9,300, which represents an increase of approximately 50 percent over existing conditions. The service area population is projected to grow primarily due to anticipated land development by the Department of Hawaiian Home Lands and expansion of the wastewater collection system to service existing unsewered dwellings.

C. INDIVIDUAL WASTEWATER SYSTEMS

- Individual wastewater systems serve the unsewered areas of Waimanalo. These systems include cesspools, septic tank systems and aerobic treatment systems.
- The City's Department of Environmental Services cesspool pumping records show that 71 cesspools (6.4 percent) of the estimated 1,105 individual wastewater systems required pumping at least once in 1995. Cesspool failures can be attributed to location of the cesspools in low permeability soils, clogged infiltrative surfaces, high groundwater conditions, adverse weather conditions, and overloading due to large household sizes.

C. INDIVIDUAL WASTEWATER SYSTEMS (continued)

- Potential public health impacts from contamination of recreational waters in Waimanalo by microbiological contaminants from subsurface leachates of individual wastewater systems appear to be relatively insignificant. Groundwater investigations and literature information indicate that pathogens in the leachates are likely to be effectively removed within the sandy soil in the coastal areas.
- Based on the results of groundwater investigations in Waimanalo, the discharge of soluble nitrates from individual wastewater systems into nearshore coastal waters is the primary concern. It is recommended that additional investigations be conducted to better identify the sources, quantities and fate of nitrogen compounds generated from various activities and land uses within the Waimanalo watershed.
- A survey conducted as part of this study indicated that 54 percent of residents in the unsewered coastal areas favor retaining individual wastewater systems even if the systems were found to be a cause of coastal water quality problems. In comparison, 76 percent of the responses favored retaining their individual wastewater systems if the systems were found to not be a cause of coastal water quality problems.

D. WASTEWATER COLLECTION SYSTEM

- The existing main trunk sewers in the Waimanalo wastewater collection system appear to generally be in satisfactory condition based on a review of available video camera inspection data.
- The existing gravity trunk sewers on the eastern portion of the system have adequate capacity to handle existing and future (year 2020) peak wet weather flows.
- On the western side of the system, the capacity of the existing trunk sewer may be exceeded during heavy rainfall under existing conditions. It is recommended that corrective and sewer rehabilitation work be performed to reduce excessive rainwater inflow into the sewer system and meet future flow capacity requirements.
- It is recommended that the sewerage of approximately 350 homes in the beach lot area (Sewer Improvement District Section 2) be deferred until the impacts of the individual wastewater systems on coastal water quality relative to other pollution sources can be substantiated and better quantified.
- It is recommended that the approximately 100 homes in the Bell Street area (Sewer Improvement District Sections 3 and 5) not be sewerage due to the very high (\$60,000) cost per home for sewerage this area and the marginal anticipated benefits to public health and coastal water quality.

E. WAIMANALO WASTEWATER TREATMENT PLANT

- The existing Waimanalo Wastewater Treatment Plant (WWTP) has a rated average design capacity of 0.7 million gallons per day (mgd) and a current average flow of approximately 0.6 mgd.
- The Waimanalo WWTP periodically experiences unstable performance which can result in periodic effluent quality violations. Treated effluent is disposed of through the use of subsurface injection wells. The existing capacity of the disposal wells is marginal due to clogging of the wells from excessive suspended solids in the effluent. These problems can be attributed to increases in the service area population and loadings on the plant, high wet weather flows, and the use of outdated liquid stream treatment technology.
- Extensive improvements are proposed for the Waimanalo WWTP to increase its average design capacity to 1.1 mgd to accommodate the projected year 2020 wastewater flows and provide a satisfactory degree of performance reliability.
- Major proposed liquid stream improvements include a new secondary biological treatment process, an effluent filtration system, and additional injection wells. Other proposed liquid stream improvements to allow production of reclaimed water for irrigation reuse include an ultraviolet disinfection system and effluent pumping facilities. Reclaimed water is targeted for use at selected farm lot sites and the Olomana Golf Links.

F. COST AND FINANCING OF IMPROVEMENTS

- The total estimated cost for all the proposed improvements is \$22.8 million. Sewerage of the beach lot area is estimated to cost \$6.7 million. The improvements at the Waimanalo WWTP are estimated to cost \$16.1 million.
- The Waimanalo WWTP is owned by the State and operated by the City. It is anticipated that the State will be funding the majority of the treatment plant improvements and that ownership of the plant will be transferred to the City in the future. The schedule for the plant upgrade work is dependent on securing funds from the State legislature.
- The City is anticipated to fund the sewers in the beach lot area and rehabilitation of the existing sewer system.

DATE 01/03/98 PA US
 SCALE 1" = 4000' OMR 1/24/98
 JLT 0524-00 REVISED 07/23/98

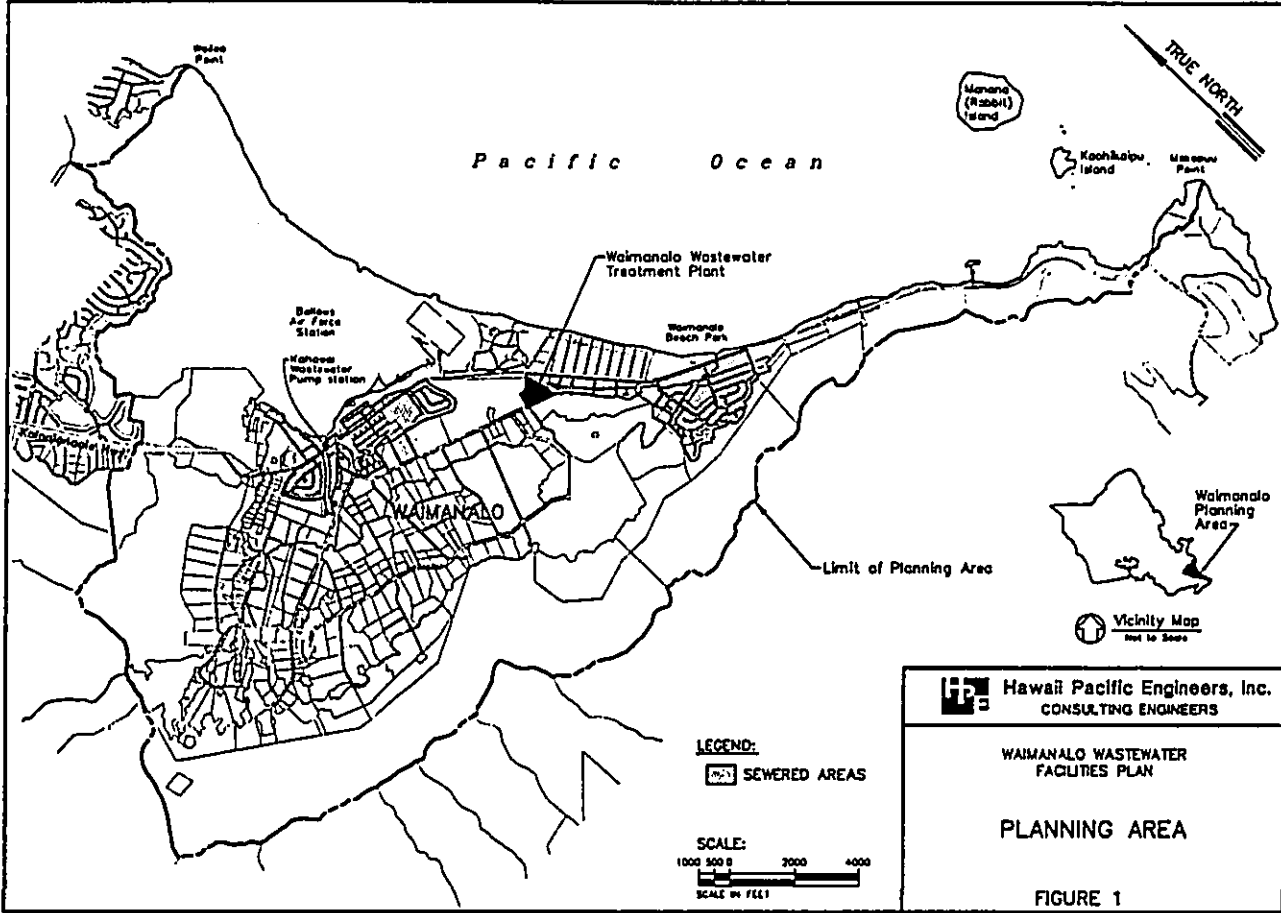

RECOMMENDED IMPLEMENTATION PRIORITY LIST

Priority	Action	Budget Cost	Rationale and Comments
High	Construct effluent filter system.	\$1,870,000	Improves plant performance and reduces potential injection well clogging problems. Construction to be completed in 1999.
High	Clean existing injection wells. Construct additional injection wells as required.	\$1,150,000 (3 new wells)	Minimizes potential for spills during high wet weather flows. Number of new wells to be determined based on the effectiveness of the well cleaning work and well capacity tests.
High	Investigate infiltration and inflow problems in western portion of the collection system and rehabilitate sewers as required.	\$650,000	Reduces the magnitude of peak flow which minimizes the potential for spills and improve treatment plant performance. Reduces need and cost for capital improvements to accommodate high peak flows.
High	Construct new anoxic-aerobic biological nutrient removal treatment units, final clarifiers and other related improvements. Construct sludge thickening facilities.	\$7,150,000	Increases plant performance, stability and capacity. Permits future planned developments to proceed and existing dwellings serviceable by sewers to connect. Reduces nitrate loading on coastal waters.
Moderate	Institute other treatment plant upgrade work such as seepage receiving station, influent monitoring facilities, additional influent pump, sludge bed improvements, fire protection upgrade, flood protection, and support facilities.	\$4,150,000	Facilitates operation of treatment facilities and improves personnel safety and morale.
Moderate	Construct additional facilities to permit irrigation reuse of effluent, including chemical feed facilities, ultraviolet disinfection system and effluent pump station.	\$1,820,000	Permits reuse of effluent to conserve water resources, and reduces hydraulic loading on injection wells and nutrient loading on nearshore waters.
Moderate	Perform further investigations on impact of subsurface wastewater discharges on coastal waters and relative impact of other nutrient sources in Waimanalo.	\$150,000	Potential savings of \$5.8 million in sewer capital improvement costs. Potential funding available through the Kaula Bay Advisory Council.
Moderate to Low	Install variable frequency drives and new fire hydrant at the Kahawai Stream Wastewater Pump Station.	\$250,000	Increases energy efficiency and reliability, and improves the level of fire protection.
Moderate to Low	Implement beach for area Sewer Improvement District No. 2 (if further studies recommended above indicate water quality benefits will be realized)	\$5,760,000	Reduces nitrate and other pollutant loading on nearshore waters. Eliminates public health concerns with malfunctioning individual wastewater systems.

DATE 01/05/96 PM US
 SCALE 1" = 1200' OPEB SAA
 FILE 0520-07 REVISED 4/10/96

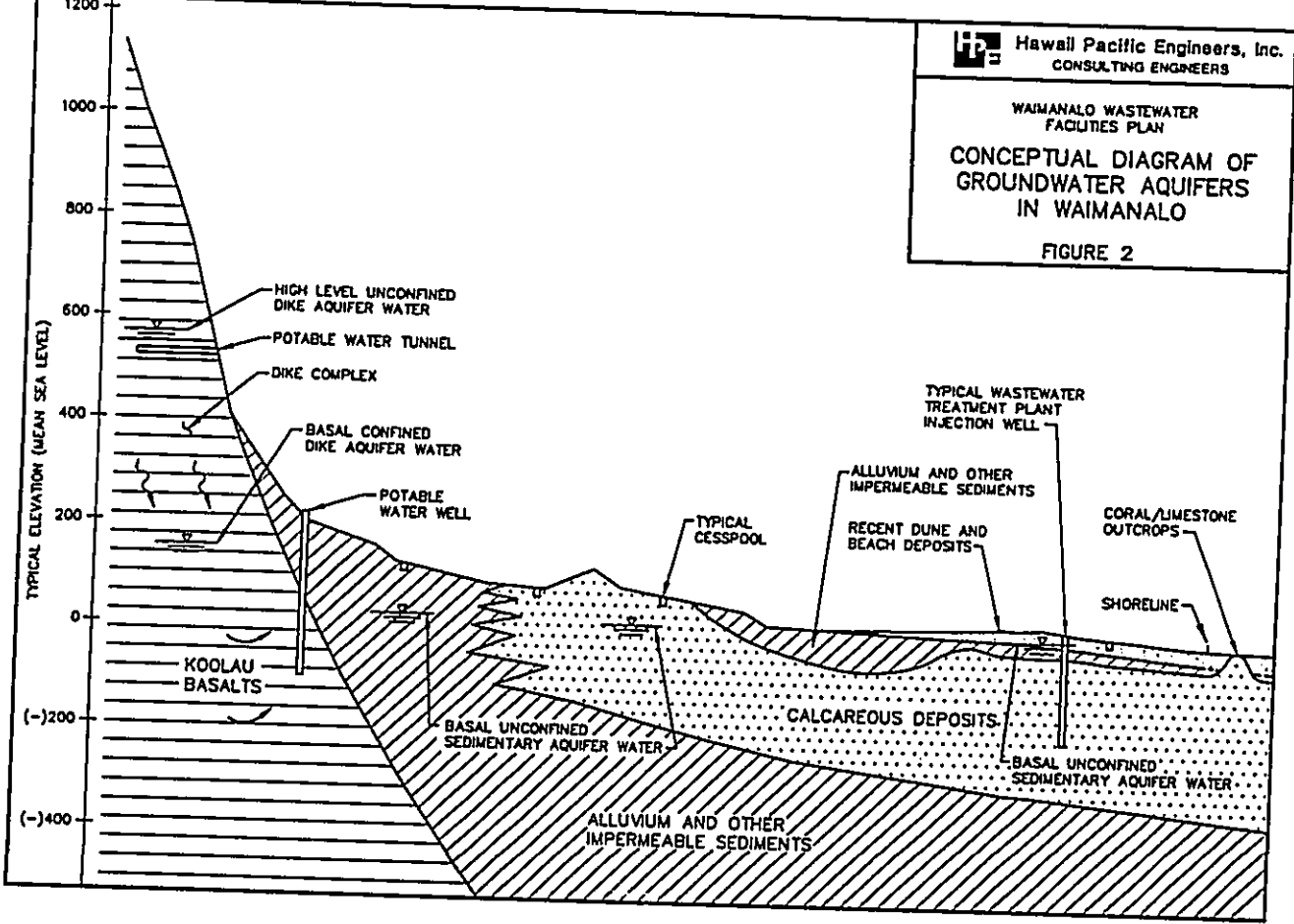

DATE 01/05/96 PM US
 SCALE 1" = 1200' OPEB SAA
 FILE 0520-07 REVISED 1/13/96

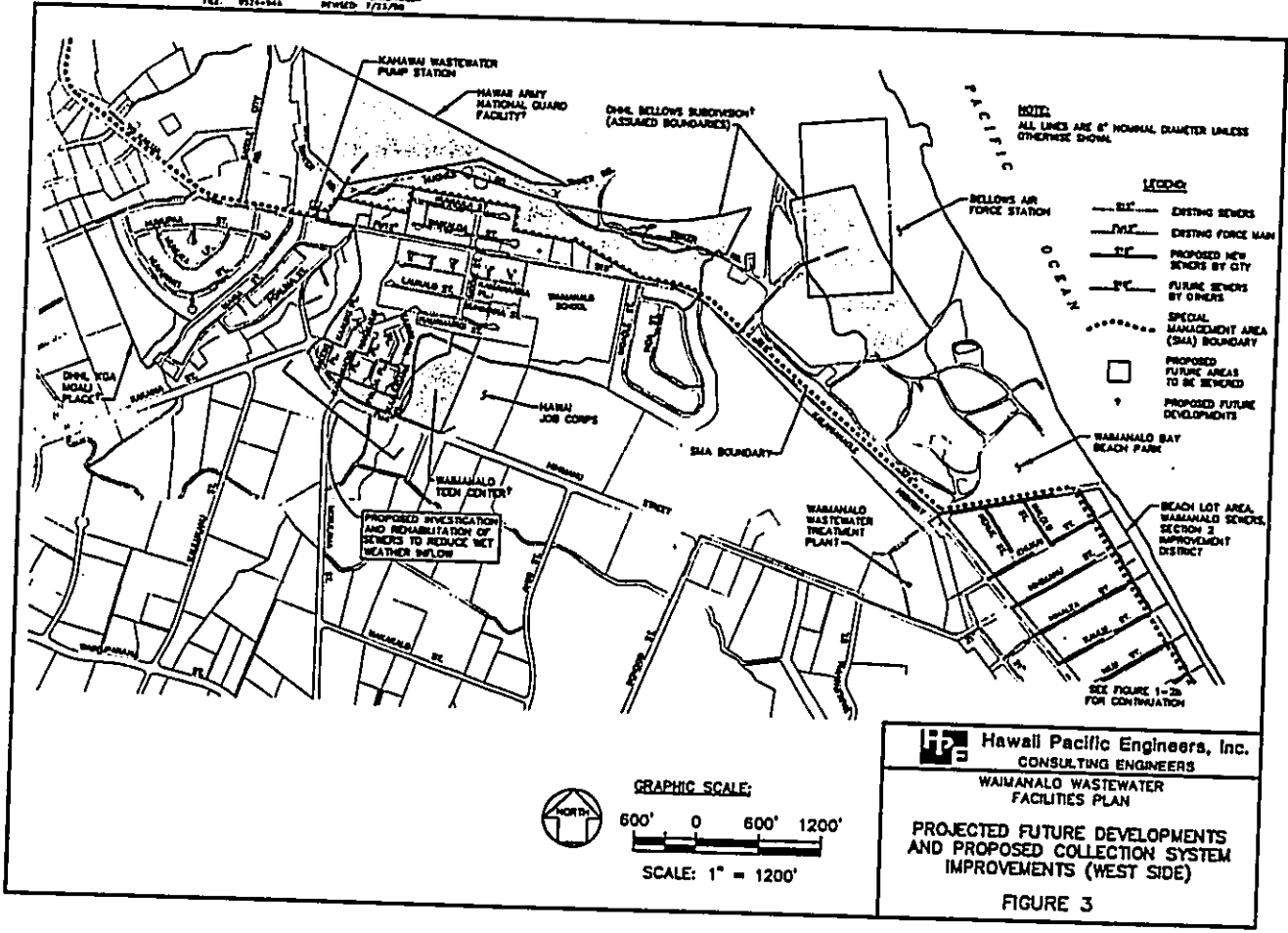

DATE: 01/21/98
 SCALE: 1" = 1200'
 FILE: 9321-034

PL: MS
 DPER: SHS
 REVISED: 7/23/98

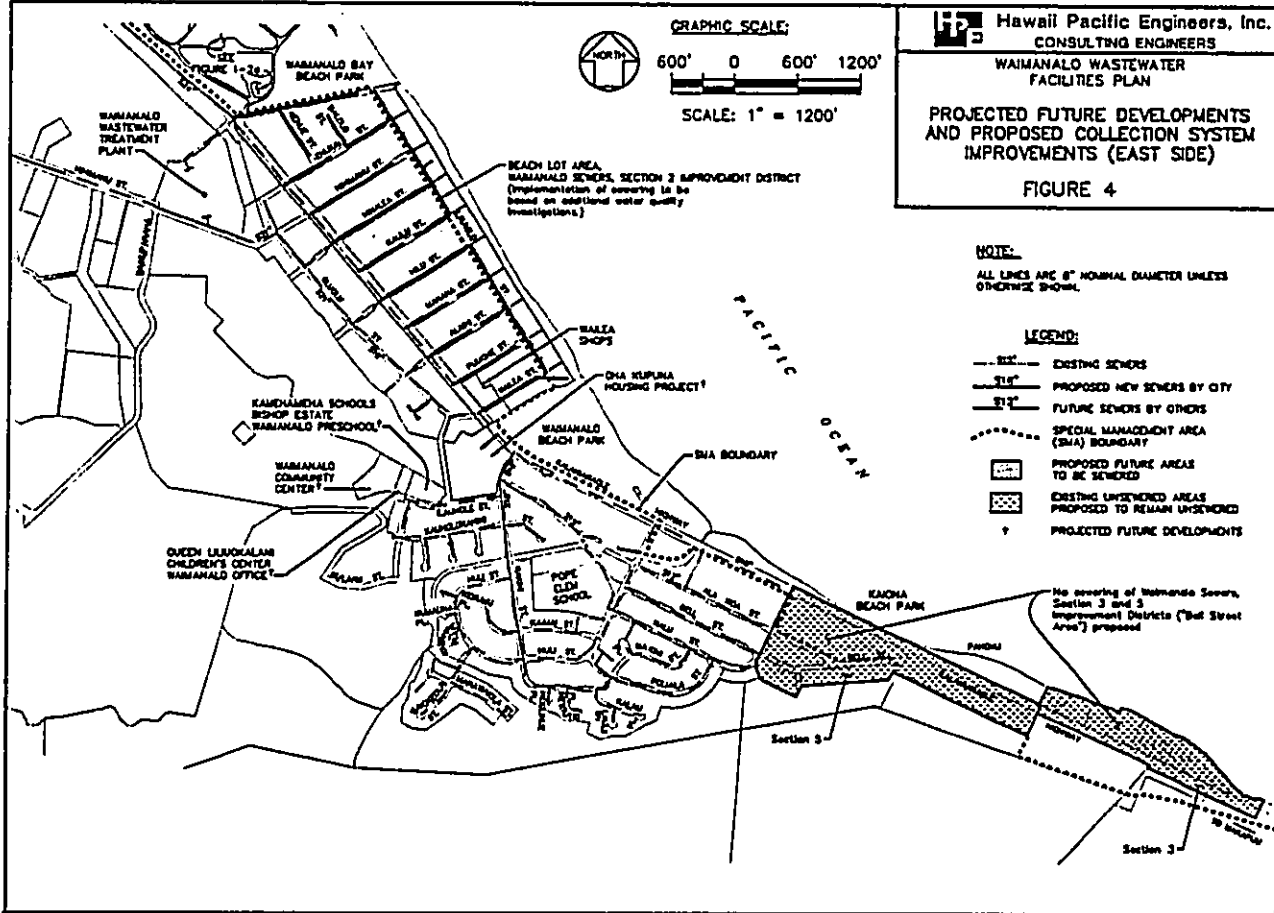

DATE: 01/05/98
 SCALE: 1" = 150'
 FILE: 9321-074

PL: MS
 DPER: SHS
 REVISED: 8/29/98

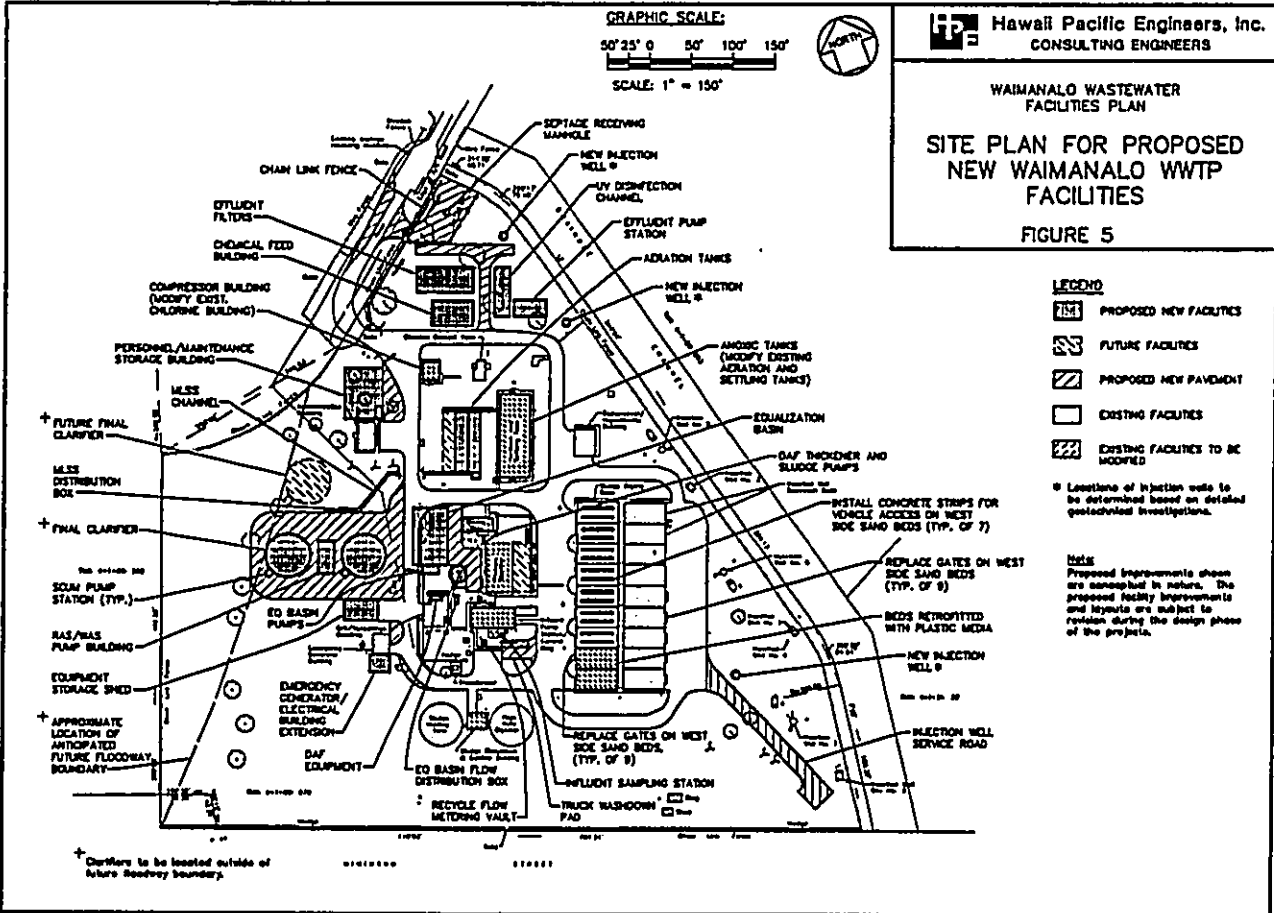

MEETING ATTENDANCE

PROJECT: WAIMANALO WASTEWATER FACILITIES PLAN AND EIS

MEETING: PUBLIC HEARING

DATE: August 25, 1998

LOCATION: WAIMANALO PUBLIC LIBRARY

TIME: 7:00 p.m.

	NAME (PLEASE PRINT)	ORGANIZATION	PHONE NO.
1	Aly El-Radi	Water Resources Research, Inc.	956-6333
2	Carl Arakawa	DE & C (C-221, 13m)	523-4671
3	Ivan Hawkins	DENV - WTD	254-4152
4	Tim Steiberger	D DC - Planning	527-5380
5	Donny Wong	ENV - CCH	527-5136
6	Roy Abe	Hawaii Pacific Engineers	524-3771
7			
8			
9			
10			
11			
12			
13			
14			
15			
16			
17			
18			
19			
20			
21			
22			
23			
24			
25			

ORIGINAL

WAIMANALO WASTEWATER FACILITIES PLAN

PUBLIC HEARING

Tuesday, August 25, 1998
 Waimanalo Public Library
 Waimanalo, Hawaii
 7:00 p.m.

Recorded By:

Bruce Getman

POWERS & ASSOCIATES
 (808) 536-2001

PROCEEDINGS

1 MR. STEINBERGER: Good Evening, my name
 2 is Tim Steinberger. I'm with the Division of
 3 Planning and Programming with the City
 4 Department of Design and Construction. And
 5 this evening I am the hearings officer. We'd
 6 like to thank everybody who's here for
 7 attending this public hearing on the Waimanalo
 8 Wastewater Facilities Plan and EIS.
 9 This project was previously under the
 10 Department of Waste Water Management, but due
 11 to the recent city reorganization this project
 12 and the personnel associated with the project
 13 have been transferred now to this department
 14 of Design and Construction. The Department of
 15 Wastewater Management is now known as the
 16 Department of Environmental Services and
 17 personnel from this Department are also
 18 involved in this project.

19 Other members present tonight form the
 20 City and County; Denise Wong with the Division
 21 of Environmental Quality, is with the
 22 Department of Environmental Services. The
 23 project engineer; Carl Arakaki, who's with the
 24 Division of Planning and Programming. Ivan
 25

POWERS & ASSOCIATES
 (808) 536-2001

1 Hawkins, who's with the Department of
 2 Environmental Services Treatment and Disposal
 3 and the consultant, Roy Abe, with Hawaii
 4 Pacific Engineers.

5 The purpose of the Waimanalo Wastewater
 6 Facilities Plan project is to analyze and
 7 recommend future sewer system and waste water
 8 treatment facility improvements for the
 9 Waimanalo community. The planning time frame
 10 spans from present to the year 2020. Tonight
 11 the project's consultant, Hawaii Pacific
 12 Engineers, is here to go over their findings,
 13 solicit any input and answer any questions.
 14 The environmental impact statement has been
 15 prepared in the draft form and we are
 16 soliciting comments on the facilities plan and
 17 the EIS.

18 The Waimanalo Wastewater Treatment Plant
 19 is an unusual facility in that the plant is
 20 owned by the State and operated by the City.
 21 The City, in the interest of the community,
 22 has taken on the task of forming the long
 23 range planning work for the system.

24 This is the fifth meeting with the
 25 Waimanalo community on this project. Based on

POWERS & ASSOCIATES
 (808) 536-2001

1 Yourself?
 2 DR. EL-KADI: My name is Dr. El-Kadi. I'm
 3 with the University of Hawaii. And a long
 4 time Associate. My question is about the
 5 wastewater treatment plant. As it says here,
 6 sewage is injected in the deep wells and it's
 7 not likely to come up to the shallow layer.
 8 But it has to come up somewhere so I ask you
 9 does it come to the ocean floor somewhere do
 10 we look at it (inaudible)?

11 MR. ABE: I'd like to answer that question
 12 by referring to Figure 2 in your handout.
 13 Figure 2 shows a typical cross section of
 14 Waimanalo. The injection wells for the plant
 15 inject the treated effluent, between 100 and
 16 200 feet below the ground surface. Based on
 17 the geology, there's a impermeable layer
 18 between the upper sandy soil and the lower
 19 coral stratum. The waste water is being
 20 injected into the coral stratum. So although
 21 the wastewater would have a tendency to rise,
 22 this impermeable layer, we feel, keeps it from
 23 surfacing at least not near the shoreline. It
 24 will tend to move further out to the ocean.
 25 There are some coral outcrops where the waste

1 input at previous meetings, two issues that
 2 the Waimanalo community were very concerned
 3 with were the need to sewer homes in the
 4 coastal areas to protect water quality, and the
 5 capacity and performance of the Waimanalo
 6 Waste Water Treatment Plant and it's sub-
 7 surface injection wells.

8 The consultant has spent considerable
 9 amount of effort to address these issues.
 10 This is a formal public hearing and tonight we
 11 have a stenographer to record the proceedings.
 12 If you are interested in providing oral
 13 testimony please sign up at the sheet
 14 provided. There is a comment and question
 15 sheet on the back of the handout that is
 16 available at the desk and can be turned in
 17 tonight or sent in to the City.

18 Given the sparse nature of the audience,
 19 I'd like to turn the podium over to Roy Abe to
 20 answer any questions that may come up from the
 21 audience.

22 MR. ABE: Do we have any questions from
 23 the audience?

24 DR. EL-KADI: Yes, I do.

25 MR. ABE: Dr. El-Kadi. Can you introduce

1 water could surface to the ocean; however, the
 2 wastewater would be very dilute. And also
 3 again, the waste water is treated and
 4 disinfected. Nutrients are somewhat of a
 5 concern. However, we feel that most of the
 6 wastewater enters the ocean fairly far out to
 7 sea and it's well diluted. But it is
 8 something that should be looked at further.

9 One of the things that will help the
 10 situation are the new plant improvements. We
 11 intend to incorporate a nitrogen removal
 12 process which will remove a substantial
 13 portion of the nitrogen from the effluent and
 14 this will reduce the impacts on water quality.
 15 And also again, the effluent is disinfected,
 16 so we don't feel that bacteriological
 17 contaminants are a major concern.

18 DO: There is also the question about the
 19 cost? The list items is that the City has
 20 stated the funds are still allotted to each
 21 (inaudible) area. The contention is that this
 22 may mean affirmation or just most likely to
 23 happen?

24 MR. ABE: Right now based on our
 25 knowledge on what's happening out there, we

1 really feel we need more information in terms
 2 of the impacts from the cesspools. We
 3 estimate the cost to be 6.7 million dollars
 4 and that's a lot of money to spend sewerage
 5 that area. So we feel that we really need to
 6 do more studies to assess the impact.

7 The main concern with the cesspools are
 8 the nutrients. However, at Waimanalo there is
 9 a large number of sources of nutrients.
 10 There's agricultural fertilizers, animal
 11 waste, decaying vegetation and so on. So
 12 really we feel that we need to do further
 13 studies to actually quantify the amount
 14 nutrients from the cesspools relative to other
 15 sources of nutrients in Waimanalo.

16 As far as the funding, it will really
 17 depend on the City administration whether this
 18 is a high priority project. We did do a
 19 survey of the residents to see how they felt
 20 about the situation. We found that most of
 21 the residents are opposed to sewerage of the
 22 area and they would like to keep their
 23 individual waste water systems. One of the
 24 primary factors was cost. Most people felt it
 25 was too a high cost. They preferred to keep

1 their cesspool or septic tank systems.

2 MR. STEINBERGER: If there are no further
3 questions or comments at this time I would
4 like to thank Roy and everybody who attended
5 and call this public hearing to a close.
6 Thank you.

7 (Meeting closed at 7:37 p.m.)

8 -oOo-

CERTIFICATE

10 I certify that the foregoing transcript
11 was prepared to the best of my ability from
12 the electronic sound recording made of the
13 proceedings in the above-entitled matter, with
14 transcription performed under my supervision.

15 Dated: September 15, 1998
16 Bruce Getman
17 Bruce Getman

LIST OF PREPARERS

The following is a list of agencies, firms and persons that participated in the preparation of the DSEIS, SEISPN and Waimanalo Wastewater Facilities Plan documents.

Prime Consultant

Roy K. Abe, P.E., Vice President, Project Manager (Ph. 808-524-3771)
McLelland J. Smith, P.E., Project Engineer
Tina M. Unebasami, P.E., Project Engineer
Hawaii Pacific Engineers
1132 Bishop Street, Suite 1003
Honolulu, Hawaii 96913-2830

Groundwater (Nutrient and Microbial Contributions) Subconsultant

Dr. A.I. El-Kadi, Principal Investigator
Dr. Roger Fujioka, Co-Principal Investigator
Daniel J. Hoover
Tua M. Unutoa
Water Resources Research Center
University of Hawaii at Manoa

Geotechnical Subconsultant

Glen Y.F. Lau, P.E., President
Pacific Geotechnical Engineers, Inc.
1030 Kohou Street, Suite 101
Honolulu, Hawaii 96817

Electrical Engineering Subconsultant

Ronald C. Katahara, P.E., President
Aaron Hamada, P.E.
MK Engineers, Ltd.
286 Kalihi Street
Honolulu, Hawaii 96819

Chapter 11

References

CHAPTER 11

REFERENCES

Aotani & Hartwell Associates, Inc. , December 1975, "Hawaii State Comprehensive Outdoor Recreation Plan Technical Report," prepared for the State Department of Planning and Economic Development. Updated February 1982 by Wilson Okamoto & Associates.

Asquith, A., Biological summary accompanying listing package for five species of Hawaiian Megalagrion damselflies, unpublished document by the U.S. Fish & Wildlife Service, Pacific Islands Office, Honolulu, Hawaii, 1997.

Austin, Smith and Associates, Inc., "Job No. 41-M-15, Phase I Waimanalo Sewage Treatment Plant, Waimanalo Core Development Stage I, Waimanalo, Oahu, Hawaii," Department of Land and Natural Resources, State of Hawaii, 1969.

Barrett Consulting Group, "Job No. 31-OL-J, Waimanalo Wastewater Treatment Plant Improvements at Waimanalo, Oahu, Hawaii," State of Hawaii, Department of Land and Natural Resources, Division of Water and Land Development, Honolulu, Hawaii, September 1993.

Barrett Consulting Group, "Sludge Management Plan," for Department of Wastewater Management, City and County of Honolulu, July 1995.

Belt Collins Hawaii, "East Mamala Bay Wastewater Facilities Plan Final Environmental Impact Statement," submitted by Department of Wastewater Management, City and County of Honolulu, December 1993.

Belt Collins Hawaii, "Final Environmental Impact Statement and Land Use and Development Plan, Bellows Air Force Station, Waimanalo, Hawaii," U.S. Pacific Command, December 1995a.

Belt Collins Hawaii, "Waimanalo Wastewater Treatment Plant Modification, Phase I Design Report Preliminary (60%) Submittal," prepared for Department of Wastewater Management, City and County of Honolulu, May 1995b.

Bruner, Phillip L., "Avifaunal and Feral Mammal Survey of Bellows Air Force Station, Oahu," prepared for Belt Collins Hawaii, May 1994.

CH2M Hill, "Final Report, Nonpotable Water Study," prepared for Board of Water Supply, City and County of Honolulu, November 1995.

City and County of Honolulu, Department of Land Utilization, letter dated January 23, 1998 from Jan Noe Sullivan to Bert Saito of R.M. Towill.

City and County of Honolulu, Department of Parks and Recreation, J. Howe, personal communication, March 13, 1996a.

City and County of Honolulu, Department of Parks and Recreation, B. Suzuki, personal communication, December 6, 1996b.

City and County of Honolulu, Department of Public Works, "Design Standards of the Division of Wastewater Management, Volume II," July 1984.

City and County of Honolulu, Department of Public Works, Division of Wastewater Management, "Job No. W-18-92, Waimanalo Sewers, Section 2, Improvement District No. 269 Plans."

City and County of Honolulu, Department of Wastewater Management, "Design Standards of the Department of Wastewater Management, Volume I," July 1993.

City and County of Honolulu, Department of Wastewater Management, Division of Planning and Service Control, "Follow-up Report to the Spill Reduction Action Plan," December 1996.

City and County of Honolulu, "Koolaupoko Development Plan," April 1983 (with revisions).

City and County of Honolulu, Office of Council Services, Audit Section, "Long Range Financing Alternatives for the City's Wastewater System," April 1995.

City and County of Honolulu, Office of Human Resources, Neighborhood Data Book: Waimanalo, 1980.

City and County of Honolulu, Planning Department, "Briefing Package, Revision of the Development Plan for Koolaupoko," March 1998.

City and County of Honolulu, Revised Ordinances of Honolulu, December 31, 1990.

Consent Decree in U.S. District Court for the District of Hawaii; Save Our Bays and Beaches, Hawaii's Thousand Friends, Sierra Club, Surfrider Foundation, plaintiffs vs. City and County of Honolulu, defendant; Civil No. 92-00263.

El-Kadi, A.I. and R. Fujioka, "Assessment of Nitrogen and Microbial Contributions of Waimanalo Cesspool and Septic Tank Systems to Groundwater," Final Report to Hawaii Pacific Engineers, March 24, 1997.

Elhoff, Michael. Personal communication, Sales Consultant, Hawaii Engineering Services, December 1995.

Engineering Solutions, Inc., J. Nakamura, personal communication, September 5, 1996.

Engineering Science; Sunn Low Tom and Hara; and Dillingham Corporation. "Water Quality Program for Oahu with Special Emphasis on Waste Disposal, Final Report," prepared for City and County of Honolulu, Department of Public Works, February 1972.

Federal Emergency Management Agency, "Flood Insurance Rate Map, City and County of Honolulu, Hawaii," Panel 95 of 135. Revised September 4, 1987.

Figuroa, J., City and County of Honolulu, Department of Wastewater Management, personal communication, July 3, 1996.

Fletcher, Charles, and Clark Sherman, Department of Geology and Geophysics, School of Ocean & Earth Science Technology, University of Hawaii, personal communication, November 21, 1997.

Fujioka, R.S., and P.C. Loh, "Characterization of the Microbiological Quality of Water in Mamala Bay," Project MB-7, Mamala Bay Study Draft Report, September 30, 1995.

Fukunaga and Associates, Inc., "Flood Management Plans and Preliminary Engineering Studies for the Waimanalo Flood Control Project, Oahu, Hawaii," prepared for State of Hawaii, Department of Land and Natural Resources, August 1976.

- Fukunaga and Associates, Inc., "Preliminary Cost-Effectiveness Assessment for the Sewer Rehabilitation and Infiltration and Inflow Minimization Plan (Second Year)," December 1995.
- Fukunaga and Associates, Inc., "Statewide Capital Improvements Program, Flood Control Projects, Report R98," Division of Water and Land Development, Department of Land and Natural Resources, State of Hawaii, April 1994.
- Fukunaga and Associates, Inc. "Flood Management Plans and Preliminary Engineering Studies for the Waimanalo Flood Control Project, Oahu, Hawaii," Division of Water and Land Development, Department of Land and Natural Resources State of Hawaii, October 1976.
- Gerba, C.P., and I.A. Pepper, "Overall Impact of Sand Island Outfall on the Incidence of Pathogens in Mamala Bay," Project MB-7, Mamala Bay Study Draft Report, September 30, 1995.
- GTE Hawaiian Telephone, "The Everything Pages, Oahu Phone Directory, June 1998-1999."*
- Harding Lawson Associates, "Installation Restoration Program, Stage 1, Technical Report Final for Bellows Air Force Station, Hawaii," September 1992.
- Hawaii Office of State Planning, Hawaii Coastal Zone Management Program. "Hawaii's Coastal Zone Management Program, Management Plan, Volume 1," June 1996.
- Hawkins, Ivan, City and County of Honolulu, Department of Wastewater Management, Discussion on October 8, 1996 during plant site visit.
- Hill, R.T., J.G. Morris, A. Huq, "Molecular investigation of the Effect of Pollution on Pathogenic and Indigenous Bacteria in Mamala Bay," Project MB-7, Mamala Bay Study Draft Report, September 30, 1995.
- International Archaeological Research Institute, Inc., H. David Tuggle, "Draft Final Report- Archaeological Research of Areas Proposed for Development of Military Housing and Expansion of Military Training at Bellows Air Force Station, Oahu," April 1994.
- Kaio, D., Waimanalo Irrigation System Branch, Department of Agriculture, State of Hawaii, personal communication, December 2, 1996.
- Kan, P., Department of Wastewater Management, City and County of Honolulu, personal communication, November 20, 1996.
- Laws, E., University of Hawaii at Manoa, Department of Oceanography, School of Ocean and Earth Sciences Technology, personal communication, April 21, 1997.
- Laws, E., University of Hawaii at Manoa, Department of Oceanography, personal communication to R. Moulin, University of Hawaii at Manoa, Department of Geography, May 28, 1993.
- Leong, Richard, City and County of Honolulu, Department of Wastewater Management, "Memorandum for File," July 7, 1997 and "Feasibility Analysis on Kahaluu Sewers ID, Section 3 Project, LPSS, August 4, 1997.
- Lum, D., "Preliminary Report on Geohydraulic Exploration for Deep Well Disposal of Effluent, Waimanalo Sewage Treatment Plant, Oahu," prepared for the State of Hawaii, Department of Land and Natural Resources, Division of Water and Land Development, May 1969.
- Metcalf and Eddy, Inc. Wastewater Engineering, Treatment, Disposal and Reuse, McGraw Hill, 1991.

- Macdonald, G.A., A.T. Abbott, F.L. Peterson, Volcanoes in the Sea: Geology of Hawaii, UH Manoa, Honolulu, HI, 1983.
- Makaike, Ernest, Waimanalo WWTP Superintendent, Personal communication, August 19, 1996.
- Masa Fujioka & Associates, "Well Construction and Testing Report for Underground Injection Control Permitting, Waimanalo, Oahu, Hawaii," prepared for the Department of Land and Natural Resources, State of Hawaii. July 18, 1994.
- Mink, J.F. and L.S. Lau, Aquifer Identification and Classification for Oahu: Groundwater Protection Strategy for Hawaii, Technical Report No. 179, Water Resources Research Center, UH-Manoa, Honolulu, HI, February 1990.
- Moore, J.G., "Subsidence of the Hawaiian Ridge in Volcanism in Hawaii, Vol. 1." U.S. Geological Survey Professional Paper 1350.
- Oceanit Laboratories, Inc., personal communication with Dayananda Vithanage, November 15, 1996.
- Office of Hawaiian Affairs, State of Hawaii Department of Hawaiian Home Lands. "Waimanalo Kupuna Housing, Final Environmental Assessment," prepared by PBR Hawaii, March 1998.
- Pahren, H.R., and W. Jakubowski. "Health Aspects of Wastewater Aerosols," Water Science Technology, Vol. 13, 1981, pp. 1091-96.
- Park Engineering, Inc. and Environmental Communications, Inc., "Final Environmental Impact Statement, Agricultural Subdivision, Phase I Increment for the Waimanalo Agricultural Park," for the Department of Land and Natural Resources, Division of Water and Land Development, State of Hawaii, March 1982.
- Paulino, Connie B. "Application of Rapid, Alternative Methods to Monitor Waimanalo Watershed and Stream for Toxic Chemicals Under Dry and Rainy Conditions." Dissertation, University of Hawaii at Manoa, 1994.
- PBR Hawaii, "Hawaiian Home Lands: Land Inventory, Phase 5 - Planning Assessment: Total Land Inventory," Department of Hawaiian Home Lands, State of Hawaii, August 1993.
- Peterson, F.L., and S. Petty, "Hawaii Waste Injection Problems," prepared for the Department of Health, State of Hawaii, September, 1978.
- Raspicio, J, Waimanalo Irrigation System Branch, Department of Agriculture, State of Hawaii, personal communication, December 12, 1996.
- R.M. Towill Corporation, "Spill Response Action Plan Engineering Report," Chapters 1-4, for Department of Wastewater Management, City and County of Honolulu, November 1995.
- R.M. Towill Corporation, "Spill Response Action Plan Field Hydraulic Verification - Windward Region," February 1997.
- R.M. Towill Corporation, "Addendum #1, Flood Plain Determination for Inoaole Stream, Oahu, Hawaii," Contract No. DACA83-96-D-0002, prepared for U.S. Army Engineer Division, March 1997.
- R.M. Towill Corporation, "General Permit DOH NOI Form A, Quality of Discharge, Waimanalo Wastewater Treatment Plant Improvements," August 1, 1997.

R.M. Towill Corporation, personal communication with Craig Luke, April 10, 1998.

R.M. Towill Corporation, personal communication with Bert Saito, November 18, 1998.

Smith, Chris, U.S. Department of Agriculture, Natural Resources Conservation Service, personal communication, September 17, 1996.

State of Hawaii, Commission on Water Resources Management, "Hawaii Stream Assessment: A Preliminary Appraisal of Hawaii's Stream Resources," Report R84, prepared by the National Park Service, Hawaii Cooperative Park Studies Unit, December 1990.

State of Hawaii, Hawaii Historic Places Review Board, Hawaii Register of Historic Places, November 1993.

State of Hawaii, Land Use Commission, "Land Use District USGS Quadrangle Maps 014, Makapuu and 015, Koko Head," 1995.

State of Hawaii, Department of Planning and Economic Development, personal communication, March 1996.

State of Hawaii, Department of Health, Wastewater Branch, "Applicant Procedures to Participate in the Hawaii State Revolving Fund Loan Program," June 1995 (Revised June 1997).

State of Hawaii, Department of Health, "Wastewater Branch, Guidelines for the Treatment and Use of Reclaimed Water," November 22, 1993.

State of Hawaii, "Administrative Rules, Title 11, Department of Health, Chapter 23, Underground Injection Control," July 6, 1984.

State of Hawaii, "Administrative Rules, Title 11, Department of Health, Chapter 54, Water Quality Standards," November 12, 1982.

State of Hawaii, "Administrative Rules, Title 11, Department of Health, Chapter 55, Public Health Regulations," October 15, 1992.

State of Hawaii, "Administrative Rules, Title 11, Department of Health, Chapter 59, Ambient Air Quality Standards," October 29, 1993.

State of Hawaii, "Administrative Rules, Title 11, Department of Health, Chapter 60.1, Air Pollution Control," October 29, 1993.

State of Hawaii, "Administrative Rules, Title 11, Chapter 62, Department of Health, Wastewater Systems," August 30, 1991.

State of Hawaii, Department of Land and Natural Resources. "Flood Control and Flood Water Conservation in Hawaii, Volume II, General Flood Control Plan for Hawaii, Circular C93," September 1983.

State of Hawaii, Department of Land and Natural Resources. "Post Flood Report, New Year's Eve Storm, December 31, 1987-January 1, 1988, Windward and East Oahu," Circular C119, July, 1988.

State of Hawaii, Department of Health and City and County of Honolulu, "208 Water Quality Management Plan for the City and County of Honolulu." December, 1980.

State of Hawaii, Department of Health and City and County of Honolulu, "208 Water Quality Management Plan for the City and County of Honolulu." September 1990.

State of Hawaii, Department of Health, Clean Air Branch. "Hawaii Air Quality Data, 1991-1993."

State of Hawaii, Department of Health, "Waimanalo Wastewater Treatment Plant (WWTP), Underground Injection Control (UIC), UIC Permit No. UO-1259." February 15, 1995.

State of Hawaii, Department of Health, Environmental Planning Office, "Hawaii's Water Quality-Limited Waters: The 1996 Assessment, Draft for Public Review," January 1997.

State of Hawaii, Department of Business, Economic Development and Tourism, State of Hawaii Data Book 1995, A Statistical Abstract.

Takasaki, K.J., and J.F. Mink, "Evaluation of Major Dike-Impounded Ground-water Reservoirs, Island of Oahu," U.S. Geological Survey Water Supply Paper 2217, 1985.

Takasaki, K.J., and J.F. Mink, "Water Resources of Southeastern Oahu, Hawaii," U.S. Geological Survey Water Resources Investigation 82-628, 1982.

Thompson, Joseph "Waimanalo Preliminary Water Quality Study, An Assessment of Non-point Source Water Pollution in the Hydrologic Unit." Diss. University of Hawaii at Manoa, 1993.

Tulang, Dennis, Chief, Wastewater Branch, Department of Health, State of Hawaii, Meeting of June 7, 1996.

U.S. Air Force, 15th Air Base Wing, "Final, Streamlined Risk Evaluation and Closure Document Letter Report, Volume II of III, Bellows Excess Land Engineering Evaluation/Cost Analysis, Bellows Air Force Station," August 1997.

U.S. Department of Commerce, Weather Bureau, Rainfall Frequency Atlas of the Hawaiian Islands, Technical Paper No. 43, 1962.

U.S. Department of the Interior, Fish and Wildlife Service, Office of Biological Services, National Wetlands Inventory, 1978.

U.S. Department of Agriculture, Soil Conservation Service, in cooperation with the University of Hawaii Agricultural Station, Soil Survey of Islands of Kauai, Oahu, Maui, Molokai, and Lanai, State of Hawaii, August 1972.

U.S. Department of Agriculture, Soil Conservation Service (lead agency) and State of Hawaii, Department of Land and Natural Resources, Division of Water and Land Development, "Final Watershed Plan and Environmental Impact Statement, Waimanalo Watershed," December 1981.

U.S. Environmental Protection Agency, A Plain English Guide to the EPA Part 503 Biosolids Rule, EPA/832/R-93/003, September 1994.

U.S. Environmental Protection Agency, "40 Code of Federal Regulations (CFR) Parts 257, 403 and 503, Standards for the Use and Disposal of Sewage Sludge," February 1992.

U.S. Federal Emergency Management Agency, "Flood Insurance Rate Map, City and County of Honolulu, Hawaii," Panel 95 of 135, September 4, 1987.

U.S. Fish and Wildlife Service, "Stream Channel Modification in Hawaii. Part A: Statewide Inventory of Streams: Habitat Factors and Associated Biota," Biological Services Program, April 1978.

Wilson Okamoto and Associates, Inc., "Waimanalo Facility Plan," prepared for Division of Wastewater Management, Department of Public Works, City and County of Honolulu, January 1984.

Wilson Okamoto and Associates, Inc., "Revised Environmental Impact Statement, Waimanalo Wastewater Facilities," Proposing Agency: Division of Wastewater Management, Department of Public Works, City and County of Honolulu, January 1984.

Wu, Arvin C. "Assessing the Water Quality of the Waimanalo Watershed by Measuring Indicator Bacteria Densities in Waimanalo Stream, Inoaole Stream, and in Waimanalo Bay." Diss. University of Hawaii at Manoa 1994.

Yamashita, Peter, Olomana Golf Links, personal communication, November 12, 1996.

Young, Steve, City and County of Honolulu, Planning Department, personal communication, April 17, 1996.

Appendix A

**Waimanalo WWTP Upgrade
Technical Information**

**TABLE A-1
CONCEPTUAL YEAR 2020 DESIGN DATA AND RECOMMENDATIONS
FOR UPGRADE OF THE WAIMANALO WWTP¹**

Design Flows and Loadings

Average Flow, mgd	1.1
Base wastewater flow, mgd	0.85
Dry weather infiltration/inflow, mgd	0.25
Maximum Flow, mgd	1.8
Maximum wastewater flow, mgd	1.53
Maximum flow factor (max. flow/base flow)	1.8
Peak Flow, mgd (5-year storm)	4.8
Wet weather infiltration/inflow, mgd	3.0
Estimated Future Ultimate Peak Flow, mgd ²	6.0
Influent BOD ₅	
Concentration, mg/L	240
Loading, lb/day	2,200
Influent Total Suspended Solids	
Concentration, mg/L	240
Loading, lb/day	2,200

Septage Receiving Facilities

Manhole with coarse screening basket (1.5 inch mesh). Washdown hose bibb. Paved driveway and fenced area with access gate.

Influent Pump Station

New Pump	Install new lower capacity pump with variable frequency drive and associated piping. Size pump to accommodate maximum daily flow (approximately 1.8 mgd)
Recycle Piping for Wetwell Mixing	Perform piping modifications to recycle flow from discharge manifold to mix wetwell.
Structural	Replace corroded wetwell rungs.

Influent Sampling Station

Influent Sampler	Automatic refrigerated type with corrosion resistant weatherproof enclosure.
Piping Modifications/Recycle Flow Flow Metering	Consider rerouting existing sand bed filtrate and digester supernatant lines to a flow monitoring vault. Install instrumentation to subtract recycle flows from influent venturi flow meter. Investigate other alternatives as appropriate.

TABLE A-1
CONCEPTUAL YEAR 2020 DESIGN DATA AND RECOMMENDATIONS
FOR UPGRADE OF THE WAIMANALO WWTP (Continued)

<u>Grit/Screenings Building</u>	Install ventilation fans. No other major modifications.
<u>Equalization Facilities</u>	
Description	Side-line equalization basin of reinforced concrete construction
Total Tank Volume, mgal	0.20
No. of Tank Compartments	2
Aeration	Floating aspirated-air type aerators
Pumping	Submersible non-clog centrifugal with variable frequency drives and level controls. Minimum of two pumps.
<u>Primary Clarifiers</u>	Repair cracks in concrete. Repair corrosion and apply protective coatings on metal work.
<u>Anoxic-Aerobic Activated Sludge Tanks</u>	
No. of Anoxic Tanks	3 tanks in series (converted Rapid Bloc tanks)
No. of Aerobic Tanks	2 tanks in parallel (with four compartments each)
Tank Volume	
Total, mgal	0.206
Anoxic, mgal	0.046
Aerobic, mgal	0.160
Retention time	
Total, hrs	5.6
Anoxic, hrs	1.0
Aerobic, hrs	4.6
Tank Sidewater Depth, ft	14
Design MLSS Concentration, mg/l	2,500
Aerobic SRT, days	4.1
Design temperature (minimum), degrees C	25
Oxygen Required	
Average load, lb/hr	94
Peak day, lb/hr	149
Type of Diffusers	Ceramic fine bubble (full floor coverage)

TABLE A-1
CONCEPTUAL YEAR 2020 DESIGN DATA AND RECOMMENDATIONS
FOR UPGRADE OF THE WAIMANALO WWTP (Continued)

Anoxic-Aerobic Activated Sludge Tanks (Continued)

Internal Recycle Pumps	
Type	Submersible low head propeller type.
Recycle flow, mgd	4.4
Return activated sludge rate	
Average, gpm	950
Maximum, gpm	1,500
Mixing in anoxic zone	Coarse bubble aeration. (As an alternative, mixing may also be accomplished with submersible mixers)

Final Clarifiers

Type:	Circular basin of reinforced concrete construction.
No. of tanks	2
Diameter, ft	50
Total Tank Surface Area, sf	3,930
Surface overflow rate	
At average flow, gpd/sf	280
At maximum flow, gpd/sf	430
At peak flow, gpd/sf	1,220
Side Water Depth, feet	15
Design Features	Flocculating influent well, inboard launders with Stamford baffles, and spiral scrapers.

RAS/WAS Pump Station

Description	Dry pit pumps housed in a reinforced concrete/masonry building.
RAS Pumps	Dry pit non-clog centrifugal pumps* with variable frequency drives. One pump for each clarifier and one standby pump.
WAS Pumps	Positive displacement solids handling pump with variable frequency drives and timer controls. Two pumps (one serving as standby).

*Operations personnel requested that the use of "Discflo" pumps be investigated.

**TABLE A-1
CONCEPTUAL YEAR 2020 DESIGN DATA AND RECOMMENDATIONS
FOR UPGRADE OF THE WAIMANALO WWTP (Continued)**

Filtration Facilities

Type of Filtration	Contact filtration utilizing granular media filters.
Filters**	
Type	Upflow continuous backwashing type utilizing reinforced concrete tanks.
Media	Sand: 40" depth, 1.3 mm effective size.
No. of filter modules	9
Area per filter module, sq ft	50
Total filter area, sq ft	450
Filtration rate at avg. flow, gpm/sf	1.7
Filtration rate at max. flow, gpm/sf	2.3
Flow at 4.0 gpm/sf max. design filtration rate, mgd	2.6
Backwash flow at avg. flow, gpm	50
Maximum headloss at max. filtration rate, inches	24

** Based on a request by the WWM operations staff, R.M. Towill Corporation is including 21 filters modules in its design documents to provide additional capacity to handle existing bulking sludge and peak flow conditions. A relatively low filtration rate is being used to minimize head losses and thereby eliminate the need for filter influent pumps. Funding limitations are expected to allow only construction of not more than nine modules.

Chemical Feed System	Package type polymer feed system with polymer aging tank. Masonry building (600 sf) to house equipment, chemicals and motor controls.
Instrumentation and Controls	Continuous turbidity monitor with automatic diversion of flow to injection wells upon high turbidity.

Ultraviolet (UV) Disinfection Facilities

Type	Low intensity UV system in open channel. High intensity self cleaning systems may also be considered.
Design UV Dosage	140 Mw-sec/cm ² at maximum flow 100 Mw-sec/cm ² at peak flow
Design Flow, mgd	2.0 (initial assumed max. irrigation flow rate)
Estimated UV Transmittance	55 to 65 percent (verify during design phase)
Controls	Automatic (UV dosage controlled by flow pacing, on-line transmissivity and turbidity monitoring)

**TABLE A-1
CONCEPTUAL YEAR 2020 DESIGN DATA AND RECOMMENDATIONS
FOR UPGRADE OF THE WAIMANALO WWTP (Continued)**

Chlorination Facilities

Proposed Modifications
(by WWM)

Sodium hypochlorination facilities will be installed in the existing injection well compressor building for periodic shock chlorination of the injection wells and emergency chlorination of the effluent.

Effluent Pump Station

Reinforced concrete wetwell with separate compartments for irrigation reuse and low lift effluent pumping. For farm lots and Olomana Golf Links projects, two submersible or vertical turbine pumps each with variable frequency drives. Overflow to injection wells. Two propeller type low lift pumps to pump peak flow to injection wells.

Injection Wells Effluent Disposal

No. of wells	3
Depth, feet	200
Diameter, inches	16

Backwashing features Compressed air with backwash to drying beds.

Sludge Pumping Facilities

Primary Sludge Pumping

Install solenoid valves on existing air lift pumps. Replace existing primary sludge transfer pumps with Discflo pumps.

Scum Pumping

Install submersible scum pump in existing scum pit.

Dissolved Air Flotation (DAF) Thickener

Type

Circular reinforced concrete tank. Sludge pumps* housed on covered pad. Air dissolution equipment in Grit/Screenings Bldg.

*Operations staff recommended the use of "Discflo" pumps where feasible.

Capacity

Thicken WAS or primary sludge (ranging from 85 gpm at 0.5 percent solids to 50 gpm at 1 percent solids) to 4 to 5 percent solids.

**TABLE A-1
CONCEPTUAL YEAR 2020 DESIGN DATA AND RECOMMENDATIONS
FOR UPGRADE OF THE WAIMANALO WWTP (Continued)**

Dissolved Air Flotation (DAF) Thickener

No. of tanks	1
Diameter, ft	20
Total Tank Surface Area, sf	314
Sidewater Depth, feet	10
Hydraulic Loading, gpm/sf	0.8
Solids Loading, lb/hr/sf	1.0
Operating Pressure, psig	70
Air/Solids Ratio	3
Polymer Feed, lb/ton	4 - 10

Anaerobic Digesters

Replace existing sludge recirculation pump with new Discflo pump. Purchase an uninstalled spare pump.

Drying Beds Modifications

Plastic Media Bed Modifications

Type

Slotted "Wedgewater" plastic media.

Area, sf

2,400 sf (two existing beds)

Loading

Maximum of 4 pounds of solids per square foot with a 4 day turnover time.

Sludge Pump

Positive displacement solids handling pump. Minimum capacity of 200 gpm.

Polymer Feed

Package type polymer feed system with polymer aging tank.

Other Modifications

Install new sand bed stop log gates on nine west side sand beds to reduce leakage.

Install and concrete strips for vehicle access on nine west side sand beds.

Electrical System Improvements

Install second HECO transformer, new motor controls and distribution system, and 300 KW/375 KVA generator and fuel tank.

Administration/Personnel/Maintenance/
Storage Building

Construct a new 2,700 sf masonry building consisting of supervisor's office, lunch room, restroom/shower facilities, maintenance shop and storage facilities.

TABLE A-1
CONCEPTUAL YEAR 2020 DESIGN DATA AND RECOMMENDATIONS
FOR UPGRADE OF THE WAIMANALO WWTP (Continued)

Water System Upgrade

Install new water main and two new fire hydrants. (New system to replace existing corroded 4-inch water main from water meter at Kalaniana'ole Highway to the plant entrance)

Non-potable Water System

Install non-potable water system utilizing reclaimed water for grounds irrigation, tank washdowns and other uses.

Notes:

1. The information presented is subject to refinement during the design phase.
2. Ultimate flow to be used for sizing of channels and conduits where appropriate to accommodate future increase in flow.

DATE: 02/13/97
 SCALE: 1" = 1'
 FILE: 9524-53A

MS
 PM: SHA-FAI
 OPER: SHAW
 REVISED: 01/05/98

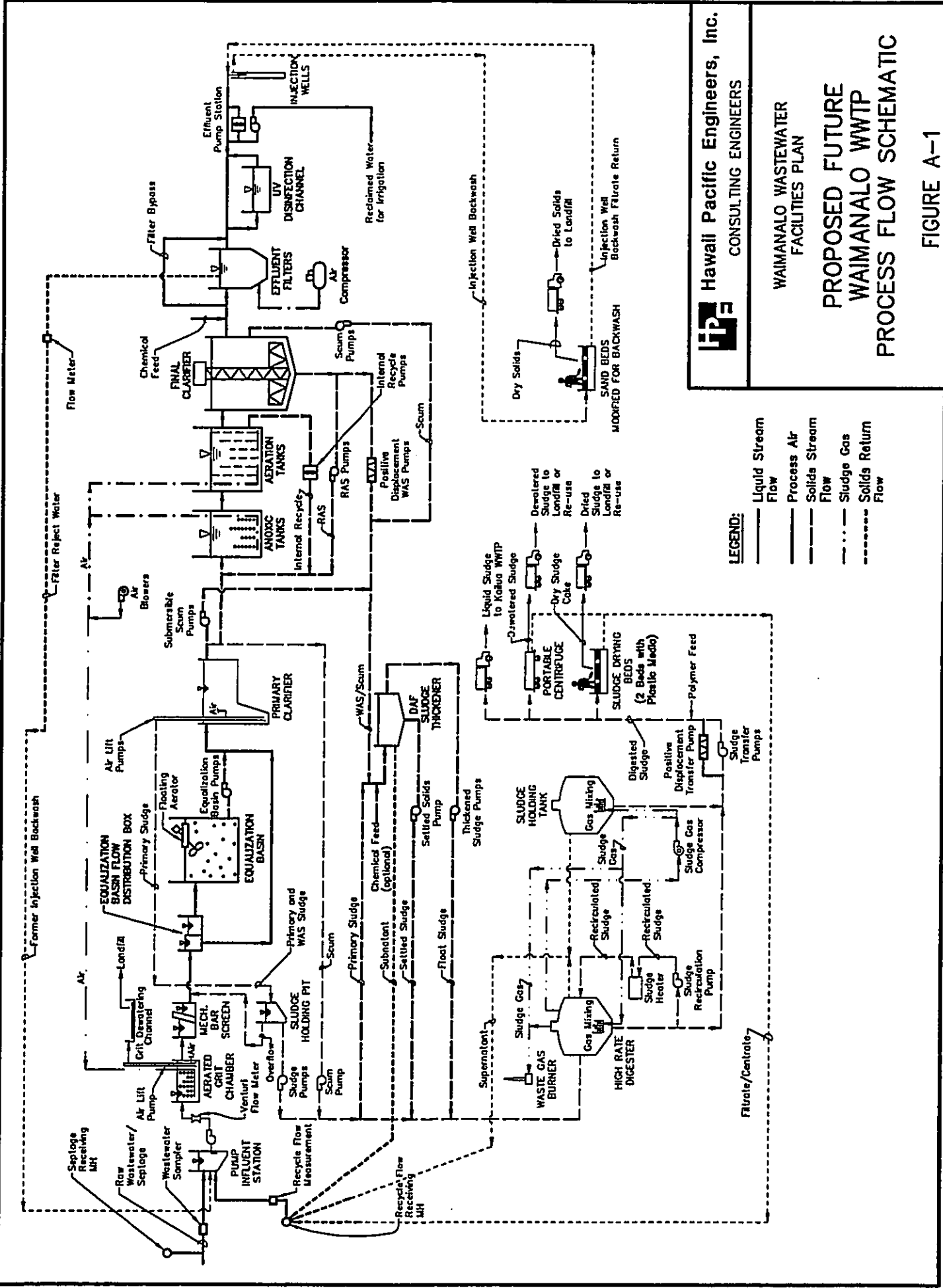

HPE Hawaii Pacific Engineers, Inc.
 CONSULTING ENGINEERS

WAIMANALO WASTEWATER FACILITIES PLAN

PROPOSED FUTURE WAIMANALO WWTP PROCESS FLOW SCHEMATIC

FIGURE A-1

LEGEND:

- Liquid Stream Flow
- - - Process Air Flow
- · · Solids Stream Flow
- · - Sludge Gas Flow
- - - Solids Return Flow

Appendix B

Water Quality Standards and Parameters

APPENDIX B

WATER QUALITY STANDARDS AND PARAMETERS

GENERAL

Water quality standards developed by the State of Hawaii Department of Health (DOH) are set forth in Chapter 54, "Water Quality Standards," of the Hawaii Administrative Rules. The purpose of this appendix is to provide background information on state water quality standards and parameters that apply to fresh and marine surface waters of the Waimanalo study area.

CLASSIFICATION OF WATERS

The Chapter 54 water standards take into account the natural differences and wide range of waters in the state by classifying the waters based on physical characteristics, ecological systems, and beneficial uses.

General Classification of Waters by Physical Characteristics

State waters are classified into two general classifications: inland waters and marine waters. Inland waters are further classified as either freshwater or brackish/saline waters. Marine waters are classified as embayments, open coastal waters, and oceanic waters.

Open coastal waters are defined as water extending from shoreline to the 100-fathom (600 feet) depth. Waters beyond the 100-fathom depth are classified as oceanic waters. Embayments are defined as marine waters confined and protected by land mass and with restricted openings.¹ Waimanalo Bay is not classified as an embayment.

The Chapter 54 standards further classify certain waters as "wet" or "dry." For open coastal waters, the "wet" water quality criteria is applicable when freshwater discharge per mile of shoreline is greater than 3 million gallons per day (mgd). When the discharge is less than 3 mgd per mile, then the "dry" criteria is applicable. The approximate wet and dry criteria boundaries established by DOH for the Waimanalo open coastal waters is shown on Figure B-1 along with the beneficial use classifications.

¹The criteria for the restriction is the ratio of total bay volume to the cross-sectional entrance area of 700 to 1 or greater.

DATE: 4/20/88 PM: RKA
SCALE: 1"=4000' OPER: CDK
FILE: 9521-50A REVISED: -

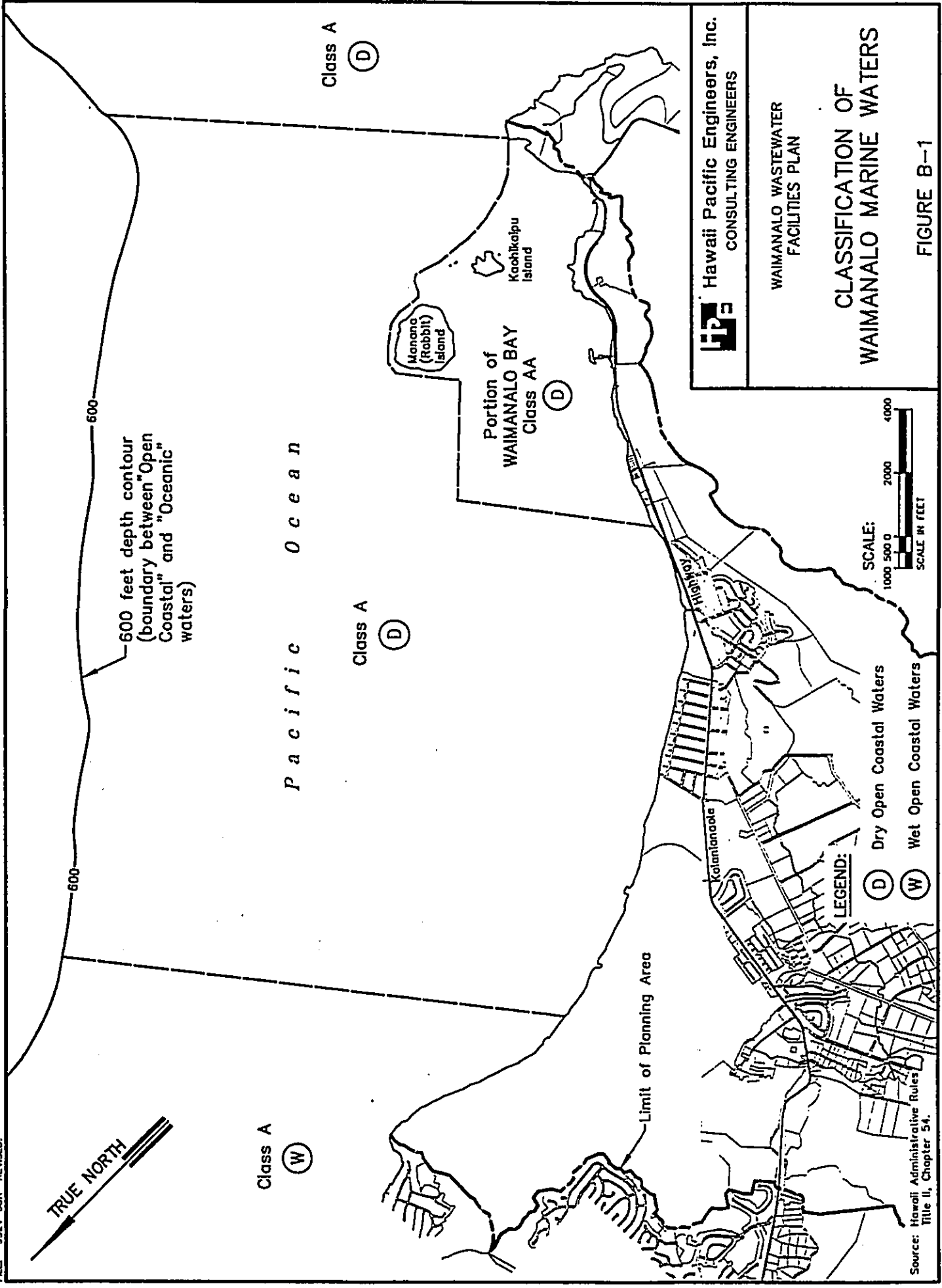

HPE Hawaii Pacific Engineers, Inc.
CONSULTING ENGINEERS

WAIMANALO WASTEWATER
FACILITIES PLAN

CLASSIFICATION OF WAIMANALO MARINE WATERS

FIGURE B-1

Source: Hawaii Administrative Rules
Title II, Chapter 54.

Inland waters (except for estuaries) are subject to a "wet" and "dry" criteria that is based on the waters being subject to a wet and dry season. The wet season is specified as occurring between November 1 and April 30. The dry season is considered to occur from May 1 through October 31.

1. Classification of Waters by Ecological Systems

The Chapter 54 standards identify various ecological subtypes for the different inland water classifications, and various bottom subtypes for embayments and open coastal waters. The ecological classifications are summarized on Table B-1.

Inland water bodies in Waimanalo include streams and low wetlands. The marine bottom ecosystems along Waimanalo's coastline include sand beaches, lava rock shoreline, artificial basins, reefs and soft bottom communities.

2. Classification of Waters by Beneficial Uses

Inland and marine waters are further classified by Chapter 54 with respect to beneficial uses of the waters for the purpose of defining and applying appropriate water quality parameters and protection measures. The applicable water classifications based on beneficial uses is presented in Table B-2.

There are two classes of inland waters. All inland streams and wetlands in the Waimanalo area are designated as Class 2 waters, with the exception of an area in the uppermost portion of the Waimanalo stream drainage basin along the Koolau Mountain Range ridgeline. The objective of Class 2 waters is "to protect their use for recreational purposes, propagation of fish and aquatic life, and agricultural and industrial water supplies, shipping, navigation and propagation of shellfish. The uses to be protected in this class of waters are all uses compatible with recreation in and on these waters. These waters shall not act as receiving waters for any discharge which has not received the best degree of treatment or control compatible with the criteria established for this class." The upper most portion of Waimanalo's streams is classified at Class 1. This class of waters is required to remain in its natural wilderness state or character.

Marine waters are divided into two classes. Class AA marine waters are to "remain in their natural pristine state as nearly as possible with an absolute minimum of pollution or alteration of water quality from any human-caused source or actions. To the extent practicable, the wilderness character of such areas shall be protected." No zones of mixing for outfalls in nearshore waters are permitted in this class. The objective for Class A marine waters is that "their use for recreational purposes and aesthetic enjoyment be protected."

**TABLE B-1
SUMMARY CLASSIFICATION OF STATE WATER BASED ON
ECOLOGICAL SYSTEMS**

INLAND WATERS	
WATER TYPES	ECOLOGICAL SUBTYPES
Fresh waters	(1) Streams (perennial or intermittent) (2) Springs, seeps, natural lakes, and reservoirs (3) Elevated wetlands (4) Low wetlands
Brackish waters or saline waters	(1) Coastal wetlands (2) Estuaries (3) Anchialine pools (4) Saline lakes

MARINE WATERS	
WATER TYPES	BOTTOM SUBTYPES
Embayments or open coastal waters	(1) Sand beaches (2) Lava rock shorelines and solution benches (3) Marine pools and protected coves (4) Artificial basins (5) Reef flats (6) Soft bottoms
Oceanic waters	

Source: Compiled from Title 11, Chapter 54, Hawaii Administrative Rules (1992).

**TABLE B-2
BENEFICIAL USES OF STATE INLAND AND MARINE WATERS BY
WATER CLASSIFICATION**

INLAND WATERS	
WATER CLASSIFICATION	BENEFICIAL USES TO BE PROTECTED:
Class 1	Natural state or condition, wilderness character
Class 1.a	Scientific and educational purposes, breeding stock, compatible recreation, aesthetic enjoyment
Class 1.b	Domestic water supplies, food processing, propagation of aquatic life, compatible recreation, aesthetic enjoyment
Class 2	Recreational purposes, propagation of fish and other aquatic life, agricultural water supply, industrial water supply, shipping, navigation, propagation of shellfish

MARINE WATERS	
WATER CLASSIFICATION	BENEFICIAL USES TO BE PROTECTED:
Class AA	Natural pristine state, wilderness character, oceanographic research, propagation of shellfish and other marine life, conservation of coral reefs and wilderness areas, compatible recreation, aesthetic enjoyment
Class A	Recreational purposes, aesthetic enjoyment, propagation of fish, shellfish and wildlife

MARINE BOTTOM ECOSYSTEM	
BOTTOM CLASSIFICATION	BENEFICIAL USES TO BE PROTECTED:
Class I	Natural pristine state, non-consumptive research, non-consumptive education, aesthetic enjoyment, passive activities, preservation
Class II	Propagation of fish, shellfish and wildlife, recreational purposes

Source: Title 11, Chapter 54, Hawaii Administrative Rules (1992).

The open coastal waters (shoreline to 600 foot depth) of Waimanalo Bay are designated as Class A waters, except in the southern reaches of the bay where they are classified as AA waters. The boundary of this Class AA area extends from the southern boundary of Kaiona Beach Park to Makapuu Point, including waters surrounding the Manana and Kaohikaipu islands. The approximate boundaries of the two classes of open coastal waters for Waimanalo are shown on Figure B-1. All oceanic waters (depths greater than 600 feet) are classified as Class A.

Water Quality Parameters and Standards

The Chapter 54 Water Quality Standards establish limiting values of physical, biological and chemical parameters in order to define the water quality of the various water classifications. These parameters include:

- Salinity
- Temperature
- Turbidity
- pH
- Dissolved oxygen
- Light extinction coefficient
- Fecal coliform and enterococci bacteriological indicator organisms
- Total nitrogen, ammonia nitrogen, nitrate plus nitrite nitrogen
- Total phosphorus, orthophosphate,
- Chlorophyll a
- Dissolved solids
- Settleable solids
- Floatables
- Radionuclides
- Various specific toxic and carcinogenic substances
- Pollutants from nonpoint sources

Chapter 54 includes limits for the various parameters. Some of the key water quality standards are briefly addressed below. Background information on some of the key water quality parameters is presented in the last section of this appendix.

Specific criteria established for stream and open coastal waters are summarized in Table B-3 and B-4 respectively for both "wet" and "dry" conditions. The criteria presented in these two tables are applicable to the streams and coastal waters in Waimanalo.

**TABLE B-3
STATE RECEIVING WATER QUALITY STANDARDS
FOR STREAMS**

Parameter	Geometric Mean not to Exceed the Given Value		Not to Exceed the Given Value More Than 10% of the Time		Not to Exceed the Given Value More Than 2% of the Time	
	Wet ¹	Dry ²	Wet ¹	Dry ²	Wet ¹	Dry ²
Total Kjeldahl Nitrogen, ($\mu\text{g N/L}$) ³	250.0	180.0	520.0	380.0	800.0	600.0
Nitrate + Nitrite Nitrogen ($\mu\text{g NO}_3 + \text{NO}_2\text{-N/L}$) ³	70.0	30.0	180.0	90.0	300.0	170.0
Total Phosphorus ($\mu\text{g P/L}$) ³	50.0	30.0	100.0	60.0	150.0	80.0
Turbidity (Nephelometric Turbidity Units)	5.0	2.0	15.0	5.5	25.0	10.0
Total Suspended Solids (mg/L)	20.0	10.0	50.0	30.0	80.0	55.0

Notes:

1. "Wet" criteria apply November 1 through April 30.
2. "Dry" criteria apply May 1 through October 31.
3. The criteria are shown in micrograms per liter ($\mu\text{g/L}$) in terms of the constituents indicated (N for nitrogen, P for phosphorous). One milligram per liter (mg/L) is equal to 1,000 $\mu\text{g/L}$.

Other Parameters (applicable to both "wet" and "dry" conditions.):

- pH units - Shall not deviate more than 0.5 units from ambient conditions and shall not be lower than 5.5 nor higher than 8.0.
- Dissolved oxygen - Not less than 80 percent of saturation.
- Temperature - Shall not vary more than 1°C from ambient conditions.
- Specific conductance - Not more than 300 micromhos/centimeter.

**TABLE B-4
STATE RECEIVING WATER QUALITY STANDARDS
FOR OPEN COASTAL WATERS**

Parameter	Geometric Mean not to Exceed the Given Value		Not to Exceed the Given Value More Than 10% of the Time		Not to Exceed the Given Value More Than 2% of the Time	
	Wet ¹	Dry ²	Wet ¹	Dry ²	Wet ¹	Dry ²
Total Kjeldahl Nitrogen, ($\mu\text{g-N/L}$)	150.00	110.00	250.00	180.00	350.00	250.00
Ammonia Nitrogen, ($\mu\text{g NH}_4\text{-N/L}$)	3.50	2.00	8.50	5.00	15.00	9.00
Nitrate + Nitrite Nitrogen ($\mu\text{g NO}_3 + \text{NO}_2\text{-N/L}$)	5.00	3.50	14.00	10.00	25.00	20.00
Orthophosphate Phosphorus ($\mu\text{g PO}_4\text{-P/L}$)	7.00	5.00	12.00	9.00	17.00	13.00
Total Phosphorus ($\mu\text{g P/L}$)	20.00	16.00	40.00	30.00	60.00	45.00
Light Extinction Coefficient (k units)	0.20	0.10	0.50	0.30	0.85	0.55
Chlorophyll <i>a</i> ($\mu\text{g/L}$)	0.30	0.15	0.90	0.50	1.75	1.00
Turbidity (Nephelometric Turbidity Units)	0.50	0.20	1.25	0.50	2.00	1.00
Total Suspended Solids ($\mu\text{g/L}$)	20,000	10,000	30,000	15,000	40,000	20,000

Notes:

1. "Wet" criteria apply when the open coastal waters receive more than three million gallons per day of fresh water discharge per shoreline mile.
2. "Dry" criteria apply when the open coastal waters receive less than three million gallons per day of fresh water discharge per shoreline mile. (Per State 208 Plan, dry criteria apply to waters near the Mokapu Ocean Outfall.)

Other Parameters (applicable to both "wet" and "dry" conditions.):

- pH Units - Shall not deviate more than 0.5 units from a value of 8.1.
- Dissolved Oxygen - Not less than 75 percent of saturation.
- Temperature - Shall not vary more than 1°C from ambient conditions.
- Salinity (mg/L) - Shall not vary more than 10 percent from natural or seasonal changes considering hydrologic input and oceanographic factors.

Bacteriological standards for recreational waters is a key criteria for evaluating the water quality of recreational waters from a public health and safety standpoint. The Chapter 54 standards utilize the fecal coliform (*Escherichia coli*) and enterococci bacteria as indicators of contamination by wastewater. The standards are as follows:

- Inland Recreational Waters: Fecal coliform geometric mean not to exceed 200 per 100 mL in ten or more samples collected in any thirty day period with not more than ten percent of the samples exceeding 400/100 mL.
- Marine Recreational Waters (within 1,000 feet of the shoreline): Enterococci geometric mean not to exceed seven per 100 mL in not less than five samples equally spaced at six day intervals (or unequally spaced at five, six, seven or eight day intervals provided that the total period covered is between 25 and 30 days).

The Chapter 54 standards also recognize the necessity of limited zones of mixing for the assimilation of point discharges. The objective of a zone of mixing is to provide a realistic means of control over such discharges, and at the same time, achieve the highest attainable overall level of water quality. Currently, there are no point loads discharges to the waters of Waimanalo Bay and therefore there are no existing zones of mixing.

BACKGROUND ON WATER QUALITY PARAMETERS

The following discussions provide a brief overview of key biological, chemical and physical water quality parameters. The levels of these parameters in local waters may affect the public health and environmental quality in the study area.

Microbiological Indicators

Microbiological indicators refer to bacteria whose presence in water above a threshold limit indicate fecal contamination, and the potential threat to public health due to pathogens. Indicators are used because pathogens are generally relatively few and difficult to culture under laboratory conditions. The common microbiological indicators are briefly discussed below.

1. Fecal coliform

A class of bacteria that are found in human waste, and are therefore found in wastewater in significant numbers. Fecal coliform are also found in the waste from birds and animals.

2. Esherichia coli

A member of the coliform population and is more representative of fecal sources than other coliform bacteria, E. coli is always present in wastewater in high concentrations, approximately 10^6 /mL.

3. Enterococci

Enterococci are generally found in lower concentrations than other indicator organisms; however, they exhibit better survival in seawater.

4. Clostridium perfringens

This is a spore-forming anaerobic persistent bacteria, and its characteristics make it a desirable indicator where disinfection is employed, where pollution may have occurred in the past, or where the interval before analysis is protracted. In Hawaii, research has shown that other indicator bacteria, once seeded are capable of multiplying in soil. As a spore former, C. perfringens is less likely to multiply outside of a host.

Nutrients

Primary productivity in tropical open ocean waters is generally influenced or limited by nutrient availability. The relative scarcity of these nutrients is responsible for the pristine nature of the ocean waters surrounding Hawaii. Shoreward, however, the availability of these "limiting" nutrients may increase due to land influences, man's activities, and phenomena such as upwelling of deep ocean waters.

The two most common limiting nutrients are the elements nitrogen and phosphorous. The various forms of nitrogen and phosphorous are discussed below.

1. Nitrogen

Nitrogen is necessary for the synthesis of proteins. In water, total nitrogen is comprised of organic nitrogen, ammonia, nitrite and nitrate.

a. Organic nitrogen

Biological decomposition of organic nitrogen changes the form to ammonia. Total Kjeldahl nitrogen is the total of the organic and ammonia nitrogen.

b. Ammonia nitrogen

Ammonia nitrogen in aqueous solution exists either as ammonia (NH_3) or as the ammonium ion (NH_4^+) depending on the pH.

c. Nitrite and nitrate nitrogen

In an aerobic environment, bacteria can oxidize ammonia to nitrite (NO_2^-) and nitrate (NO_3^-). Nitrite nitrogen is relatively unstable and is easily oxidized to the nitrate form; it seldom exceeds a concentration of 0.1 mg/L in surface waters. Nitrate nitrogen is the most highly oxidized form of nitrogen found in wastewaters; the predominance of the nitrate form indicates that the water has been stabilized with respect to oxygen demand.

2. Phosphorous

The usual form of phosphorous found in aqueous solution include the orthophosphate, polyphosphate, and organic phosphate. Orthophosphates (for example PO_4^{3-} , HPO_4^{2-} , H_2PO_4^- , H_3PO_4) are available for biological metabolism without further breakdown.

Turbidity

Turbidity is the optical measurement of the properties of light scattered or absorbed as a result of suspended particulate matter in water. In the environment turbidity is related to the amount of sediment that will be deposited in the nearshore environment. In wastewater treatment, turbidity is related to the dose of either chlorine or ultraviolet light required to achieve a given level of disinfection.

Dissolved Oxygen

The level of dissolved oxygen required to maintain the stability and well-being of aquatic or marine environments is a critical consideration with respect to nutrients, fine particles, dissolved solids, and temperature. These are properties that affect the depletion of dissolved oxygen in unpolluted waters. Oxygen levels below 2 to 3 mg/L are suspected to cause anoxia in fish.

Salinity

Salinity is the concentration (by weight) of dissolved inorganic matter after all bromide and iodide have been replaced by the equivalent amount of chloride, and all carbonate converted to oxide. For practical reasons, salinity is usually measured indirectly as

chlorinity, which is defined as the mass of halogens (chlorides and bromides) contained in one kilogram of sea water.

Salinity is the major factor in determining whether the regime of nearshore waters is marine or estuarine. Salinity also, with temperature, determines the nature of vertical stratification of the water column in marine waters.

Temperature

Temperature affects the rate of chemical reactions and biological processes. Stream and nearshore water temperatures in Hawaii do not vary seasonally to a significant extent, generally fluctuating with ambient conditions.

pH

pH is a measure of the acidity (low) or basicity (high) on a logarithmic scale. A pH of 7 is neutral. In natural water bodies, pH is a function of chemical and biological processes. pH is a factor in the type of aquatic life that can inhabit an ecosystem.

Chlorophyll-a

Chlorophyll-a is the primary photosynthetic pigment in all living plants and constitutes approximately 1 to 2 percent of the dry weight of organic matter of all algae. Chlorophyll-a measurements are used as an estimate of phytoplankton biomass in marine waters. Many water quality parameters affect phytoplankton productivity, including light, nutrients, temperature, salinity, turbidity, and suspended solids. With other water quality parameters, chlorophyll-a levels can help define the extent and impacts of point and nonpoint sources of pollution.

Appendix C

**Literature Review on
Individual Wastewater Systems**

APPENDIX C

LITERATURE REVIEW ON INDIVIDUAL WASTEWATER SYSTEMS

GENERAL

The purpose of this literature review is to provide background information on individual wastewater treatment systems (cesspools and septic tank/soil absorption systems) with respect to public health concerns and water quality impacts. The literature search presented herein focuses on two key issues related to the use of individual wastewater treatment in Waimanalo. These two issues are:

- The effectiveness of individual wastewater systems in removing or inactivating pathogenic microbes (primarily bacteria and viruses) that are associated with public health concerns; and
- The effectiveness of individual wastewater *systems* in removing nutrients, particularly nitrogen, that are suspected of contributing to algal blooms in nearshore coastal waters.

The majority of the research cited in this literature review was conducted on septic tank/soil absorption systems. The results of septic tank systems research, however, is also applicable in large part to cesspool systems. Winneberger (1984) noted that septic tank and cesspool systems differ primarily in geometry. The septic tank has a separate, gravel-filled, subsurface disposal field while the cesspool does not. Functionally, the inner wall of the cesspool is a leaky septic tank, and the outer soil wall is the subsurface disposal field.

The mechanisms for removal and attenuation of contaminants within the soil are similar in many respects for septic tank and cesspool systems. Particularly in Hawaii, however, there can be substantial differences between systems due to differing soil and groundwater conditions in which the systems are constructed. Since cesspools extend deeper into the ground, they are more likely to encounter and take advantage of (from a clogging standpoint) the more permeable formations such as coral, sand and fractured basalt. Cesspools are also much more likely to be located below or near the water table and encounter saturated soil conditions.

ATTENUATION OF PATHOGENS

There are various types of biological agents associated with wastewater that are responsible for causing diseases. The following discussion on pathogens is limited to

bacteria and viruses. The literature indicates that other pathogenic biological agents, such as various types of worms, yeasts and protozoa, are not a major concern with individual wastewater treatment systems. These other pathogenic agents are much less of a factor than bacteria and viruses due to predators of these agents being present in the cesspool/septic tank and the generally effective filtering action of the soil.

Fate of Pathogens in Septic Tanks

1. Bacteria

Winneberger (1984) reported that early researchers noted bacterial removals from 40 to 50 percent from wastewaters passed through septic tanks. He noted, however, that the bacteria of interest are the pathogenic ones, rather than the overall population of bacteria. He also noted that pathogenic microbes, in general, are host specific and do not survive well outside of the host. He concluded that most pathogens would not be expected to find safety in the septic tank environment, since it is likely to contain pathogen predators.

Calabro (1971) studied the microbiology of septic tanks and the survival of Salmonella typhimurium. The study noted that *the* enteric pathogen tends to die out within two weeks and "... does not appear to pose any immediate danger to handlers of septage."

Kreissl (1978) noted that the factors important in the efficiency of removal of pathogens include soil type, temperature, pH, organism adsorption to soil, and soil clogging mechanisms. Another key factor is the liquid flow regime in the soil. Unsaturated flow, induced by either a clogged zone or application rate, enhances purification because liquid movement is primarily through only the smaller pores of the soil, forcing greater liquid-soil contact.

Kreissl also states that septic tank systems installed in sands also exhibit the effects of the clogging zone in removing indicator bacteria. The kinds and numbers of bacteria found in the liquid one foot below and one foot to the side of the trench in a medium sand soil were similar to natural soil flora.

2. Viruses

Winneberger (1984) reported that viruses are so small (0.01-0.45 μ) that electrical charges of their surfaces may determine their fate in septic tank systems. He cited studies at the University of California and later private studies (Winneberger, 1963; McGauhey, 1968) that established beyond doubt that suspended solids in septic tanks were electrically charged. The studies found that the suspended

solids responded to cationic and anionic flocculants, depending on whether the sewage was comparatively fresh or many years old. Inasmuch as viruses are charged particles and respond to flocculants, Winneberger felt that viruses are likely to become attached to septic tank solids and share their fate.

Winneberger (1984) cited investigations by the U.S. Geological Survey conducted in cooperation with the University of Miami (Pitt et al., 1975). In these studies, septic tank sludge particles were found to exhibit polyelectrolytic (flocculant) behavior. When viruses were added to wet sludge, none appeared in the supernatant fluid. The viruses attached to the sludge could only be removed by increasing the pH to 8.0, a condition not normally found in septic tanks.

Fate of Pathogens in Soil

Kaplan (1991) reported that published research documenting measurements of microbial travel in soil vary significantly. Some researchers report bacteria or viruses having traveled hundreds of feet within the soil; others report that bacteria and viruses are effectively retained within less than a foot of soil. Kaplan cites two primary reasons for the differences:

- The conditions in which the travel or retention took place were different; all of the variables (soil structure, moisture conditions, temperature, pH, etc.) affecting travel or retention were not controlled or accounted for; and
- Different types of bacteria or viruses have differing characteristics with respect to their fate in soil. For example, one particular type of virus may be much more readily adsorbed by a given clay soil at a given soil pH than another type of virus. Similarly, one type of bacteria may survive longer and travel farther in a viable state than another.

Kaplan cited the work of Hagedorn et al. (1981) who reviewed pertinent literature and arrived at a number of conclusions. These conclusions, which were slightly modified by Kaplan, are as follows:

- Microorganisms move only a few feet in unsaturated soil, but much larger distances in saturated soil.
- Bacterial retention is higher in finer-textured soil.
- The main limitation to travel through soils is physical straining or filtration (for bacteria or larger microbes).

- Adsorption plays a role in retention of bacteria, and increases with clay content.
- Death of the microorganism plays an important role. Death may occur due to ingestion by other organisms, adverse soil conditions (no nutrients, drying, antagonistic organisms' secretions, such as antibiotics), and "aging" during long retention periods.

Hagedorn et al. reviewed experimental results published by Bouma in 1972. Bouma's results indicate that one to three feet of unsaturated soil below a leachline's clogging mat was adequate for complete bacteria removal. Hagedorn concluded that the U.S. Public Health Service's "Manual 526" standard of four to five feet of "suitable" soil was in line with Bouma's experimental data.

Tasato et al. (1980) studied the treatability of raw domestic wastes using pilot-scale wastewater treatment lysimeters. The lysimeters contained four different types of Oahu soils, two silty clays of the Wahiawa and Lahaina series, a silty loam of the Tantalus series, and a beach sand of the Jaucas series.¹ The mean removal efficiencies of the Wahiawa series for *Fecal streptococcus*, *Fecal coliform* and total coliform were 69, 84 and 39 percent, respectively. The mean removal efficiencies of the Lahaina series for *Fecal streptococcus*, *Fecal coliform* and total coliform were 78, 88 and 81 percent, respectively. The mean removal efficiencies for the Tantalus series for *Fecal streptococcus*, *Fecal coliform* and total coliform were 92, 87 and 83 percent, respectively. The mean removal efficiencies for the Jaucas series for *Fecal streptococcus*, *Fecal coliform* and total coliform were 84, 87 and 88 percent, respectively. The researchers concluded that removal efficiencies in applying raw wastewater to soils were "only moderate" for the bacterial constituents studied.

Hori et al. (1970) investigated the migration of Poliovirus Type 2 through three Oahu soils, Wahiawa and Lahaina humic Latosols and Tantalus cinder. The study demonstrated the ability of poliovirus to move through all of the soils, but did not investigate the factors affecting the retention of the virus. In the humic latosols, virus removal ranged from 96.6 to 99.3 percent over a period of five days for rates up to 20 bed volumes but breakthrough of the virus was immediate. Fifteen-inch deep columns of Tantalus cinders, a granular soil, showed immediate breakthrough of the virus and removal rates of 22 to 35 percent.

The fate of septic tank effluent in the vadose (unsaturated) zone of fine sand soils in Florida was studied by Anderson et al. (1994). The researchers constructed an in-situ field lysimeter research facility to evaluate the treatment capability of the soil over

¹The Beach Lot area of Waimanalo is largely underlain by beach sand of the Jaucas series.

time, under controlled conditions in the field. The vadose zone thicknesses that were investigated were two and four feet for each experimental condition. The loading rates were 0.75 and 1.5 gpd/ft². After nine months of monitoring, the results indicated that substantial attenuation of key septic tank effluent pollutants were achieved. No positive sample tests were observed for Fecal coliform or Fecal streptococcus bacteria at the sampling locations below the infiltration system. This study indicates that significant attenuation of the fecal indicators occurs in the sandy soil.

Kaplan (1991) believes that the USEPA Design Manual: Onsite Wastewater Treatment and Disposal Systems (1980) recommended minimum separation between leachline bottom and groundwater of 2 to 4 feet is inadequate. In defense of his position, he noted the following:

- Much of the knowledge about wastewater purification is below leachline bottom and groundwater is derived from studies about distribution of bacteria in the soil profile after a clogging mat develops. Bacterial and especially viral movement can be more extensive before the mat is fully developed.
- Capillary "suction" can maintain the continuity of large diameter soil water columns from the bottom of the leachline to groundwater, and decrease "sieving" or filtration.
- Coarse-textured soils can absorb much rainfall; absorbed rainfall creates a layer (or layers) of nearly saturated soil. While the soil is draining, bacteria and viruses may be "washed down."
- Mounding of effluent can raise the level of groundwater.
- From a practical standpoint, minimum requirements become the standards of practice. Soil conditions throughout the nation are much more varied than those near a few experimental leachlines. Few design professionals know when (or dare) to exceed the minimum requirements.
- Depth to shallow groundwater is at least as variable as the weather, and usually cannot be predicted with certainty (unless drains are installed). As for methods such as observing mottles in the soil stratum, such techniques are not reliable due to the variables involved (time of submergence, rainfall, presence and location of decomposable organic matter, parent material, etc.). For instance, Couto et al. (1985) found no indications of groundwater in soil that experienced groundwater at a two foot depth for more than 120 days per year.

- Not enough data exists to ascertain a safe distance of travel through soil for trapping all types of viruses.

McGinnis and DeWalle (1983) concluded that movement of typhoid bacteria from a leachline down through at least 3 or 4 feet of "less than 1 or 2 minutes per inch sand,"² and thence through 210 feet of saturated soil (i.e., groundwater) down-gradient to a well. The researchers also tabulated the distances traveled by other types of bacteria as reported in other publications. The distances ranged from 1 to 300 feet in sandy aquifers, 2,800 feet in gravelly aquifers, and 3,300 feet in a fractured limestone.

Kaplan (1991) noted that the extent of bacterial movement occurring in soil and water can be expected to occur also for viral movement under comparable conditions.

Vaughn and Landry (1983) reviewed 182 publications and compiled a comprehensive picture of viral movement. The researchers noted a report of poliovirus moving downward from a leachfield and then laterally 300 feet to a well. In another instance, under rapid-infiltration units receiving secondary-treated effluent, viruses were recovered 93 feet down and 567 feet lateral distance away from the units. One study reported Coxsackie virus being recovered 1,250 feet downgradient from a sanitary landfill. Another study reported recovering a coliphage which moved 2,800 feet under saturated soil conditions at a rate of 1,400 feet per day.

Vaughn and Landry noted that when viruses enter a leachfield, they may be metabolized by microbes, or they may be adsorbed onto the bacterial slime in and around the clogging mat. The viruses, however, may also continue to travel and be adsorbed in charged soil particles (mostly clays), and be inactivated by Al_2O_3 or MnO_2 , two fairly common clay fraction constituents. Adsorption to the usually abundant SiO_2 and Fe_2O_3 constituents does not inactivate viruses. Rainfall can desorb viruses and carry them down in a still viable state. Vaughn and Landry further noted that virus adsorption is extremely variable as different strains of the same virus may adsorb to a different extent. Even within a purified population of virus particles, some subgroups adsorb at different rates. The researchers noted that dry soil appears to kill or inactivate viruses.

Bechdol et al. (1994) used VIRALT, an EPA approved viral fate model, to estimate the risk of drinking water well contamination by viruses stemming from septic system discharges. The modeling results indicated that:

²"Minutes per inch" refers to the rate of water level change in a percolation test. One to two minutes per inch is typical for a coarse to medium sand.

- The depth of the unsaturated zone separating the bottom of the soil absorption system from the water table was the dominant factor influencing the viral concentration entering the water table, and
- The primary factor influencing viral concentration at the well head was the time of travel within the saturated zone.

It should be noted that the model was not calibrated to field conditions, although the authors felt that the model results were nevertheless valid.

Kaplan (1991) states that old concepts about separations between leachfields and groundwater and wells need updating. Kaplan also states that standards currently in vogue seem to have been influenced by a single study published in 1970, in which Romero (1970) cataloged and interpreted available data on microbial travel through soils. Currently, it is recognized that not enough is known to predict how far various viruses can travel under specific soil conditions, particularly under actual field conditions (mass loadings, rainfall-saturated soil, clogging mats that are not fully developed, and root channels).

Despite the many unknowns, however, past studies generally indicated that the control of viral pollution depends primarily on passing wastewater through a biomat and/or through unsaturated soil with sufficient adsorption sites within its matrix (mostly from clay or silt). Other things being equal, research indicates that comparatively little viral adsorption and inactivation occurs after viruses reach groundwater and move through the saturated soil. Generally, the vertical unsaturated zone separations between leachfields and groundwater are far more critical than the horizontal saturated zone separations between leachfields and wells.

ATTENUATION OF NUTRIENTS

The following discussions on nutrients focuses primarily on the various forms of nitrogen that are of concern in wastewater treatment and disposal, and the associated transformations within and downstream of individual wastewater disposal systems. While phosphorous is sometimes a concern, much of this constituent is generally adsorbed to soil particles as the wastewater travels through the soil matrix. In contrast, some forms of nitrogen, particularly nitrates, are not adsorbed by the soil. Nitrates can pass readily through the soil and groundwater, and ultimately enter and adversely impact the nearshore environment.

Table C-1 presents typical characteristics of raw wastewater and septic tank effluent from several different studies, as compiled by Pell et al. (1990).

TABLE C-1
CONCENTRATIONS OF POLLUTANTS IN HOUSEHOLD WASTEWATER

Parameter	Raw (EPA, 1980)	Septic Tank Effluent		
		(Pell et al., 1990)	(Nilsson, 1990)	(EPA, 1978)
BOD ₅ (mg/L)	200 -290	n.d.	140	138
COD (mg/L)	680 -730	258	300	327
Total N (mg/L)	35 -100	53	40	49
Total P (mg/L)	18 -29	14	15	n.d.
Suspended Solids (mg/L)	200 -290	n.d.	75	45

Notes:

1. Source of data in parentheses ().
2. n.d. = not determined by study.

Blackwater (toilet wastewater), as compared to graywater (remainder of household wastewater), accounts for more than 75 percent of the total nitrogen in domestic wastewater but accounts for only 20-40 percent of the daily flow (Whitmeyer et al, 1991).

In order to fully comprehend the fate of nitrogen compounds in individual wastewater systems and the environment, it is necessary to understand the transformations that nitrogen compounds may undergo at key stages of the wastewater "nitrogen cycle."

About one-quarter to one-third of the organic nitrogen in raw wastewater is part of the fecal protein (fecal amino acids and amino sugars). The remainder is part of urea (urine's main nitrogen compound). In the septic tank or cesspool, bacterial enzymes converts urea into ammonia and carbon dioxide. Fecal proteins, when decomposed, may also release ammonia. Ammonia combines with water to form ammonium ions (NH₄⁺).

Aerobic bacteria oxidize the ammonium ions to nitrite (NO₂⁻) and then to nitrate (NO₃⁻). All of the above reactions are aerobic, i.e. they take place in the presence of dissolved oxygen (O₂). This process is called nitrification.

In an anoxic (without dissolved oxygen) environment, certain types of bacteria are able to use the nitrate (NO₃⁻) oxygen atoms (in lieu of dissolved oxygen) and reduce nitrate to molecular nitrogen. For this process to proceed, the bacteria must also have a source of carbon (sugars, organic acids, alcohols, aldehydes or any other biodegrad-

able matter). This process, known as denitrification, results in nitrogen and oxygen gases being released and is a principal means of nitrates (nitrogen) removal.

The following discussions provide a review of studies investigating the fate of nitrogen in septic tanks systems and the surrounding soil.

Fate of Nitrogen in Septic Tanks

According to Winneberger (1984), septic tanks would be expected to remove organic nitrogen by settling sludge and flotation of scum. In addition, he states that nitrogen compounds converted to ammonia by bacteria becomes the positively charged ammonium ion and would be attracted to negatively charged wastewater particles remaining in the tank. He also asserts that data exists to support his conclusion that some of the organic nitrogen is converted to nitrogen gas and dispelled to the atmosphere. This occurrence of both nitrification and denitrification in the tank would require both aerobic and anoxic environments within the tank. Winneberger recognizes this and suggests that the anoxic environment is by far the most dominant. His data indicates that portions of septic tanks near the inlet at times do have sufficient dissolved oxygen to sustain the aerobic nitrification processes.

Winneberger also references work by McGauhey (1968) and Laak (1974) which indicate that most of the nitrogen removed in the septic tank is organic nitrogen removed in the sludge and scum. Laak estimated that about 34 percent of the nitrogen disposed to a septic tank was removed in the tank itself. In comparison, Kaplan (1991) estimated that only four percent nitrogen is lost in septage (sludge) pumping. The USEPA Design Manual Onsite Wastewater Treatment and Disposal Systems (1980) stated that data is sketchy, but reported that two to ten percent of the total nitrogen from the home is typically removed as septage. The manual states that approximately 65 to 75 percent of the total nitrogen in septic tank effluent is in the ammonia form, indicating significant decomposition of organic nitrogen.

On the basis of the literature, there is some disagreement as to the amount of nitrogen removed by septic tanks. This difference may be due to differing operating assumptions and conditions among the researchers.

Fate of Nitrogen in Soil

Tasato et al. (1980) studied the treatability of raw domestic wastes using pilot-scale wastewater treatment lysimeters. The lysimeters contained four different types of Oahu soils, two silty clays of the Wahiawa and Lahaina series, a silty loam of the Tantalus series, and a beach sand of the Jaucas series. The researchers concluded that ammonia nitrogen removals for raw wastewater were only moderate, possibly because of overloading of the lysimeters used in the experiments.

Kreissl (1978) states that septic tank effluent contains about 80 percent ammonia and 20 percent organic nitrogen, but that much is converted to the nitrate form as it moves through the aerated unsaturated soil immediately below the clogging zone.

Koizumi et al. (1966) performed infiltration and percolation tests of synthetic and domestic municipal wastewater through Oahu soils in simulated cesspool lysimeters. The soil types were a Lolekaa Humic Latosol and a Wahiawa Low Humic Latosol which were placed in bench scale lysimeters. Infiltration rates ranged from 0.7 to 3.6 ft./day. Both the domestic and synthetic wastewater exhibited a 90 percent reduction in organic nitrogen. The level of the nitrates in the effluent of the domestic wastewater increased three-fold to 53 mg/L, clearly indicating the conversion of ammonia to nitrates. This observation demonstrated the presence of an aerobic environment in the immediate vicinity of the soils around the cesspool.

As noted previously, the fate of septic tank effluent in the vadose zone of fine sand soils in Florida was investigated by Anderson et al (1994). The results indicated that substantial attenuation of key septic tank effluent pollutants were achieved. BOD reductions were in excess of 98 percent and total Kjeldahl nitrogen (TKN) reductions were in excess of 97 percent. Nitrate-nitrogen generated from nitrification was transported to both the two and four foot depths, but at lower concentrations (approximately 20 mg/l-N) than the total nitrogen applied to the soil (TKN of approximately 44 mg/l-N), indicating some reduction of total nitrogen concentrations within the soil system.

Oberdorfer et al. (1982) performed studies on disposal of secondary effluent in injection wells at the Waimanalo and Paalaa Kai WWTPs on Oahu. While not directly applicable to cesspools, the study provides some evidence of denitrification occurring in a saline sandy aquifer at the Waimanalo WWTP test site. On the basis of the field observations, the researchers theorized that the nitrified effluent would be denitrified in the groundwater under anoxic conditions. The investigators were concerned with "gas binding" in the soil pores around the injection well that would lead to increased resistance to effluent injection. The researchers assumed that sufficient carbonaceous material was available in the effluent to allow denitrification to proceed.

Concurrent aerobic conversion of ammonia to nitrate and the anoxic conversion of nitrate to nitrogen gas within the soil receiving septic tank effluent has been postulated by Winneberger (1984). Accordingly, the microanaerobic environment is asserted to be capable of complete or nearly complete removal of nitrogen from percolating wastewaters. Winneberger estimated the loss of nitrogen through the soil conservatively at 85 percent.

In contrast, Sikora et al. (1976) asserted that "passage of septic tank effluent through a seepage field (leachfield) usually results in a nitrified effluent with insufficient BOD (biochemical oxygen demand) levels to support denitrification." Perkins (1985) observed that "... data relating chemical contamination (of groundwater), especially nitrate contamination, to septic tank density are becoming numerous." Perkins cited nine different studies to support his conclusion.

As described by Kaplan (1991), Eastburn et al. (1985) reviewed fairly current literature (as of 1985) that included reports of up to 48 to 86 percent denitrification in some mound systems and concluded that "denitrification rates under conventional septic system may vary from 0 to 35 percent." Kaplan went on to cite other studies that are in agreement with Eastburn. In studies on wastewater irrigation, Broadbent and Aref (1984) report nitrogen losses of up to 32 percent when wastewater was percolated through aerobic soil columns. Also cited was a study by Broadbent and Reisenauer (1984) which noted that coarse textured, well drained soils with low organic matter content have negligible denitrification potential; sandy loam and loam soils have medium denitrification potential (10 to 20 percent nitrogen loss); and finer textured soils, high potential (20 to 40 percent nitrogen loss).

Research Findings on Methods to Increase Nitrogen Removal

Pell (1990) reported on some techniques for improving denitrification in sand filters treating septic tank effluent. Alternating cycles of flooding and drying increased the denitrification rate from zero to about 30 percent. Decreasing the loading rates were reported to increase nitrogen loss from 10 to 80 percent. Drying periods allow air to penetrate the bed, creating an environment for nitrification. The subsequent flooding periods bring the denitrifying bacteria in contact with stored nitrate. The technique requires careful control of the volume of effluent directed to the bed to avoid nitrate leaching through before denitrification is complete. Adding external carbon sources such as methanol or septic tank sludge to the sand bed was reported to increase nitrogen removal rates from 55 to 100 percent. These types of systems require specialized sand filter structures to allow staged nitrification/denitrification to take place, and require some additional operation and maintenance on the part of the owner.

The inconsistent and somewhat contradictory results of studies investigating nitrification and denitrification in conventional septic tanks and drainfields has led to a shift in approach to individual wastewater treatment research. In recent years, much of the research on nitrogen removal in individual wastewater systems has focused on systems that use two or more processes in series to achieve nitrogen removal. Whitmeyer et al. (1991) evaluated various processes for enhancing biological nitrogen removal for septic tank systems. These process included

aerobic/anaerobic trickling filter package plant, peat filters, "RUCK," recirculating sand filter, recirculating sand filter with anaerobic filter, recirculating sand filter with anaerobic filter and carbon source, recirculating sand/rock storage filter, mound/constructed wetland. Each of these processes utilize biological denitrification to achieve nitrogen removal. Brief descriptions of each process are as follows:

- Aerobic/anaerobic trickling filter package plant (AAPTFFP): A synthetic media trickling filter receives wastewater from overlying spray-heads for aerobic treatment and nitrification. Filtrate returns to the lower anaerobic zone to mix with incoming septic tank effluent and undergo denitrification. A portion of the mixed wastewater is discharged for disposal after a set time of treatment. Any sludge which accumulates in the unit is returned to a septic tank. A programmable controller is used to coordinate pumping cycles.
- Peat Filter (PF): Construction occurs in an excavation lined with an impervious material. A layer of gravel and underdrain piping are installed at the peat base for efficient drainage and anti-flotation. The outlet invert of the underdrain piping is installed above the bottom to create saturated conditions in the rock. As septic tank effluent moves through the bed, nitrogenous compounds undergo nitrification, denitrification (postulated to occur in microsites of anaerobiosis), and microbial assimilation.
- RUCK: The "RUCK" system combines source separation with biological processes to achieve nitrogen removal. Separate interior collection systems are installed to collect blackwater and graywater. Each discharges to a septic tank. Effluent from the blackwater tank passes on to a subsurface, layered, intermittent sand filter. Nitrified blackwater discharged from the sand filter combines with effluent from the graywater septic tank in an anaerobic upflow rock filter. Rock in the filter provides surface area for growth of denitrifying bacteria and promotes wastewater-microorganism contact. Carbon in the graywater provides an energy source for denitrifying microorganisms.
- Recirculating Sand Filter (RSF): Septic tank effluent discharged to a recirculation tank mixes with filtrate, returned by gravity from a sand filter. This mixture is pumped onto the sand filter. As wastewater passes through the filter, nitrification occurs. A portion of the sand filter effluent is discharged for disposal. Some denitrification is achieved in the system, however, the location of occurrence and processes involved are unknown.
- Recirculating Sand Filter with Anaerobic Filter (RSF w/AF): Septic tank effluent discharged to the bottom of an anaerobic upflow rock filter mixes

with filtrate, returned by gravity from a sand filter. This mixture flows to a recirculation tank and is pumped onto the sand filter. As wastewater passes through the sand filter, nitrification occurs. Filtrate returns to the anaerobic filter by gravity. Rock in the filter provides surface area for the growth of denitrifying microorganisms and promotes wastewater-microbial contact. Carbon in septic tank effluent serves as an energy source for the denitrifiers. A portion of sand filter effluent is discharged for disposal.

- Recirculating Sand Filter with Anaerobic Filter and Carbon Source (RSF w/AF & CS): Septic tank effluent discharged to a recirculation tank mixes with filtrate, returned by gravity from a sand filter. This mixture is pumped onto the sand filter. As wastewater passes through the sand filter, nitrification occurs. A portion of the sand filter effluent and the chemical carbon source is discharged to an anaerobic upflow rock filter. Rock in the filter provides surface area for the growth of denitrifying microorganisms and promotes wastewater-microbial contact. The added carbon, e.g. ethanol or methanol, serves as an energy source for the denitrifiers. Anaerobic filter effluent is discharged for disposal.
- Recirculating Sand/Rock Storage Filter (RSF2): Septic tank effluent is discharged to one end of a rock storage filter which lies directly below and in the same compartment as a sand filter. Septic tank effluent flows horizontally through the rock and enters a pump chamber at the other end. Wastewater is pumped onto the sand filter. As wastewater passes through the filter, nitrification occurs. Filtrate is collected from near the top of the rock storage filter into a second pump chamber and is returned to the anaerobic environment of the septic tank where raw wastewater can serve as a carbon source for denitrifying microorganisms. A portion of wastewater flow from the second pump chamber is discharged for disposal.
- Mound/Constructed Wetland (MCW): Septic tank effluent is discharged to a mound subsurface infiltration system. The mound is constructed over an impervious liner that slopes toward a constructed wetland. As wastewater percolates through the unsaturated mound fill, it is nitrified. Mound filtrate flows over the impervious liner toward the wetland. The wetland, constructed for subsurface flow, has gravel filled cells planted with hydrophilic plants such as cattail, common reed, or water hyacinth. Nitrogen in the wastewater is removed primarily by denitrification.

Whitmeyer ranked the above systems in terms of estimated construction cost and mass nitrogen removal efficiencies as shown in Table 2. The data reflects 1991 construction costs in the state of Wisconsin. Costs in Hawaii would be substantially

higher. On the mainland, treatment efficiency was typically found to vary seasonally. The treatment efficiency in Hawaii would not be appreciably seasonally affected. Above 10°C, nitrification rates range from 70 to nearly 100 percent, so performance would be expected to be higher than shown in Table C-2.

**TABLE C-2
NITROGEN REMOVAL SYSTEMS
CONSTRUCTION COST AND PERFORMANCE**

System	Mass Removal Efficiency (%)	Reliability (Service Period ¹)	Retrofit Ability	Estimated Cost ²
AAPTFP	45-50	Semi-annual	Moderately Easy	\$11,300
PF	50-60	Semi-annual	Moderately Easy	\$5,800
RUCK	40-60	> Annual	Difficult	\$8,300
RSF	40-70	> Annual	Moderately Easy	\$8,300
RSF W/AF	50-70	Annual	Moderately Easy	\$9,300
RSF w/AF&CS	≥90	Annual	Moderately Easy	\$10,300
RSF2	≤70	Semi-annual	Moderately Easy	\$11,300
MCW	NA ³	Semi-annual	Moderately Easy	NA ³

Notes:

1. Average time between service calls.
2. For design flow of 450 gallons/day; Septic tank size: 1,000 gal.; Septic tank cost: \$1/gal.; Lift station (tank, pump, and controls) \$2,000 lump sum; Subsurface wastewater infiltration site (SWIS) soil loading rate: 0.5 gal/ft², SWIS size reduction for secondary quality: 30-40%, SWIS cost: \$3/ft².
3. Information and/or data not available.

Based on estimates by Whitmeyer, the annual operation and maintenance costs for the systems averaged \$130 for labor and \$80 for other costs (based on 1991 dollars with energy costs of \$0.08/kw-hr and labor rate of \$10/hour).

Boyle et al. (1994) investigated the potential of full scale anaerobic upflow sand filters and peat filters for treatment of septic tank effluent. The results showed that both treatment systems were effective in removing BOD and suspended solids, but only the sand filters were effective in removing nitrogen. The sand filters produced effluent with typical total nitrogen concentrations of 15 mg/L which translates to a typical mass removal of 75 percent. The peat filters produced removal levels of 40 percent at best.

Mote et al. (1994) investigated the performance of a prototype partially saturated recirculating sand filter for nitrogen removal from septic tank effluent. The filter produced average total nitrogen reductions of 71 percent with recirculation rates of 4.4 times the influent flow. When the recirculation factor was increased to 7.7, the average total nitrogen reductions of 83 percent were observed. For the same periods, COD removal averaged 86 and 96 percent. The average fecal coliform reduction was 95.0 and 99.8 percent and the total coliform reduction was 95.0 and 99.5 percent. The researchers noted that the use of septic tank effluent as a carbon source precludes the complete removal of nitrogen from the filter effluent, since the energy source itself contains an appreciable amount of nitrogen.

REFERENCES

Anderson, D.L., R.J. Otis, J.I. McNeillie, R.A. Apfel, "In-situ Lysimeter Investigation of Pollutant Attenuation in the Vadose Zone of a Fine Sand," Proceedings of the Seventh International Symposium on Individual and Small Community Sewage Systems, December 1994.

Bechdol, M.L., A.J. Gold, J.H. Gorres, "Modeling Viral Contamination from On-Site Wastewater Disposal in Coastal Watersheds," Proceedings of the Seventh International Symposium on Individual and Small Community Sewage Systems, December 1994.

Bounds, T.R., "Septic Tank Septage Pumping Intervals," Proceedings of the Seventh International Symposium on Individual and Small Community Sewage Systems, December 1994.

Boyle, W.C., R.J. Otis, R.J. Apfel, R.W. Whitmyer, J.C. Converse, B. Burkes, M.J. Bruch, Jr., M. Anders, "Nitrogen Removal from Domestic Wastewater in Unsewered Areas," Proceedings of the Seventh International Symposium on Individual and Small Community Sewage Systems, December 1994.

Broadbent, F.E., and K.E. Aref, "Nitrification and Denitrification of Municipal Wastewater Effluents Disposed to Land," Publication No. 58, California State Water Resources Control Board, Sacramento, CA, 1984a.

Broadbent, F.E., and Reisnauer, H.M., Fate of Wastewater Constituents in Soil and Groundwater: Nitrogen and Phosphorus, in "Irrigation with Reclaimed Municipal Wastewater," Report No. 84-1WR, California State Water Resources Control Board, Sacramento, CA, 1984b.

Calabro, J.F., Microbiology of Septage, Doctoral Thesis, University of Connecticut, Storrs, Connecticut, 1971.

Couto, W., et al., "Factors Affecting Oxidation-Reduction Processes in an Oxisal with a Seasonal Water Table," Soil Sci. Soc. Am. J., pp. 1245-1248, 1985.

Eastburn, R.P. and W. F. Ritter, "Denitrification in Onsite Wastewater Treatment Systems-A Review," ASAE Pub. 07-85, pp. 305-313, ASAE, St. Joseph, MI, 1985.

Hagedorn, C. et al., "The Potential for Groundwater Contamination from Septic Effluents," J. Environ. Qual. 10:1-8, 1981.

Hori, D.H., N.C. Burbank, Jr., R.H.F. Young, L.S. Lau and H.W. Klemmer, "Migration of Poliovirus Type 2 in Percolating Water Through Selected Oahu Soils, Technical Report No. 36," Water Resources Research Center, University of Hawaii, Honolulu, Hawaii, January 1970.

Kaplan, O.B., Septic Systems Handbook, 2nd Ed., Lewis Publishers, 1991.

Koizumi, M.K., N.C. Burbank, L.S. Lau, "Infiltration and Percolation of Sewage Through Oahu Soils in Simulated Cesspool Lysimeters, Technical Report No. 2," Water Resource Research Center, University of Hawaii, Honolulu, HI, August 1966.

Kreissl, J.F., "Management of Small Waste Flows," EPA-600/2-78-173, September 1978.

Laak, R., "Nitrogen and Phosphorous Removal in a Septic Tank and a Lagoon, Experimental Investigation of Nitrogen and Phosphorous Removal at the University of Connecticut Research Station," University of Connecticut, Storrs, CN, July 1974.

McGauhey, P.H., G.A. Rohlich and E.A. Pearson, Eutrophication of Surface Waters-Lake Tahoe, Bioassay of Nutrient Sources, First Progress Report, Fed. Water Poll. Control Assoc. Grant No. WPD-48, Lake Tahoe Area Council, South Lake Tahoe, CA, May 1968.

McGinnis, J., and F. De Wall, "The Movement of Typhoid Organisms in Saturated Permeable Soil." J. Am. Water Works Assoc. 75:266-271, 1983.

Mote, C.R., J.W. Kleene, J.S. Allison, "On-site Domestic Wastewater Renovation Utilizing a Partially Saturated Sand Filter for Nitrogen Removal and a Lawn Sprinkler for Effluent Discharge," Proceedings of the Seventh International Symposium on Individual and Small Community Sewage Systems, December 1994.

Nilsson, P., Infiltration of Wastewater, an Applied Study on Treatment of Wastewater by Soil Infiltration. Dissertation. CODEN:LUTVDG/TVVA 90/1002, Department of Environmental Engineering, Lund Institute of Technology, S-221 00 Lund, Sweden, 1990.

Oberdorfer, J.A., F.L. Peterson, Wastewater Injection Well Problems, Processes and Standards, Technical Report No. 146, Water Resources Research Center, University of Hawaii at Manoa, Honolulu, HI, December 1982.

Otis, R.J., "Demythologizing the Septic Tank," Proceedings of the Sixth National Symposium on Individual and Small Community Sewage Systems, December 1991.

Parsons, F., "Incidence of Virus in Ground-Water Receiving Septic Tank Effluent," MS Thesis, University of Miami, FL, 1973.

Pell, M, F. Nyberg and H. Ljunggren, "Microbial Numbers and Activity During Infiltration of Septic-Tank Effluent in a Subsurface Sand Filter," Water Res. 24:1347-1354, 1990.

Pell, M., Microbiology and Nitrogen Transformations in Sand-Filter Systems for Treatment of Household Septic-Tank Effluents, Report 48, Swedish University of Agricultural Sciences, Department of Microbiology, Uppsala, Sweden, 1991.

Perkins, R., "Septic Tanks Lot Size and Pollution of Water Table Aquifers," J. Environ. Health 56:298-303, 1985.

Pitt, W.A.J., Jr., H.C. Mattraw, Jr., and H. Klein, Ground-Water Quality in Selected Areas Serviced by Septic-Tanks, Dade County, Florida, U.S. Geological Survey, Open File Report 75-607, Miami, FL, 1975.

Romero, J.C., "The Movement of Bacteria and Viruses Through Porous Media," Ground Water, 48:37-48, 1970.

Ronner, A.B., and A.C.L. Wong, "Microbial Clogging of Wastewater Infiltration Systems," Proceedings of the Seventh International Symposium on Individual and Small Community Sewage Systems, December 1994.

Sikora, L., et al., "Septic Nitrogen and Phosphorus Removal Test System," Ground Water, 14:309-314, 1976.

Tasato, G.T. and G.L. Dugan, Leachate Quality from Lysimeters Treating Domestic Sewage, Technical Report No. 131, Water Resources Research Center, University of Hawaii, Honolulu, Hawaii, April 1980.

U.S. Environmental Protection Agency, Design Manual, Onsite Wastewater Treatment and Disposal Systems, October 1980.

Vaughn, J.M., and E.F. Landry, "Viruses in Soils and Groundwaters" in Viral Pollution of the Environment, pp.163-210, G. Berg, Ed. CRC Press, 1983.

Whitmeyer, R.H., R.A. Apfel, R.J. Otis, and R.L. Meyer, "Overview of Individual Onsite Nitrogen Removal Systems," Proceedings of the Sixth National Symposium on Individual and Small Community Sewage Systems, December 16-17, 1991.

Winneberger, J.T., Septic Tank Systems, A Consultant's Toolkit, Ann Arbor Science, 1984.

Winneberger, J.T., A.B. Menar, and P.H. McGahey, "A Study of Methods of Preventing Failure of Septic-Tank Percolation Fields, Third Annual Report," Sanitary Engineering Research Laboratory Report No. 63-9, University of California, Berkeley, December 22, 1963.

1
2
3
4
5
6
7
8
9
10
11
12
13
14
15
16
17
18
19
20
21
22
23
24
25
26
27
28
29
30
31
32
33
34
35
36
37
38
39
40
41
42
43
44
45
46
47
48
49
50
51
52
53
54
55
56
57
58
59
60
61
62
63
64
65
66
67
68
69
70
71
72
73
74
75
76
77
78
79
80
81
82
83
84
85
86
87
88
89
90
91
92
93
94
95
96
97
98
99
100

Appendix D

Groundwater Investigation Report

FINAL REPORT

to

Hawaii Pacific Engineers, Inc.

**Assessment of Nitrogen and Microbial Contributions
of Waimanalo "Beach Lot" Cesspool Systems
to Groundwater**

March, 1997

Daniel J. Hoover
Tua M. Unutoa
Dr. A.I. El-Kadi, Principal Investigator
Dr. Roger Fujioka, Co-Principal Investigator

University of Hawaii at Manoa

EXECUTIVE SUMMARY

This project was initiated to quantify groundwater fluxes of nitrogen and microbial contaminants from cesspools in the Waimanalo "beach lot" neighborhood to Waimanalo Bay. To estimate these fluxes, we analyzed groundwater quality and well head data from four monitoring wells within, and inland of, the beach lot region. Head fluctuations provided information on local geohydrologic parameters and on the degree to which the monitored wells were hydraulically connected. Water sample analyses provided data on the absolute concentrations of chemical species and microbial populations.

In general, we expected groundwater to flow predominantly toward the ocean, with groundwater in the two mauka wells representing water unaffected by cesspool loading, and water in the two makai wells showing the accumulated effects of cesspool inputs of nitrogen and microbes. Two wells were installed and monitored in the mauka and makai regions to provide replication of conditions in each of these areas. Surprisingly, the results obtained in this study demonstrate that groundwater in the study area does not appear to flow directly from the mauka to makai wells, and that in fact the aquifers sampled by the mauka and makai wells may not be hydraulically connected to any significant degree. As a result, we were unable to use the data obtained in this study to estimate nutrient and microbial fluxes to coastal waters in the manner originally intended.

Despite our inability to directly quantify fluxes, the data provided by this study do allow us to reach some tentative conclusions regarding the probability of nutrient and pathogen delivery to coastal waters. Overall, it appears that the potential for denitrification, which is the only process capable of permanently removing cesspool nitrogen from groundwaters, is relatively small. As a result, the bulk of groundwater nitrogen probably does reach coastal waters. Microbial transport appears to be less likely, as groundwater sampled within the beach lot region was only occasionally found to contain measurable levels of indicator organisms, suggesting that the sandy soils in the beach lot region may be relatively efficient at filtering bacteria from cesspool effluent. Better quantification of the actual magnitude and pathway(s) of cesspool nitrogen delivery to coastal waters, and of the overall risk of pathogen delivery to coastal waters can be obtained by monitoring additional wells in the beach lot region. Additional wells in the mauka region would also resolve flow details in that region and allow an integrated assessment of groundwater nitrogen transport in this portion of the Waimanalo watershed. Given the apparent complexity of groundwater flow in the region, and the variety of sources that may be affecting groundwater nitrogen levels, additional study is required to adequately characterize the magnitude and importance of cesspool nutrient and pathogen contributions to groundwater.

TABLE of CONTENTS

EXECUTIVE SUMMARY	ii
TABLE of CONTENTS	iii
LIST of FIGURES	iv
LIST of TABLES	v
BACKGROUND	1
APPROACH	2
FIELD and LABORATORY METHODS	3
<u>Well Head Monitoring</u>	3
<u>Temperature/Oxygen Profiles</u>	3
<u>Water Sampling and Analysis</u>	3
Nutrients	3
Physical and Microbiological Parameters	4
RESULTS and DISCUSSION	6
<u>Well Heads</u>	6
Subsurface Geology	7
<i>Vertical Inhomogeneity</i>	8
<i>Lateral Inhomogeneity</i>	8
Spatially-Variable Infiltration	10
<u>Temperature/Oxygen Profiles</u>	11
Mauka vs. Makai Wells	12
Mauka Well Differences	13
Makai Well Differences	13
<u>Groundwater Quality</u>	13
Nutrients	13
<i>Nitrogen</i>	14
<i>Phosphorus</i>	16
<i>Total Organic Carbon</i>	17
<i>Silica</i>	17
Physical Parameters	18
Microbiological Parameters	19
CONCLUSIONS and RECOMMENDATIONS	23
REFERENCES	25
APPENDIX A: Temperature/Oxygen Data and Profiles	58
APPENDIX B: Nutrient Data	93

LIST of FIGURES

Figure 1. Waimanalo watershed and monitoring well locations.	27
Figure 2. Waimanalo well heads.	28
Figure 3. Groundwater heads across the MW-1/3 transect.	29
Figure 4. Tidal fluctuations in Waimanalo Bay and MW-3 response.	30
Figure 5. Pre- and post-storm temperature and dissolved oxygen profiles.	31
Figure 6. Geologic section through the study area.	35
Figure 7. Geologic map of the study area.	36
Figure 8. Temperature and dissolved oxygen profiles.	37
Figure 9. Pre- and post-storm nutrient depth profiles.	41
Figure 10. Depth profiles of silica, total organic carbon, total nitrogen and total . phosphorus.	45
Figure 11. Depth-averaged nutrient concentrations over the study period.	49
Figure 12. Silica levels in frozen and refrigerated samples.	53

LIST of TABLES

Table 1. Water samples collected from Waimanalo monitoring wells.	54
Table 2. Waimanalo head data.	55
Table 3. Bacteriological and physical data for Waimanalo monitoring wells.	56
Table 4. Geometric mean concentrations of fecal indicator bacteria and F-RNA bacteriophage recovered from various sources in Hawaii.	57

BACKGROUND

Groundwater-borne nutrients (nitrogen, phosphorus, and silica) and pathogens (bacteria and viruses) can have significant negative effects on coastal waters, particularly when changes in nutrient fluxes alter receiving ecosystems, and when pathogens affect organisms in the receiving waters, including humans.

Nutrients are present in natural groundwaters at variable levels, depending on the nature of the soil and rock that the groundwater passes through enroute to the ocean. When natural lands are developed, nutrient loads in groundwaters generally increase. Nitrogen levels in particular often increase dramatically due to inputs from agricultural fertilizers or on-site wastewater treatment systems (cesspools and septic tanks). Pathogens are generally not present in significant concentrations in natural groundwaters, as inputs are dispersed and soils are normally effective filters. Where inputs are concentrated and/or soils are ineffective at retaining these organisms, groundwater may become an effective conduit for pathogen delivery to coastal waters (Hagedorn 1984). In the Waimanalo watershed, there are a number of activities that may be contributing nutrients and pathogens to groundwater, which in turn may be affecting the Waimanalo Bay ecosystem and water quality. We were asked to specifically address the issue of nitrogen and microbial inputs to groundwater from cesspools in the Waimanalo "beach lot" region (Figure 1).

Cesspools in this region are a concern because of their close proximity to the ocean and because cesspools in many other areas have been shown to be significant sources of contamination to groundwaters (Rail 1989). As a result, current state and federal regulations prohibit the installation of new cesspools in most areas. In particular, current State of Hawaii regulations (Department of Health 1996) prohibit or seriously limit the installation of new cesspools in the State. However, many cesspools installed prior to current restrictions are still in use, including over 1000 in the Waimanalo region, roughly 300 of which are located in the beach lot region.

APPROACH

To assess groundwater flow and cesspool nutrient loading in the beach lot region, a three month monitoring and sampling program was conducted starting on October 24, 1996 and ending on January 19, 1997. Heads in four shallow (20 - 25') monitoring wells (Figure 1: MW-1, -2, -3, -4) were measured on 16 occasions (Figure 2) and well-water samples were collected for microbiological and nutrient analyses on 7 occasions (Table 1). Microbiological analyses included assays for fecal coliform, *E. coli*, enterococci, *C. perfringens*, total heterotrophic bacteria, and F-RNA bacteriophage, as well as physical parameters (pH, turbidity and salinity). Nutrient analyses included nitrate + nitrite ($\text{NO}_3 + \text{NO}_2$, henceforth referred to as nitrate or NO_3), ammonium (NH_4), total nitrogen (TN), phosphate (PO_4), total phosphorus (TP), total organic carbon (TOC), and silica (Si). Dissolved organic nitrogen (DON) and dissolved organic phosphorus (DOP) were calculated by difference from measured species ($\text{DON} = \text{TN} - \text{NO}_3 - \text{NH}_4$, $\text{DOP} = \text{TP} - \text{PO}_4$). Head monitoring generally included determination of depth profiles of temperature and dissolved oxygen (T/O_2) using a portable probe.

Monitoring well locations were chosen based on the assumption that the general direction of groundwater flow in the region would be toward, and roughly perpendicular to, the coast. Within the study region, the residential area makai of Kalaniana'ole Highway is completely unsewered (100% cesspools), while the narrower area mauka of the highway is roughly 70% sewerded (~30% cesspools). Within the latter region, wells MW-1 and MW-2 were located mauka of known cesspools and thus were expected to provide replicated sampling of groundwater unaffected by cesspool inputs, while the coastal location of wells MW-3 and MW-4 was expected to provide replicated sampling of groundwaters that had accumulated nutrients and pathogens in transit from MW-1 and MW-2.

To quantify rates of contaminant accumulation and subsequent discharge to the ocean, we planned to use a two-dimensional model (SUTRA) to simulate groundwater flow and chemical transport based on head, transmissivity, and nitrogen data from the field study. Flow in this type of model occurs only in a vertical cross-section that is assumed to be representative of all mauka-makai cross-sections in the study area. As will be shown later in this report, local subsurface heterogeneities clearly produce substantial variability in the subsurface flow field, to such a degree that a simple two-dimensional model could not be used to predict nutrient transport in the study area. In addition, an apparent discontinuity in groundwater flow between mauka and makai regions prevented us from determining even the local components of flow in the mauka and makai regions. As a result, we were unable to estimate the three-dimensional flow field, and modeling was abandoned as part of this study.

FIELD and LABORATORY METHODS

Well Head Monitoring

Well heads were initially measured only approximately, based on visual contact of the T/O₂ probe, or using a piezometer that performed erratically and ultimately failed. As a result, early head measurements (11/21 and before) are probably only accurate to within ± 1 to 2 cm. After 11/21, heads were measured visually using a tape measure, with accuracies of ± 2 to 4 mm depending on down-well visibility, with precision improving after 12/6 due to increased efforts to quantify the difference in heads between MW-3 and MW-4. When water samples were collected, well heads were measured both before and after collection. Heads in one mauka and one makai well (MW-1 and MW-3) were monitored continuously by MGD Technologies, Inc. (MGD) for a 7 day period at the start of the study (MGD Technologies Inc. 1996), and we monitored the two makai wells (MW-3 and MW-4) semi-continuously for about 8 hours on 12/14 to obtain additional tidal response data.

Temperature/Oxygen Profiles

Temperature/Oxygen (T/O₂) profiles were obtained in the field using a YSI Model 58 Dissolved Oxygen Meter. Temperature and oxygen measurement precisions were 0.1°C and 0.1 mg/l, respectively. Prior to each set of measurements the probe membrane was inspected for damage or air bubbles, replaced if necessary, and the probe calibrated. At each well, the probe was lowered first to a point above the water surface to obtain an air temperature and oxygen saturation reading. Within the water column, readings were taken at one to two foot intervals to the bottom of the well. At each depth, the probe was agitated slightly to avoid excessive oxygen depletion at the membrane, and T/O₂ values recorded when the oxygen reading changed less than 0.1 mg/l over approximately a 15 second period. Measurements at each depth were repeated during probe recovery to assess both the accuracy of initial "descending" measurements and the effects of probe passage and associated mixing on the well water column. On dates when water samples were collected, T/O₂ data were collected both before and after sample collection.

Water Sampling and Analysis

Nutrients

Water samples were obtained using one of three pumping systems. A compressed-air driven bladder pump was used at MW-4 on 10/24, but was replaced by a peristaltic pump at MW-2 when the bladder pump failed. On subsequent dates, one of two peristaltic pumps was used. All of the pumping systems used polyethylene tubing for sample collection.

Water samples were collected from predetermined depths into acid-washed polyethylene sample bottles. Before collecting samples at each depth, pump tubing was flushed by pumping approximately 1.5 liters into a waste bucket. After the tubing had been flushed, sample bottles were rinsed five times with sample water before filling. Nutrient samples were collected in 125 ml bottles, and then split by using the 125 ml sample to partially fill a matching 60 ml bottle. Both bottles were then tightly capped and stored on ice until returned to the laboratory, where the 125 ml bottle was frozen and the 60 ml bottle refrigerated for later analysis.

Nutrient analyses were performed on thawed 125 ml samples in the SOEST Analytical Services Laboratory using standard methods (APHA, AWWA & WPCF 1995) modified for the Technicon Autoanalyzer. Refrigerated 60 ml samples were used for precision silica (Autoanalyzer) and salinity (precision salinometer) analyses.

Physical and Microbiological Parameters

Physical and microbiological analyses were performed on four one-liter samples collected from one depth in each well (Table 1). Samples were collected into sterile bottles that had been triple-rinsed with sample water prior to sample collection. Samples were then packed on ice for transport to the Water Resources Research Center (WRRC) and analyzed within six hours of collection.

For physical parameters, salinity (‰), pH (pH units), and turbidity (NTU) were measured using a refractometer, pH meter, and turbidimeter respectively.

Microbiological analyses used a variety of methods. The membrane filtration procedure as specified in the Standard Methods for the Examination of Water and Wastewaters (APHA, AWWA & WPCF, 1995) was used to assay for fecal coliform (FC) on mFC medium, *E. coli* (EC) on mTEC medium, enterococci (ENT) on mE medium, total heterotrophic bacteria (HPC) on mHPC medium and *C. perfringens* (CP) using the procedure and mCP medium described by Bisson and Cabelli (1979). Incubation temperatures and periods for each assay were 44.5°C for 24 ± 4 hrs (FC and EC); 41°C for 48 ± 4 hrs (ENT); 45°C for 24 ± 4 hrs (CP); and 35°C for 24 ± 4 hrs (HPC). Water samples were generally observed to be very clear, thus to increase the sensitivity of the assays, 500 ml of well water samples were filtered through two filters, concentrations of bacteria on both filters were counted, and results are reported as CFU/1000 ml. For total heterotrophic bacteria assays, well water samples were initially diluted before filtration to obtain reasonable counts on membranes. Analysis of F-RNA bacteriophage used both the direct and concentration methods described by DeBartolomeis and Cabelli (1991) using the *E. coli* host strain HS (pFamp) R. Since bacterial levels in the wells were negative to low in 1000 ml water samples, and only 100 ml of samples could be assayed for F-RNA phage, this assay

was discontinued after the first two sampling dates. Results for F-RNA bacteriophage concentrations are reported in plaque-forming units (PFU) per 100 ml of water.

RESULTS and DISCUSSION

Well Heads

The earliest reliable head data are the time series obtained by MGD. These data show a clear response of the makai head (MW-3) to tidal forcing (Figure 2), with an amplitude of about 0.15 m, or about 25% of the corresponding tidal range in Waimanalo Bay, and a phase delay of about 2 hours relative to bay tides. Simultaneous monitoring of MW-3 and MW-4 on 12/14 showed a similar result in MW-3, but showed that the tidal response in MW-4 was slightly more damped, with an amplitude of about 16% of the Bay tidal range. The mauka well in the MGD time series (MW-1) exhibited a very small diurnal fluctuation (~0.6 cm) superimposed on an approximately linear trend, with the mean well head increasing ~1.3 cm over the 6 1/2 days of measurements (see plot in MGD Technologies Inc. 1996). The fluctuation in this well was not tidal, as there was no change in phase from day to day. We have not attempted to determine the exact source of the variation, but it seems likely that it was associated with diurnal temperature and/or atmospheric pressure fluctuations.

One of the surprising features of the MGD dataset is the difference in mean head between the mauka and makai wells, where the makai well head was roughly 4 cm higher, on average, than the mauka well (Figures 2 and 3). This difference is in the opposite direction to that which would be expected for groundwater flow from the land to the ocean. In this case, it appears that the extended dry period prior to these measurements resulted in substantial lowering of groundwater heads in the watershed, except in the beach lot region which receives relatively continuous recharge in the form of cesspool effluent. Preliminary calculations suggest that cesspools provide the equivalent of about 20" of recharge annually, a significant amount compared to natural rainfall recharge, which probably is on the order of 15 - 20" annually (assuming recharge of ~40% of average annual rainfall of ~40 - 45") and is concentrated in the winter months. This recharge component could also help to explain the generally elevated heads in the beach lot wells, which are about 0.6 m above Mean Sea Level (MSL), despite being only about 100 m from the ocean (Figure 3).

A major storm occurred in the watershed from 11/13 to 11/17, resulting in significant increases in mauka well heads (Table 2, Figures 2 and 3). After the storm, mauka well heads declined exponentially until 12/27, when a smaller storm produced another slight increase. After 12/27 mauka heads fluctuated predictably in response to a series of small to moderate storm inputs. In contrast, makai heads stayed within a very narrow range throughout the study period, with a relatively constant but small gradient (~3 cm) between the wells (Table 2). The range of measured heads matched closely the tidal response range recorded in the MGD monitoring of MW-3 and in our monitoring of MW-3 and -4.

To assess the degree to which tidal fluctuation might contribute to apparent changes in makai heads, we used the MW-3 attenuation and phase shift results from the MGD time series (25% and 2 hrs) and applied them to Waimanalo Bay tides during the study period to predict tidal variation in MW-3 on days when the head was measured (Figure 4). In general, the measured head agrees with the predicted tidal response to within about 10 cm, a difference that can easily be accounted for by the inaccuracy of the tidal response estimate and by changes that should be produced by direct infiltration of rainfall in the region. Thus, differences in makai heads on different days appear primarily to be due to sampling during different phases of the tidal cycle, and the relatively constant gradient between the wells seems likely to represent a near-steady-state balance between local cesspool recharge and effluent flow away from the recharge region. Even if there are minor trends in makai heads that are not apparent due to the inaccuracies of tidal response calculations, the lack of any visible trend in makai heads during a period when mauka heads were clearly affected suggests that there is very little hydraulic connection between the aquifers monitored by the mauka and makai wells.

While it seems clear that groundwater from the mauka region is not passing through the monitored beach lot region, it must eventually discharge to the ocean, presumably through a somewhat more circuitous path. Unfortunately, the precise direction of flow in the mauka region cannot be determined with only two well head measurements. We can conclude that there is a significant component of flow from MW-1 toward MW-2 because of the persistent and substantial post-storm head gradient between the mauka wells (Table 2, Figure 2), and the nutrient data suggest that groundwater does not flow directly from MW-1 to MW-2 (see Nutrients), but nonetheless it is still not possible to tell whether the net flow in the region is even *toward* or *away from* the ocean. However, we can attempt to define mechanisms that might produce the observed head responses by considering some of the principal factors affecting groundwater flow and the degree to which they may control groundwater flow in this region. Two that seem particularly likely to affect groundwater flow in the study region are spatial variations in subsurface geology and spatial variations in surface infiltration.

Subsurface Geology

Subsurface geology is likely to be a major control on groundwater movement in the Waimanalo region. Previous hydrologic investigations in this area have emphasized the differences between the highly permeable surface sands (0 to ~30' depth), impermeable subsurface layers of clay and alluvium, and highly permeable subsurface carbonate formations as the major controls on groundwater movement (e.g., Takasaki et al. 1969; Wilson Okamoto & Associates 1984; Harding Lawson Associates 1992). At the watershed scale, these features probably do control the gross dynamics of groundwater flow, but on smaller scales,

heterogeneity within each of these elements may have significant effects on local flow. In particular, inhomogeneity within the surface "sand" layer may constrain both vertical and lateral flow within this aquifer.

Vertical Inhomogeneity

Vertical inhomogeneity in the surface aquifer is apparent in drilling logs for the monitoring wells (Pacific Geotechnical Engineers, Inc. 1996). In particular, drilling efficiency (expressed as "blows/ft") varied significantly downhole in all of the wells, with consistent but different trends at mauka and makai wells (Figure 5). At mauka wells, drilling in surface sands required only moderate force (~20 - 50 blows/ft), dropping to 10 blows/ft or less where sands gave way to underlying silty lagoonal deposits. At makai wells, initial drilling above sea level also required only moderate force (~20 - 30 blows/ft), but drilling slowed dramatically as well depths went below sea level, requiring up to 120 blows/ft. This increase coincided with increasing density and cementation of the carbonate sand matrix (Figure 5). Compaction and cementation are likely to reduce permeability, and thus both lateral and vertical flow. Thus, the vertical inhomogeneity observed in makai wells is likely to restrict efficient vertical and lateral flow (e.g. infiltration and subsurface flow of runoff and cesspool leachate) to the above-sea level portion of the aquifer. This may also explain the rather low tidal efficiencies measured at makai wells, as the tidal signal travels primarily through the below-sea level portion of the aquifer.

Lateral inhomogeneity

Lateral inhomogeneity cannot be demonstrated directly with available data, but several lines of evidence suggest that there may be more reason to expect inhomogeneity than homogeneity. Potentially important sources of lateral inhomogeneity include natural subsurface topography, man-made barriers and conduits, and permeability gradients associated with leaching and recrystallization of carbonate sands.

Lum and Stearns (1970) analyzed a series of cores from the Waimanalo region to develop a detailed geologic cross-section of the region (Figure 6). Of particular interest is the subsurface extension of the "dune limestone" outcrop known locally as "Coral Hill". In the geologic section, the surface of the dune limestone drops from "Coral Hill" toward the coast and then rises before dropping again. This contour is similar (though attenuated, possibly by erosion) to that observed in other regions where dunes contribute to coastal development (e.g. Bermuda (Vacher 1971)). If this contour does represent an ancient dune surface, then the buried dune should be geologically younger than the dune outcropping at "Coral Hill", and the peak should approach the ground surface (dashed line, Figure 6) rather than being truncated as shown in the section. While we have not been able to locate any permeability data for dune limestone, photographs of

core sections suggest that dune limestone may be considerably denser and less permeable than either surface sands or deeper reef-carbonate structures (Lum and Stearns 1970). If this is the case, then a subsurface dune could form an efficient barrier to lateral flow through the surface sand aquifer. Present day dunes form a band parallel to the coastline, while outcrops similar to "Coral Hill" also occur along a broken but roughly linear band further inland (Figure 7). Thus it seems reasonable to expect that a buried dune ridge of intermediate age might be present and of sufficient lateral extent to produce a hydraulic discontinuity between the mauka and makai aquifers.

Man-made features may also alter subsurface flow, particularly if road construction, installation of water and sewer lines, etc. lead to laterally extensive changes in soil properties over significant depth intervals. We have not investigated this possibility to any significant degree, but one intriguing possibility is suggested by the orientation of a major sewer interceptor line in the study region. This line runs under Oluolu Street, just makai of wells MW-1 and MW-2, until Oluolu Street reaches Kalaniana'ole Highway, where it turns to follow the highway east, eventually terminating near Kaiona Beach Park (Wilson Okamoto & Associates 1984; Fukunaga & Associates, Inc. 1985) (Figure 1). The orientation of the line in the study area is nearly parallel to the coast, so that if construction methods led to a significant decrease in soil permeability along the line, it might form a barrier to groundwater flow between mauka and makai wells. Because the line then angles toward the coast, accumulated groundwater might be expected to follow the sewer line to the east, as suggested by the post-storm head gradient between MW-1 and MW-2 (Figure 2, Table 2). Interestingly, a construction-associated increase in permeability would have a similar effect on groundwater flow, as the sewer ditch would then act as a drain, diverting mauka groundwater and channeling it toward the Waimanalo and Kaiona Beach Park areas. Unfortunately it is difficult to determine the degree to which this type of mechanism might affect groundwater flow because we have no data on the degree of permeability changes that might result from the installation. The installation trench was probably at least 3 to 4 feet wide, and standard construction methods dictate the use of coarse fill in the bottom of the trench, which would provide a low-permeability path. However, the bulk of the backfill used was probably native material, which in the Waimanalo region would likely be sands removed during the initial excavation. Excavation would probably tend to disaggregate soils and increase permeability to some degree, and would certainly enhance permeability in regions that might have contained partially cemented or lithified sands. In addition, the depth range affected is quite large – "as built" drawings show that the interceptor line is roughly 20' below ground (and several feet below sea level), and soil borings taken along Oluolu Street show that permeable sands (i.e. the surface aquifer) only extend to about 20' below ground in this region (Fukunaga & Associates, Inc., 1985). Thus, while it is not possible to quantify the

magnitude of an effect in this case, it seems possible that this type of installation might have a significant effect on local groundwater flow.

Carbonate leaching and recrystallization is a natural process that is likely to produce lateral changes in permeability as well as the vertical changes mentioned previously. Leaching occurs when fresh water percolates through carbonate sands or limestone rock, because natural fresh waters are generally highly undersaturated with respect to carbonate minerals. However, as the water continues to pass through the sand or rock and concentrations of dissolved constituents increase, the solution becomes progressively less undersaturated. Eventually, the solution will become saturated and then supersaturated, leading to carbonate recrystallization at a location substantially down-gradient from the point of dissolution. In coastal environments this process is likely to be accelerated by the fact that groundwater becomes progressively more saline as it moves toward the ocean. Because surface ocean water is normally saturated or supersaturated with respect to carbonate precipitation, groundwater mixing with ocean water should reach saturation quite rapidly, leading to preferential recrystallization in the salinity transition zone. Thus, we would expect vertical permeability in the beach lot region to decrease relatively rapidly at or below a depth corresponding to the maximum height of tidal influence, as is observed in well logs, and we would expect lateral permeability to decrease rapidly toward the coast in the region where fresh water from the beach lot region discharges to the ocean. If recrystallization in the salinity transition zone is extensive, lateral flow will be impeded and groundwater levels will rise, shifting discharge into more permeable overlying sands. Over time, continuing recrystallization and groundwater "overflow" should eventually lead to groundwater levels that are effectively perched at levels significantly higher than mean sea level, much like the groundwater levels observed in the beach lot region.

Spatially-Variable Infiltration

The second factor that is likely to affect local groundwater flow is variation in the spatial distribution of surface infiltration. Spatial variability may be produced by the concentrating and dispersing effects of natural topography, or by natural or anthropogenic features affecting permeability of the land surface, such as variations in surface soil properties or the addition of paved areas and buildings.

Topography is clearly important in distributing runoff in the Waimanalo region, producing extensive shallow pools of standing water in low-lying areas after even moderate rains. Because infiltration is then concentrated in these areas, recharge should vary spatially in a predictable manner. This variability would then lead to local effects on groundwater flow, because focused infiltration would lead to a local rise in the underlying groundwater table, which would then act to redistribute recharge to local groundwater "lows", which in turn would occur under local

topographic "high". Thus, the instantaneous groundwater table should tend to mirror surface topography after a rain event (cf. Swain and Huxel 1971). In general, this effect will be transient and probably unimportant on large scales where flow is controlled primarily by gradients associated with the distribution of rainfall or large scale topography, such as the flow of groundwater from the mountains toward the ocean. However, on smaller scales and where major gradients do not control flow, topography may exert significant control over local groundwater flow.

In the study area, we observed significant topographic concentration in the areas adjacent to both MW-1 and MW-3. For instance, the undeveloped land immediately mauka and west of MW-1 is a significant local topographic low. As a result, runoff from the surrounding area converges on the low, which then becomes the focus of infiltration to groundwater. It appears that the groundwater table may actually rise above the land surface in this area, as post-storm groundwater levels in MW-1 rose to within about 4' of the ground surface, and the ground surface is several feet higher than the lowest point in the topographic low. In fact, residents advised us that the region floods frequently to depths of several feet, with depths occasionally reaching six feet or more. This type of flooding has been observed previously in a similar coastal community in the Kailua region (Swain and Huxel 1971). Concentrated recharge may thus contribute to the head gradient observed between MW-1 and MW-2, although it seems likely that the persistence and magnitude of the observed gradient require larger scale forcing than that produced by transient infiltration effects. In the MW-3 region, topographic concentration is not as pronounced, but may also contribute to the persistent elevation of the MW-3 head relative to MW-4, which is located at a local topographic "high".

Spatial variations in surface permeability are also clearly important in the Waimanalo region. Extensive development has replaced large areas of previously permeable soil with impermeable roads, parking lots, and roofed structures. While these changes affect infiltration directly only on the scale of individual structures, a more important indirect effect may be the concentrating effect it has on runoff and the subsequent accumulation of runoff in topographic lows. Thus the natural concentrating effect of topography is probably amplified considerably over natural levels, leading to concomitantly increased effects on local groundwater flow. This effect may be particularly pronounced near the mauka wells, because study area elevations are actually highest just mauka of the makai wells, where dunes are presently forming, with elevations sloping gently downward from the dune peaks to a low point just mauka of MW-1 and MW-2 (Figure 6).

Temperature/Oxygen Profiles

Temperature/oxygen (T/O₂) profile data (Figure 8, Appendix 1) were collected primarily to obtain insight into the degree of stratification or mixing present in each of the wells.

Temperature profiles are probably more robust for this purpose than oxygen profiles, as temperature gradients across the air-water interface within the well are generally modest and undergo a diurnal cycle, preventing the water column from accumulating a strong air temperature bias. Oxygen profiles can also provide evidence of stratification, but oxygen levels can be affected relatively rapidly and significantly by well and sampling artifacts. To some degree, sampling procedures can probably affect low-oxygen waters simply by mixing well waters with overlying air during insertion and removal of sampling equipment. This may be the reason for a relatively consistent, post-sampling increase in makai well oxygen levels (e.g., Figure 5(d), 11/6 profiles). However, we also observed cases where relatively high oxygen levels increased slightly following sampling, a phenomenon that we are unable to explain (e.g., Figure 5(d), 11/21 profiles). More commonly, it appears that low oxygen levels in groundwaters lead to significant diffusive uptake of oxygen from the air column above the well during the period between samplings, producing dissolved oxygen levels substantially higher than those found in groundwater surrounding the well. The degree to which diffusive uptake will affect measured dissolved oxygen levels will depend both on the oxygen gradient at the air-water interface and on the residence time of water in the well. Strong gradients promote rapid uptake, which will lead to significant increases in measured dissolved oxygen, particularly if residence times are long. Conversely, small gradients and short residence times both tend to minimize uptake artifacts in dissolved oxygen measurements. Examples of this type of artifact can be seen in MW-2 on 11/21 (Figure 5(b)), where sampling lowered oxygen levels by more than 1 mg/l, and in MW-1 on 12/6 (Appendix 1), where sampling lowered levels by several mg/l. We did not attempt to purge wells specifically for the purpose of determining true background oxygen levels, thus oxygen profiles obtained in this study should be interpreted cautiously. However, despite the potential problems inherent in these measurements, certain overall patterns in both temperature and oxygen profiles can be related both to differences between the mauka and makai wells, and to differences between individual mauka and makai wells.

Mauka vs. Makai Wells

Mauka wells are less vertically-mixed (more stratified) than makai wells, as evidenced by the near-vertical temperature profiles in makai wells and the significant slopes in mauka profiles. This is likely due to the mixing effect of cyclic tidal forcing in the makai wells. Mauka wells also showed evidence of storm-induced stratification following the 11/13-17 storm, with a layer of cool, high-oxygen water at the surface.

Mauka Well Differences

Prior to the 11/13-17 storm, both mauka wells had uniformly low oxygen concentrations (generally less than 1 mg/liter, vs. saturation levels on the order of 8 mg/l). After the storm, both wells displayed oxygen levels of 4 to 6 mg/l in the surface layer, but MW-1 (the up-gradient well) maintained consistently higher maximum oxygen levels than MW-2, as well as significant oxygen levels near the bottom of the well, while oxygen levels in MW-2 dropped rapidly below the surface layer. There is also a temperature offset between the wells, with MW-1 consistently ~ 0.2°C cooler than MW-2 during the period after the storm, and 0.2 - 0.8 °C cooler before the storm.

Makai Well Differences

Both temperature and oxygen profiles show that MW-3 is consistently less stratified than MW-4. This is consistent with the reduced tidal forcing in MW-4 suggested by the tidal response data of 12/14 (Figure 2). Oxygen levels in both wells were elevated slightly following the 11/13-17 storm, with the highest levels observed in MW-4. This feature also probably results from the difference in tidal mixing efficiencies, with infiltrating high-oxygen stormwater being mixed downward more slowly in MW-4 than in MW-3.

Groundwater Quality

Nutrients

Nutrient sampling and analysis was designed primarily to obtain the data necessary to estimate nitrogen concentrations in groundwaters. However, we also analyzed samples for phosphorus, total organic carbon, and silica to obtain supporting data relevant to determining possible sources of the nitrogen, its potential importance as a nutrient in coastal waters, and the potential for denitrification. To ensure that measurements were not affected significantly by sampling procedures, we also performed initial checks on between-sample variability, pumping effects, and on the depth distribution of nutrients in the wells.

Sampling on 11/6 included replication of all samples, a pumping effects test at one well (MW-2), and samples from two depths in two wells (MW-1 and MW-3). Results indicated that replicate samples were effectively identical and that pumping produced only minor changes in sample chemistry, but that nutrients might vary significantly with depth (Appendix 2, Figure 9). Because of the limited funds available for sample analysis, replication was discontinued and sampling procedures were revised to obtain a series of samples at different depths from each well instead. The actual depths sampled varied somewhat on different dates as water levels fluctuated and as nutrient data became available for evaluation (Table 1). In particular, samples on 11/21 and 11/24 were collected to reproduce depths sampled on 11/6, with additional samples collected

to characterize potential gradients associated with the recent input of stormwater. After 11/24, data suggested that gradients were not pronounced (Figure 10), so some sampling depths were eliminated and only two samples were analyzed initially from each well. Complete nutrient data are tabulated in Appendix 2; depth profiles of silica, TOC, TN, and TP are shown in Figure 10, and time series plots of depth-averaged nutrient concentrations in each well are shown in Figure 11.

Nitrogen

Nitrogen in sampled groundwater occurred primarily as nitrate, with minor contributions from ammonium and organic nitrogen (Figure 11, Appendix 2). Total nitrogen concentrations varied considerably among the four wells, from less than 50 μM (0.7 mg/l) at a mauka well (MW-2) to over 3000 μM (42 mg/l) at a makai well (MW-4). The latter concentration is comparable to that expected in undiluted effluent, while the former is similar to levels observed in high-level dike-impounded groundwater, or about twice the levels expected in rainwater (Hoover et al., in prep). Surprisingly, the other mauka well (MW-1) displayed the second-highest nitrogen concentrations, exceeding 1000 μM (14 mg/l), while the other makai well (MW-3) contained up to 500 μM (7 mg/l) total nitrogen. In all of the wells, total nitrogen concentrations after the 11/13-17 storm were on the order of two times higher than pre-storm concentrations. In the mauka wells, levels remained elevated for the duration of the study period, while nitrogen levels in the makai wells declined in the latter part of the study period.

We expected groundwater nitrogen concentrations to vary in a predictable pattern, with relatively uncontaminated levels in mauka wells and high levels in makai wells. The makai wells did show elevated nitrogen levels, but of very different magnitudes. This may be due to differences in dilution produced by the importance of local infiltration at MW-3 relative to MW-4, and to differences in the efficiency of tidal mixing in the wells, as has previously been discussed. Variable dilution and infiltration-driven changes in the direction and strength of flow of effluent from cesspools (see Microbiological Parameters) may also contribute to the post-storm increase and subsequent decrease seen in makai well nitrogen levels. However, the difference in the mauka wells is clearly not due to a tidal mixing effect and seems unlikely to be a dilution effect given the extremely low nitrogen levels in MW-2. In addition, the dramatic and persistent difference in nitrogen levels between MW-1 and MW-2 clearly indicates that groundwater is not flowing directly from MW-1 to MW-2, thus it seems probable that the difference reflects distinct upstream nitrogen sources. Nitrogen levels in MW-2 are probably adequately explained by natural leaching from soils, so the remaining issue is the source of the nitrogen observed in MW-1.

Several potential sources for the nitrogen observed in MW-1 can be considered, including the cesspools remaining in the mauka region, the Waimanalo Sewage Treatment Plant, agricultural activity in the watershed, and natural soil sources. The sewage treatment plant seems to be the least likely candidate, as the plant injection wells are roughly 200 feet deep, and are solid cased to depths of 70 to 100 feet, forcing effluent into a deep carbonate formation that is extremely unlikely to be hydraulically connected to the shallow groundwater sampled by MW-1 (Figure 6). Thus, barring a major failure in the injection process, this is very unlikely to be the source of the observed nitrogen. We have determined that there are cesspools in the area around the mauka wells, however the closest cesspool that could conceivably be upgradient of MW-1 is located approximately 120 feet away, and is roughly 80 feet makai of the well. Thus, for this cesspool to be the source of the observed nitrogen, local flow would have to be significantly mauka, or the plume of cesspool contamination would have to extend significantly across or up the flow gradient. Both of these scenarios are possible, but seem relatively unlikely given the strong flow component from MW-1 toward MW-2 observed throughout the post-storm period.

The more likely candidates seem to be agricultural sources and natural soil inputs. Both of these sources could provide significant inputs of nitrogen to groundwater, and would also be consistent with the persistent elevation of post-storm nitrogen levels in both mauka wells. Both sources require soil nitrogen to be leached from surface soils to the water table, a process that requires soil moisture levels sufficient to maintain transport from the unsaturated to saturated zone. Soil moisture levels prior to the 11/13-17 storm were probably too low to support leaching, while levels following the storm were certainly adequate and may well have remained sufficient throughout the study period.

Agricultural activities lead to mineralization and leaching of soil organic nitrogen to groundwater, and fertilizer use frequently results in substantial nitrogen leaching to groundwater. For instance, our analysis of nitrogen cycling at the state level suggests that a good working estimate may be that around 25% of fertilizer nitrogen is leached to groundwater (Hoover et al., in prep). Fertilizer application rates in Hawaii vary from around 200 lbs N/acre/y for crops like sugar cane to values exceeding 1000 lbs/y for some vegetable crops (Dr. C. Evenson, UH Dept. of Agronomy and Soil Science, pers. comm.). We cannot perform a detailed estimate of the potential for agricultural nitrogen loading to Waimanalo groundwater without information on the types of crops being cultivated and the associated fertilizer practices, but if we assume that half of the roughly 1400 acres of agricultural land in the watershed are receiving fertilizer at the conservative lower rate of 200 lb/y, then the associated input to groundwaters might be on the order of 70,000 lbs N/y. Cesspools in the watershed probably process on the order of 40 - 50,000 lbs of nitrogen per year (assuming between 1000 and 1,300 cesspools in the watershed, 4 users per cesspool, and nitrogen inputs of ~11 lbs N/person/y) with the beach lot region (~320

cesspools) accounting for about 13,000 lbs of the total. Thus, agricultural inputs may well be comparable to or larger than cesspool inputs at the watershed level, although a detailed analysis would be required to determine the true magnitude of agricultural inputs and the spatial distribution of inputs relative to monitoring wells in the study region.

A potential role for natural inputs is suggested by the predominance of forested land mauka of MW-1 and MW-2, and by the local topographic low immediately east of MW-1. As previously noted, the topographic low accumulates substantial amounts of local runoff and is likely to be a significant source of local recharge. The area of the low is mostly grass, surrounded by forest, and is used for grazing cattle and goats. Natural soils can leach significant quantities of nitrogen, particularly if the organic content is high, and information on soils in the area suggests that depositional sites like this one may accumulate significant amounts of organic matter (Lum and Stearns 1970). Thus it seems possible that some of the elevated nitrogen observed in MW-1 may be derived from this source. However, given the relatively low nitrogen levels observed in MW-2, and the probability that these levels represent natural soil leaching, it seems unlikely that even elevated leaching from highly organic soils in the topographic low could produce groundwater nitrogen levels as high as those observed in MW-1. Thus, it seems likely that the elevated levels observed in MW-1 are due at least partially to another source.

Phosphorus

Phosphorus is a potentially important nutrient in aquatic systems, particularly in tropical coastal waters, where ecosystem productivity frequently is phosphorus-limited (Howarth et al. 1995). Phosphorus in sampled groundwater occurred primarily as dissolved organic phosphorus (DOP), with lesser contributions from phosphate (Figure 11). Pre-storm total phosphorus levels varied between wells in a manner similar to that observed for total nitrogen, with the lowest levels in MW-2, and higher levels in MW-1, -3, and -4. Total phosphorus levels rose sharply in wells MW-1 and MW-3 following the 11/13-17 storm, primarily due to increases in DOP, but returned rapidly to levels similar to pre-storm conditions. In contrast to total nitrogen levels, post-storm total phosphorus levels in MW-1, -3, and -4 were relatively similar, varying by only about a factor of two.

Unlike nitrogen, phosphorus generally is not transported effectively by groundwater. Microbial oxidation of organic material (including DOP) ultimately results in the production of phosphate, which has a strong affinity for particle surfaces, particularly particles containing iron oxy-hydroxides and/or carbonates. Iron oxy-hydroxides are common in the highly weathered clays found in many Hawaiian soils, and carbonates dominate soils in the study area, so low dissolved phosphorus levels should be expected in Waimanalo groundwater. Evidence for removal of phosphorus from the dissolved phase is provided by the generally high N/P ratios

observed in all wells. Decomposition of organic matter (natural or sewage) should release nitrogen and phosphorus in a molar N/P ratio somewhere between 4/1 and 8/1: observed N/P ratios are significantly higher, with ratios in mauka wells on the order of 10 to 20/1, and makai wells having ratios of about 50 to 300/1.

Total Organic Carbon

Total organic carbon (TOC) was measured to determine the degree to which organic carbon might contribute to denitrification in makai groundwater. At low oxygen levels, certain bacteria can use the oxygen contained in nitrate molecules as a substitute for dissolved oxygen in the oxidation of organic carbon. In the process, nitrate is converted to nitrogen gas (N_2), reducing nitrate loads in groundwater. Nitrate consumption occurs in a constant ratio relative to the amount of organic carbon consumed, with 2/3 of a mole of nitrate being consumed for each mole of carbon consumed. Thus it is possible to estimate the potential for denitrification by measuring organic carbon and calculating the amount of nitrate that would be consumed if all of the organic carbon were consumed by denitrifying bacteria.

TOC levels in all wells were generally similar, falling in the range of 100 - 400 μ M (1.2 - 4.8 mg/l) (Figure 11). We have not located any other measurements of TOC in groundwater, but these levels are generally similar to those found in Hawaiian streams (Matsuoka et al. 1991; Hoover and Mackenzie in prep.). As for nitrogen and phosphorus, TOC levels in all wells increased slightly following the storm of 11/13-17, but changes were generally minor throughout the study period. In principal, the observed TOC levels are sufficient to support some denitrification, but even if all of the available TOC was consumed via denitrification, nitrate levels in contaminated groundwater would not decrease significantly (Figure 11(a), (c), (d)). In addition, the similarity in TOC levels between wells, particularly between MW-2, where nitrogen levels are very low, and MW-3 and -4, where nitrogen levels are high, suggests that the observed TOC represents primarily refractory organic compounds that are relatively resistant to microbial oxidation. Thus, barring additional inputs of organic carbon to the groundwater, denitrification cannot provide a significant reduction in groundwater nitrate levels.

Silica

Silica is an important nutrient for some phytoplankton species, but silica is relatively unreactive in groundwater, making it a useful tracer for groundwater sources. In general, silica levels increase with time of exposure to silica-containing rocks and soils (e.g. basalt and associated weathering products) (Visher and Mink 1964; Tenorio et al. 1969). As a result, silica levels in storm runoff are generally low, and groundwater levels typically increase with age.

Silica measurements can be affected by storage artifacts. In particular, freezing frequently results in a significant loss of silica from the dissolved phase. To assess the degree to which freezing of nutrient samples might affect silica measurements, we measured silica levels in frozen nutrient samples and in refrigerated sample splits from 11/6, 11/21 and 11/24 (Figure 12). While silica levels in frozen samples were consistently lower than levels in refrigerated samples, differences were relatively minor. In addition, the reduction did not affect significantly the comparison of silica levels at different wells or the resolution of depth gradients in silica concentrations. Thus, analysis of refrigerated sample splits was discontinued and all of the results discussed here are based on analysis of frozen samples.

Silica levels in mauka wells were very similar at about 250 μM (15 mg SiO_2/l), much like values observed in storm runoff in Hawaiian streams (Matsuoka et al. 1991), while MW-3 levels were roughly 300 μM (18 mg SiO_2/l) and MW-4 levels were 400 to 500 μM (24 to 30 mg SiO_2/l) (Figure 11). Concentrations in all wells decreased noticeably following the storm of 11/13-17, consistent with dilution of existing groundwater by lower-silica stormwater. The relatively high concentrations observed in the makai wells likely reflect contributions by cesspool effluent. Water leaching from cesspools comes from the municipal water supply, which has a silica concentration of about 500 μM (Appendix 2). Combined with the observed high nitrogen levels, this suggests that water sampled in MW-4 is primarily cesspool effluent. Lower silica levels in MW-3 indicate significant dilution, consistent with the lower nitrogen levels observed in MW-3 as well. Because there do not appear to be any significant external sources of groundwater to this portion of the watershed (see Well Heads), dilution is probably primarily due to mixing with runoff water infiltrated from the adjacent topographic low, which should contain almost no silica.

Physical Parameters

Salinity measurements indicated that groundwater salinities were on the order of 1 to 2 ‰ throughout the study period, demonstrating that seawater was not mixing extensively with the sampled groundwaters. It should be noted that refractometers are generally suitable for accurate salinity determination only when salinities exceed 3 ‰, as shown by the difference between refractometer and precision salinometer values determined for the 11/6 samples (Table 3). Since sampled well waters were characterized by salinity levels below this value, refractometer results are imprecise, but do serve to confirm consistently low salinities in all wells. For future groundwater studies the WRRC laboratory recommends using a conductivity assay, as this type of assay is more sensitive than refractometer analysis at low salinity levels and less expensive than the precision salinometer method.

The pH levels in well water samples did not vary significantly, with values ranging from 7.60 to 8.13, and no clear differences between mauka and makai wells, between individual wells in the mauka and makai regions, or between pre- and post-storm samples in individual wells, indicating no major fluctuation in the chemical composition of the groundwater.

Turbidity values were consistently low, ranging from 0.6 to 24.0 NTU. Most measurements were less than 10 NTU, with the few higher values generally associated with samples that also exhibited high enterococci levels.

Microbiological Parameters

Results of sample analyses for fecal bacteria are summarized in Table 3. These data show that most of the well water samples obtained were negative for the four fecal indicator bacteria assayed, and that the water samples obtained from these monitoring wells were not consistently contaminated with fecal bacteria. However, elevated concentrations of fecal indicator bacteria were recovered during two of seven sampling days, both of which followed periods of significant rainfall in the area. The first of these positive sampling day was on 11/6/96 when elevated concentrations of fecal coliform, (144-148 CFU/1000 ml), *E. coli* (74-80 CFU/1000 ml), enterococci (1440-3040 CFU/1000 ml) and *C. perfringens* (0-3 CFU/1000 ml) were recovered from the makai wells (MW-3 and MW-4). On the same sampling day, lower but still significant concentrations of *E. coli* (0-2 CFU/1000 ml), enterococci (8-50 CFU/1000 ml) and *C. perfringens* (0-4 CFU/1000 ml) were recovered from the mauka wells (MW-1 and MW-2). The second positive sampling day was 11/21/96. On this date, enterococci was the only fecal indicator recovered, with a very high concentration (>5,000 CFU/1000 ml) found in MW-2, low concentrations in MW-1 (6 CFU/1000 ml) and MW-4 (4 CFU/1000 ml), and none in MW-3.

In addition to fecal bacteria, groundwater samples from both mauka and makai wells were analyzed for total bacteria, or bacterial populations not specifically related to sewage ("heterotrophic plate count", Table 3). In deep ground water obtained by BWS for drinking purposes, the total bacterial count is approximately 3×10^4 /1000 ml. Levels similar to this were observed in water samples from MW-3 and MW-4 on 11/21/96. For all other samples concentrations of total bacteria were much higher, ranging from 10 to 10,000 times the level found in deep groundwater samples. These results are consistent with the idea that elevated nutrient concentrations enable bacteria in these waters to maintain significantly larger populations than found in uncontaminated groundwater.

The variability in recovery of different indicator organisms at different wells and different times is somewhat counterintuitive, but some of the variability can be explained by examining the relative recoveries of specific organisms. The higher recovery of enterococci as compared to fecal coliform and *E. coli* reflects the generally greater ability of enterococci to survive in

adverse environments as compared to fecal coliform and *E. coli*. On one occasion (11/6/96) *E. coli* was recovered whereas fecal coliform was not. The most likely explanation for this is that the *E. coli* method includes a resuscitation step to better recover stressed bacteria as compared to the fecal coliform assay. These results support previous data that fecal coliform and *E. coli* are rapidly stressed when exposed to all environmental conditions including wastewater. *C. perfringens* is normally present in sewage at much lower concentrations than fecal coliform, *E. coli* or enterococci, and thus would not be expected to occur in significant concentrations if the other indicator organisms were not also present. However, *C. perfringens* is known to be the most stable of all fecal bacteria and its source is much more specific to sewage, so measurable levels may occur even when other indicators are low or undetectable.

Fecal bacterial levels in contaminated groundwater water may vary significantly depending on the source of the contamination and degree of dilution. For instance, sources that might conceivably deliver significant amounts of fecal bacteria to groundwater in the Waimanalo watershed include (1) residential cesspool effluent, (2) effluent from the Waimanalo Sewage Treatment Plant injection wells, (3) leaking above-groundwater branch sewage lines (interceptor lines in the study region are all well below the groundwater table, resulting in groundwater preferentially flowing into sewer lines rather than sewage leaking out of pipes at breaks), and (4) surface runoff waters (e.g. streams and local overland runoff), a proportion of which percolates through the soil to recharge shallow and deep groundwater aquifers. The general concentrations of fecal bacteria in these sources can be estimated based on previous studies conducted by the Water Resources Research Center (Table 4). Of these sources, concentrated sewage in primary and secondary effluent and in cesspool effluent all exhibit significant levels of fecal bacteria, while storm drains and stream waters can be expected to have significantly lower levels, primarily due to dispersed sources and dilution. Thus, the presence of significant fecal bacteria in groundwaters seems likely to reflect some sort of effluent input. In the study area, an injection well source seems unlikely, as wells are roughly 200 feet deep and have solid casings down to 70 - 100 feet, forcing injected effluent into a deep, highly permeable carbonate formation that appears to be hydraulically isolated from the surface sand aquifer monitored in this study. Leakage from branch sewage lines is possible in the sewerred mauka region, but would require fecal bacteria to be transported a significant distance to be detected in makai wells. Thus, local cesspools seem likely to be the source of bacteria sampled in the makai region, with the single very high level observed in MW-2 possibly due either to a local sewage leak or cesspool input.

Given the abundance of cesspools in the region sampled by the makai wells, the generally low levels of bacterial contamination in sampled waters are somewhat surprising. If the wells are sampling effluent from nearby cesspools, then these data suggest that the cesspools near the monitoring wells are effective at retaining bacteria, unlike cesspools in many regions that have

been shown to be significant sources of both nutrients and bacteria to groundwaters. In addition, there are significantly more cesspools in the makai region than in the mauka region, thus we would have expected more frequent detection of fecal bacterial contamination in well water samples from the makai wells than in the mauka wells. Instead, on the two occasions when indicator bacteria were recovered, they were found in both areas, and at significantly different levels that did not vary consistently with the relative abundance of cesspools. Thus the source of groundwater bacteria and the potential for transport to coastal waters remains unclear. While the scarcity of detections makes it difficult to speculate on the mechanisms responsible, two options that should be considered are transient effects associated with groundwater dynamics, and the possibility that MW-3 and MW-4 are sampling anomalous portions of the makai aquifer.

If beach lot cesspools are generally effective at retaining bacteria, then the distribution of bacteria in the soils around a cesspool should decline rapidly with distance from the cesspool. However, the rate of decline should vary with the rate at which effluent flows outward from the cesspool. Under conditions where there is no net groundwater flow past the cesspool, the distribution of bacteria around the well should form a roughly circular "halo", while a steady flow past the cesspool would stretch the halo downstream and compress the upstream portion. Under varying groundwater flow conditions, such as those produced by intermittent storms, it seems likely that the shape of the halo would vary over time with the strength and direction of the storm-induced flow, leading to the possibility that groundwater in a monitoring well might contain bacteria only during high flow conditions, or only during low flow conditions, depending on whether the well was located downstream or upstream from the nearest cesspool. In addition, a sudden increase in flow might produce a transient downstream pulse of bacteria if the increase were sufficient to temporarily rupture the organic "mat" that typically acts to filter effluent leaving a cesspool. Both of the dates when bacteria were detected followed significant rain events in the study area (Figure 2), thus it seems possible that storm-induced variation in bacterial "halos" or transient bacterial breakthrough might be responsible.

The second possibility is that the makai monitoring wells are not sampling groundwater typical of average conditions in the aquifer. This might occur if the wells were not located in the direct flow of cesspool effluent so that the water in the monitoring wells represented an unusually uncontaminated region in the aquifer, or if the cesspool(s) upstream from the monitoring wells were operating significantly more efficiently than the average for the region. In the former case, even if cesspools were leaching fecal bacteria to surrounding groundwater, water samples from the monitoring wells would not detect the contamination. This possibility seems unlikely at at least one of the makai wells (MW-4), where nitrogen and silica levels were both comparable to those expected in undiluted effluent. The other makai well had surprisingly low nitrogen levels and reduced silica levels, suggesting significant dilution, but the source of the

dilution remains unclear. The stability of the makai heads throughout the study period suggests that the sampled aquifer does not receive significant inputs of groundwater from neighboring areas, so the most likely source of dilution appears to be spatially uneven infiltration of locally-precipitated stormwater, as discussed in Well Heads. However our inability to precisely determine the direction of flow in the region makes it impossible to resolve the question at this point. The second possibility may be more likely: even in sandy soils cesspools will eventually clog, and failure rates (i.e. clogging requiring cesspool pumping) in the beach lot region have been noted to be quite high (Wilson Okamoto & Associates, Inc. 1984). Thus it is possible that the potential for bacterial contamination varies significantly from one cesspool to another, and that the regions monitored by the makai wells actually represent anomalously uncontaminated portions of the aquifer.

In summary, most of the data analyzing water from the monitoring wells did not indicate that cesspools were contaminating the groundwater. However, the apparent barrier to groundwater flow from the mauka to makai regions makes it impossible to obtain definitive conclusions regarding the direction of groundwater flow in the study area, and thus to determine whether the water sampled in the makai wells was representative of the average quality of the groundwater in the study area. Specifically we have been unable to resolve the fundamental questions of how well the cesspools in the study area are operating, and whether these cesspools are contaminating groundwater with sewage-borne pathogens to a degree that might lead to significant inputs to coastal waters. However, the study has provided the foundation for a more quantitative determination of nutrient loading and delivery if additional wells are installed, and has collected valuable baseline data for future work.

CONCLUSIONS and RECOMMENDATIONS

Groundwater analyses have demonstrated that cesspools in the Waimanalo beach lot region are contributing significant amounts of nitrogen to groundwaters. Because organic carbon levels in sampled waters are relatively low, denitrification is unlikely to reduce groundwater nitrate levels significantly, and the bulk of the nitrogen measured in groundwater is likely to reach coastal waters. Phosphorus levels in groundwaters are also quite low, probably due to oxidation of organic forms to phosphate and adsorption of phosphate to soil particles. As a result, nitrogen and phosphorus delivery to coastal waters probably occurs with a very high N to P ratio, significantly in excess of the uptake ratios exhibited by marine phytoplankton and macrophytes. If cesspool loads dominate inputs of nitrogen and phosphorus to adjacent coastal water, this suggests that significant nitrogen should remain in coastal waters after biotic uptake, or that biotic uptake should be phosphorus-limited. Recent studies in Kaneohe and Mamala Bays have shown that nutrient uptake by phytoplankton appeared to be nitrogen-limited (Laws and Atkinson 1994; Laws and Ziemann 1995). Thus cesspool nutrient inputs to Waimanalo Bay may potentially affect the Bay ecosystem by favoring organisms adapted to phosphorus limitation. However, determination of the effects of cesspool nutrient loads on biological processes in Waimanalo Bay will require a more precise determination of the magnitude and pathways of cesspool nutrient fluxes to the Bay, as well as an accounting of other nutrient sources in the watershed.

Levels of fecal indicator bacteria in sampled groundwater were generally low to undetectable, suggesting that the sandy soils in the study area may be relatively efficient at retaining bacteria. Thus, the potential for microbial transport to coastal waters appears to be low. However, hydrologic data obtained in this study revealed that groundwater flow in the study region is unexpectedly complex, so the true potential for microbial contamination cannot be adequately resolved without additional data.

To better address the potential for both nutrient and microbial contamination of coastal waters, we recommend that the following tasks be performed:

1. More wells should be installed at locations strategically related to the mauka and makai monitoring wells used in this study. Samples from existing and additional wells should be monitored for the parameters analyzed in this study. The data obtained from additional wells would greatly increase our ability to predict groundwater movement and the impact of cesspools on groundwater quality.
2. Dye or other tracer transport tests should be performed using cesspools adjacent to the monitoring mauka and makai wells during both dry- and wet-weather conditions. One promising technology currently being developed by one of us (A.I.E.) uses helium as a tracer. This

approach is generally less expensive and has negligible impacts on groundwater quality when compared to traditional dye tests. Well-water monitoring would then provide simple verification of the ability of adjacent cesspools to affect groundwater sampled by monitoring wells. Wells should simultaneously be monitored for fecal bacteria and for fecal bacterial viruses which are structurally similar to human enteric viruses. These results would provide definitive data to predict the movement of water and other constituents from cesspools to nearby groundwater.

3. Monitoring of well water samples should include assays for viruses. It should be noted that fecal bacteria are used only as indicators of sewage-borne microbial pathogens. However, the movement and survival of fecal bacteria within the soil profile can differ substantially from that of sewage-borne pathogens such as human enteric viruses, which are much smaller and which survive much longer. As a result, the absence of fecal bacteria in groundwater cannot be relied on to ensure that the groundwater is not contaminated with sewage-borne human enteric viruses (Sobsey, 1983). Thus, additional studies should be conducted to determine whether the well water samples contain fecal-borne viruses. In this regard, assays for viruses of fecal bacteria are relatively simple and should be done first before a decision is made to assay for human enteric viruses, which is a very involved and expensive procedure.

4. Detailed three-dimensional (3-D) or "pseudo" 3-D modeling should be used to simulate groundwater dynamics, allowing prediction of cesspool fluxes of nutrients to groundwater and of groundwater fluxes of nutrients to Waimanalo Bay. Successful modeling of the flow field in the area is essential to estimating accurately cesspool loading to the ocean. One pseudo 3-D model that might be used is SHARP, which treats the boundary between the fresh and salt water as a sharp interface but allows consideration of both vertical and horizontal variability in model parameters. Although not as computationally efficient, a fully three-dimensional model could also be developed to account for mixing at the freshwater/saltwater interface.

5. An additional modeling effort that should be considered is to address specifically the transport and fate of bacteria and viruses in the near-shore subsurface environment. This is a challenging task that to the best of our knowledge has not been addressed previously. Such a study has both practical and basic research value.

6. Quantification of cesspool nutrient loads to coastal waters will not be adequate to determine the importance of those nutrients to the coastal ecosystem. At a minimum, the major nutrient sources in the entire Waimanalo watershed need to be defined and the temporal and spatial variability in nutrient fluxes from these sources need to be estimated. It seems likely that sources associated with natural groundwater and runoff fluxes can be estimated roughly from available data, but that an assessment of fertilizer sources will require a specific inventory of agricultural activities and fertilizer use practices in the watershed.

REFERENCES

- American Public Health Association, American Water Works Association, Water Pollution Control Federation. (1995). Standards methods for the examination of water and wastewater, 19th edition. American Public Health Association.
- Department of Health (1996). Hawaii Administrative Rules Title 11, Chapter 62. Wastewater Systems.
- Fukunaga & Associates, Inc. (1985). As-built Plan: Makapuu Interceptor Sewer, Section 1. Division of Wastewater Management, Department of Public Works, City & County of Honolulu.
- Hagedorn, C. (1984). Microbiological aspects of groundwater pollution due to septic tanks. Groundwater Pollution Microbiology. John Wiley and Sons. Chapter 8.
- Harding Lawson Associates (1992). Installation Restoration Program Stage 1 Technical Report for Bellows Air Force Station, Hawaii. AFCEE ESO.
- Hoover, D. J. and F. T. Mackenzie (in prep). "Nutrient status of Hawaiian streams"
- Hoover, D. J., F. T. Mackenzie, J. Galloway et al. (in prep.). "The industrial ecology of nitrogen in Hawaii: 1945 - 1992."
- Howarth, R. W., H. S. Jensen, R. Marino and H. Postma (1995). Transport to and processing of P in near-shore and oceanic waters. Phosphorus in the Global Environment. Chichester, John Wiley & Sons. 323-356.
- Laws, E. A. and M. Atkinson (1994). A study of nutrient inputs, nutrient limitation, and their implications for fish production in Kaneohe Bay. University of Hawaii Research Report
- Laws, E. A. and D. Ziemann (1995). Ecosystem response study: Effects of sewage discharges and stream runoff on phytoplankton communities and water quality in Mamala Bay. University of Hawaii Research Report.
- Lum, D. and H. T. Stearns (1970). "Pleistocene stratigraphy and eustatic history based on cores at Waimanalo, Oahu, Hawaii." Geological Society of America Bulletin 81: 1-16.
- Matsuoka, I., V. E. Kunishige and M. G. Lum (1991). Water resources data: Hawaii and other pacific areas, Water Year 1991. USGS.
- MGD Technologies, Inc. (1996). Waimanalo Facility Plan Services for Monitoring Groundwater Wells. Letter to Hawaii Pacific Engineers, Inc., dated 11/5/96.
- Pacific Geotechnical Engineers, Inc. (1996). Waimanalo Facilities Plan & EIS Monitoring Well Logs. Report to Hawaii Pacific Engineers, Inc.
- Rail, C. (1989). Groundwater Contamination: Sources, Control and Preventive Measures. Technomic Publishing Co.
- Sobsey, M. (1983). Virology considerations in soil absorption of wastewater: Review of the literature and research needs. In, Proceedings from a Workshop on Research Needs Relating to Soil Absorption of Wastewater. National Science Foundation.

Swain, L. A. and C. J. Huxel (1971). Relation of drainage problems to high ground-water levels, Coconut Grove area, Oahu, Hawaii. USGS Water Resources Division Open File Report.

Takasaki, K.J., G.T. Hirashima and E.R. Lubke (1969). Water resources of Windward Oahu, Hawaii. U.S. Geological Survey Water-Supply Paper 1894.

Tenorio, P. A., R. H. F. Young and H. C. Whitehead (1969). Identification of return irrigation water in the subsurface: Water quality. Water Resources Research Center Technical Report No. 33.

Vacher, H. L. (1971). Late Pleistocene Sea-Level History: Bermuda Evidence. Ph.D. Dissertation, Northwestern University.

Visher, F. N. and J. F. Mink (1964). Ground-water resources in southern Oahu, Hawaii. U.S. Geological Survey Water-Supply Paper 1778.

Wilson Okamoto & Associates, Inc. (1984). Waimanalo Facility Plan. Division of Wastewater Management, Department of Public Works, City and County of Honolulu.

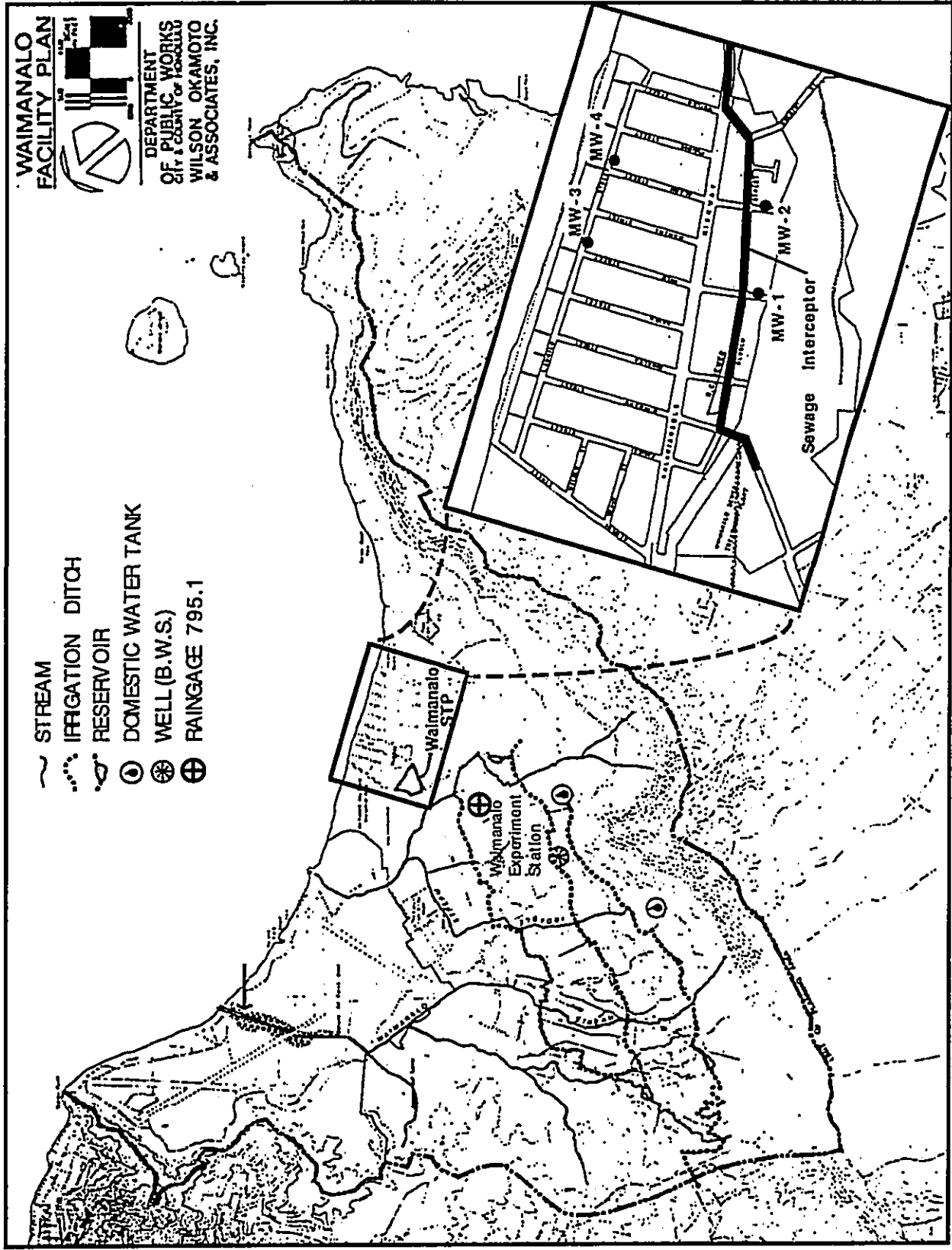

Figure 1. Waimanalo watershed and monitoring well locations in the "beach lot" region. Watershed map is modified from Wilson Okamoto and Associates, 1984. Kalaniana'ole Highway divides the unsewered makai region (100% cesspools) from the ~70% sewerd mauka region.

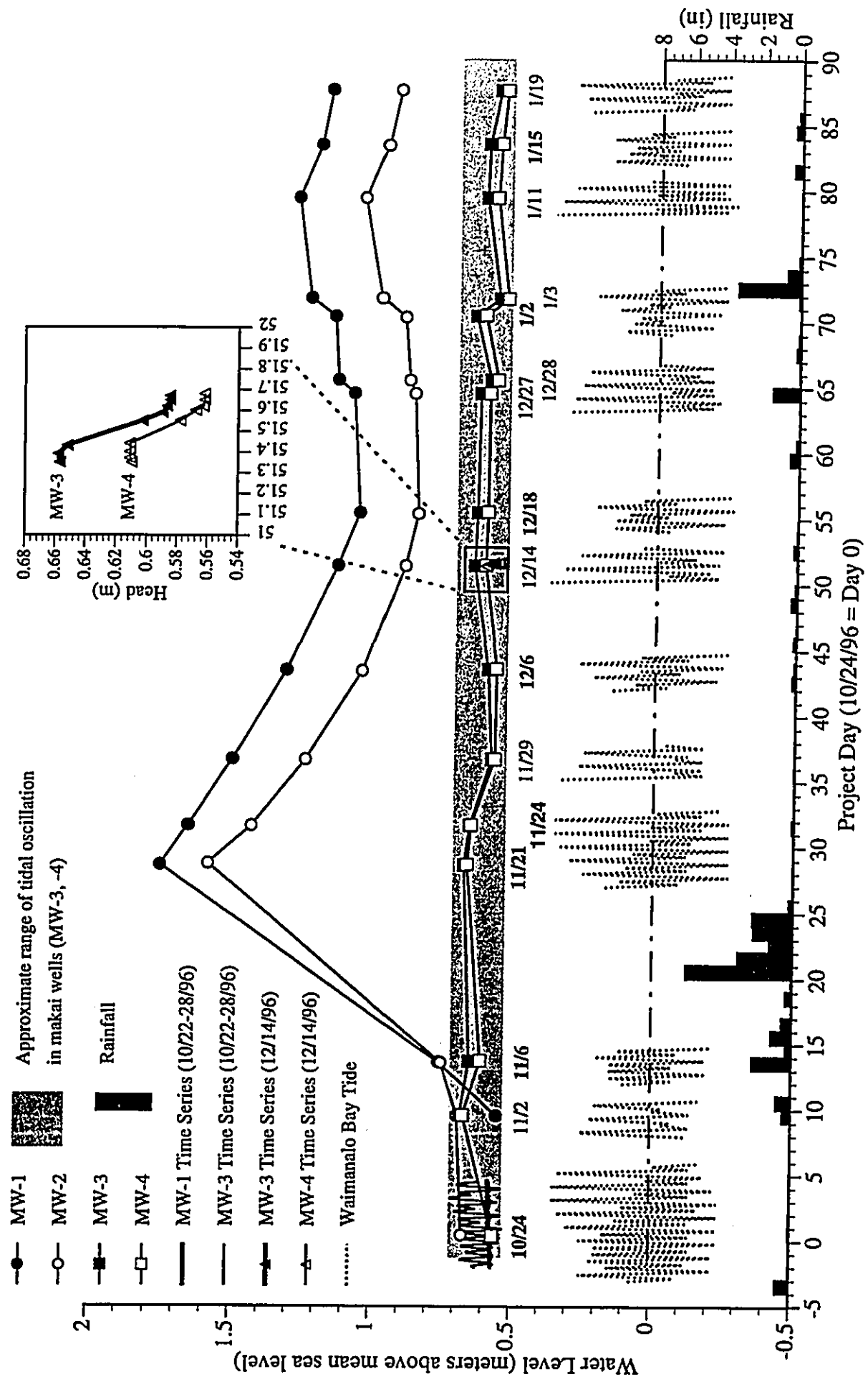

Figure 2. Waimanalo well heads, 10/22/96 through 1/19/97. With the exception of the time series data (10/22-28), heads prior to 11/6 may be unreliable due to variable measuring methods and instrument performance. Mauka heads (MW-1, -2) responded dramatically to the heavy rains of 11/13-17 (Project Day 20-24) and moderately to other precipitation events during the study period. In contrast, makai heads (MW-3, -4) stayed within a narrow range, suggesting that variability observed in these heads was due primarily to tidal effects. Waimanalo Bay tides are from standard tide tables with amplitude and phase corrections for Waimanalo Bay. Rainfall data are from DLNR daily records at the Waimanalo Experimental Station (Figure 1). Chemical/microbiological sampling dates are shown in bold.

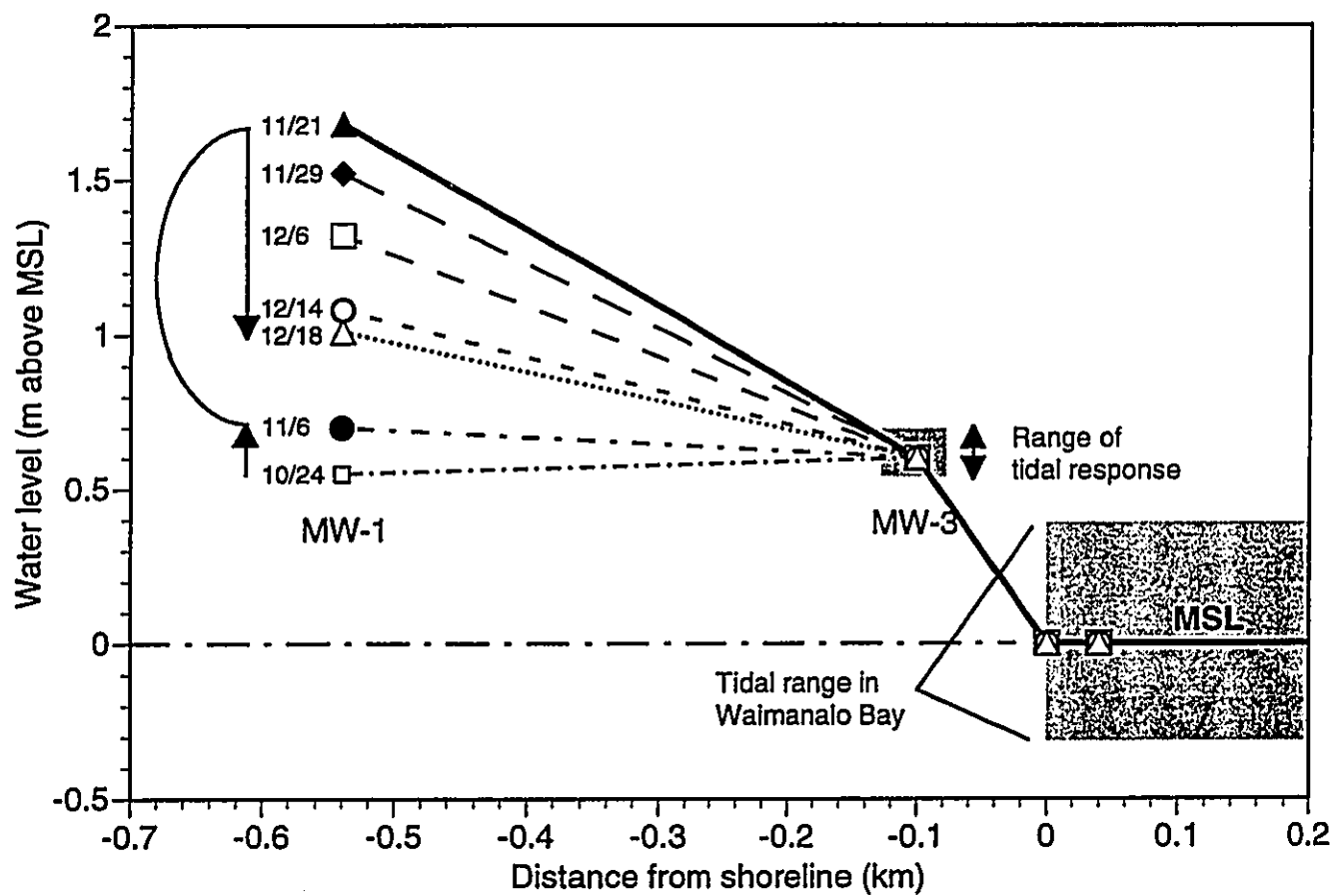

Figure 3. Groundwater heads across the MW-1/3 transect. The MW-1 head increased significantly following the 11/15-16 storm, then declined continuously through 12/18. After 12/18, the water level in MW-1 fluctuated in response to a series of moderate storms. MW-3 was not significantly affected by changes in water input to the watershed, staying within a relatively narrow range coincident with the range defined by the response to tidal forcing measured by MGD, Inc. Groundwater head gradients between MW-1 and MW-3 varied from -0.01% on 10/24 to +0.25% on 11/21. The gradient between MW-3 and the ocean (MSL) remained essentially constant at +0.6%. MW-2 and MW-4 heads responded very similarly to MW-1 and MW-3, respectively, with absolute post-storm heads slightly lower than shown above.

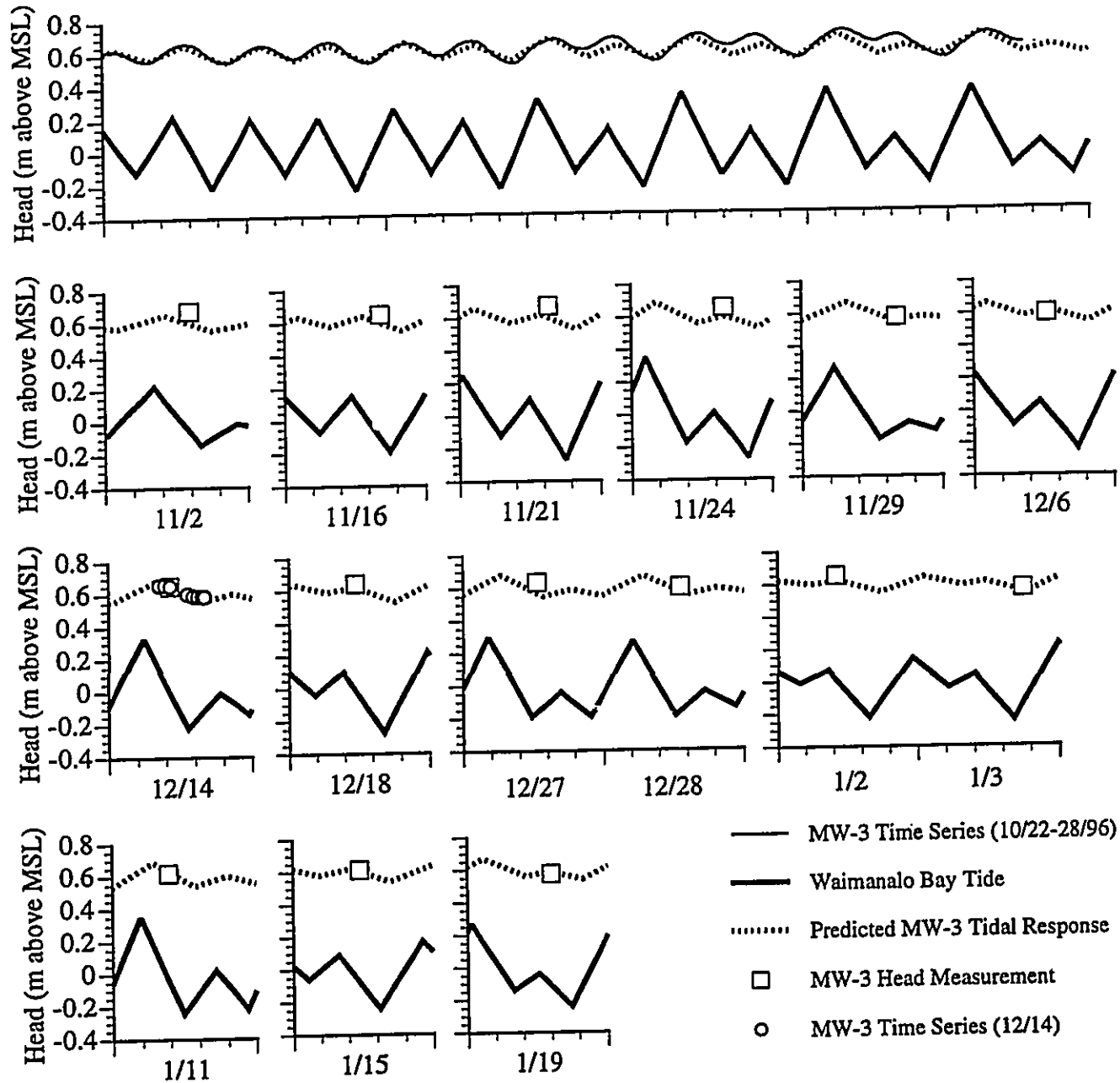

Figure 4. Tidal fluctuations in Waimanalo Bay, measured and predicted tidal response in MW-3, and individual MW-3 head measurements over the study period. The predicted response is based on the MGD continuous monitoring data (top panel), which showed a response of about 25% of the Bay amplitude and a 2 hour delay. Note that during periods of unequal tides in the MGD dataset that the MW-3 response is asymmetric, with the well response remaining higher than expected during the 12 -15 hour period following the higher of the high tides. Thus, head measurements higher than the predicted response during similar cycles later in the study period may be due to prediction error (e.g., 11/2, 11/21, 11/24 and 12/27). Even without this correction, measured heads never exceed predicted heads by more than about 10 cm. Because an increase on this order would have been expected from direct infiltration of local rainfall from the 11/13-17 storm alone, there appears to be little evidence that the makai region receives groundwater from adjacent areas.

- ▽— 11/6 3:40 descending ▽ 11/21 2:15 descending
-△..... 11/6 3:40 ascending △ 11/21 2:15 ascending
- ▽— 11/6 4:15 descending ▽ 11/21 3:05 descending
- ▲— 11/6 4:15 ascending ▲ 11/21 3:05 ascending

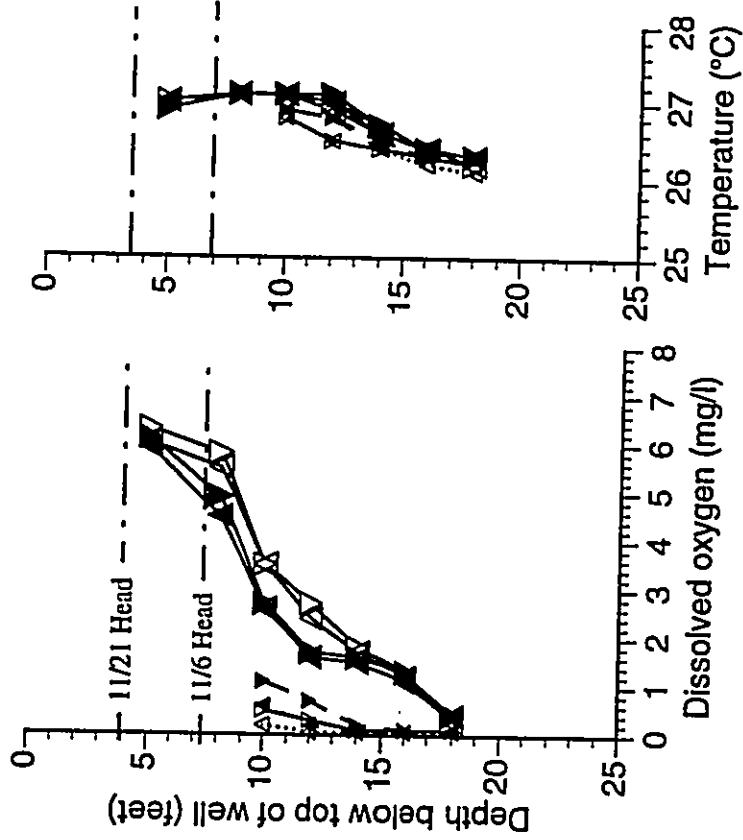
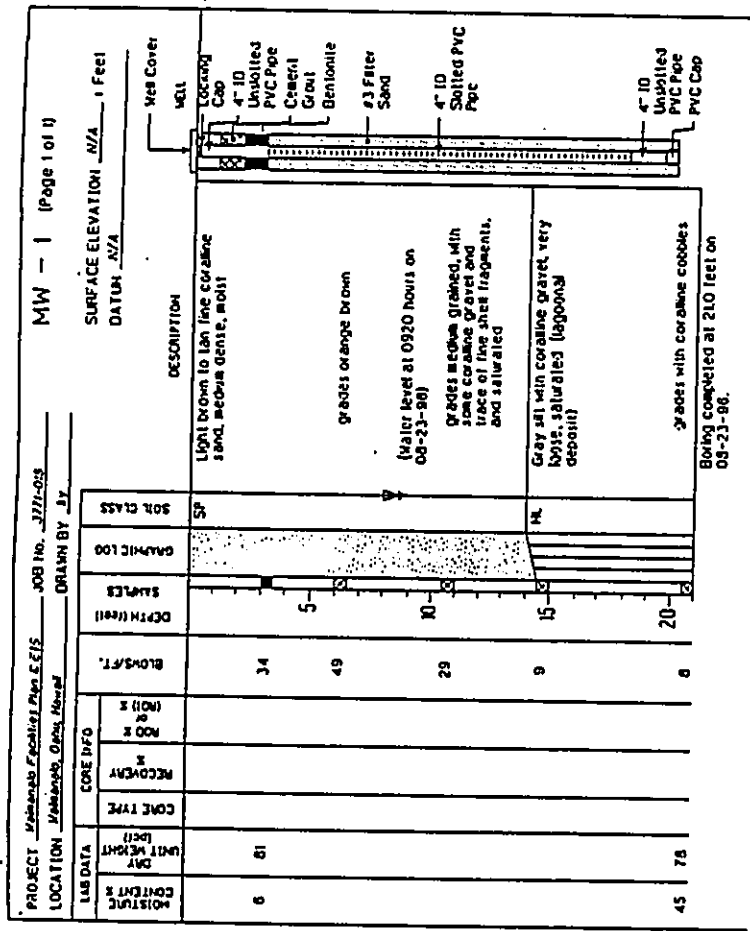

Figure 5(a). Pre- and post storm temperature and dissolved oxygen profiles in MW-1. The second set of profiles on each date represent post-sampling conditions. Well logs (Pacific Geotechnical Engineers, Inc.) are also shown for comparison.

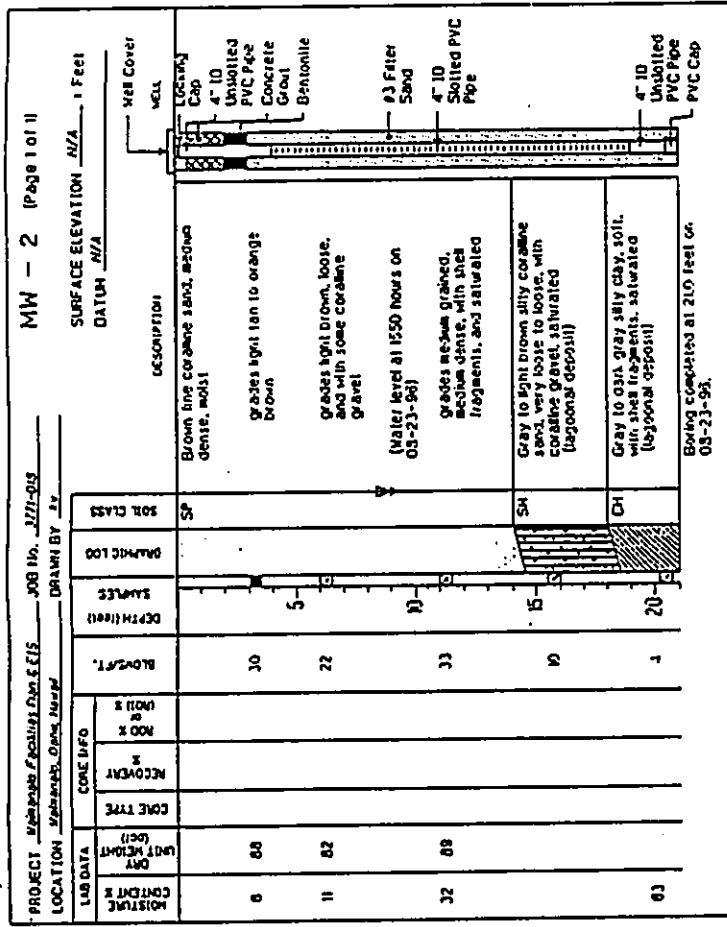
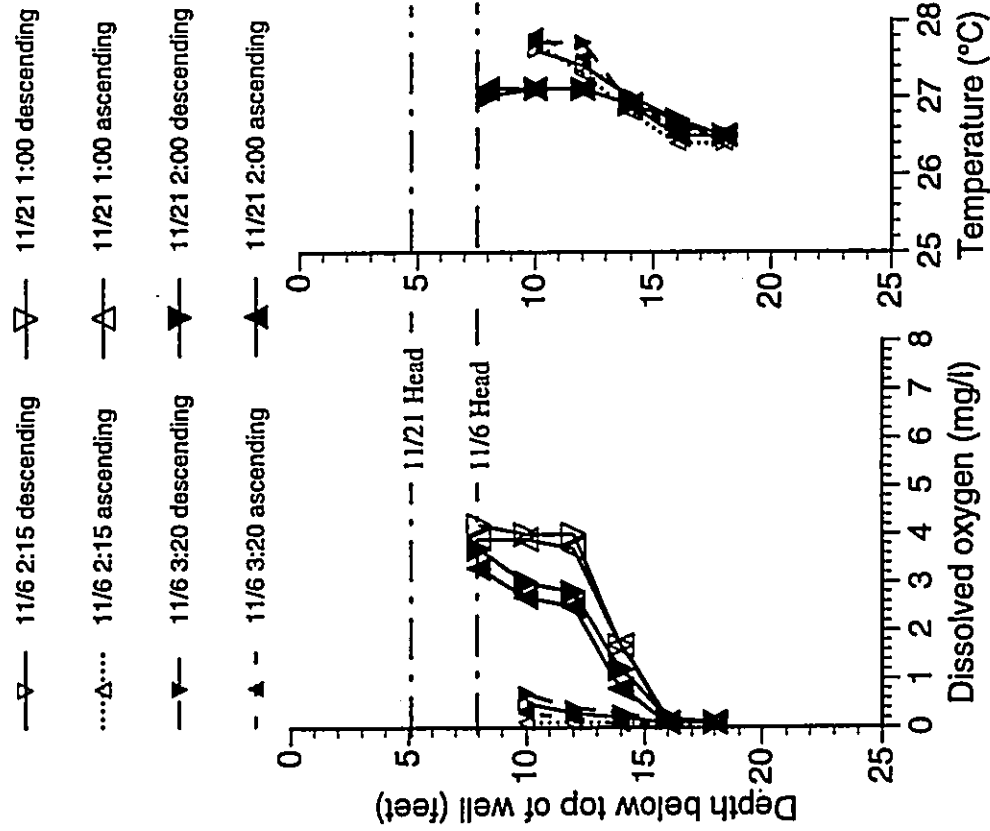

Figure 5(b). Pre- and post-storm temperature and dissolved oxygen profiles in MW-2.

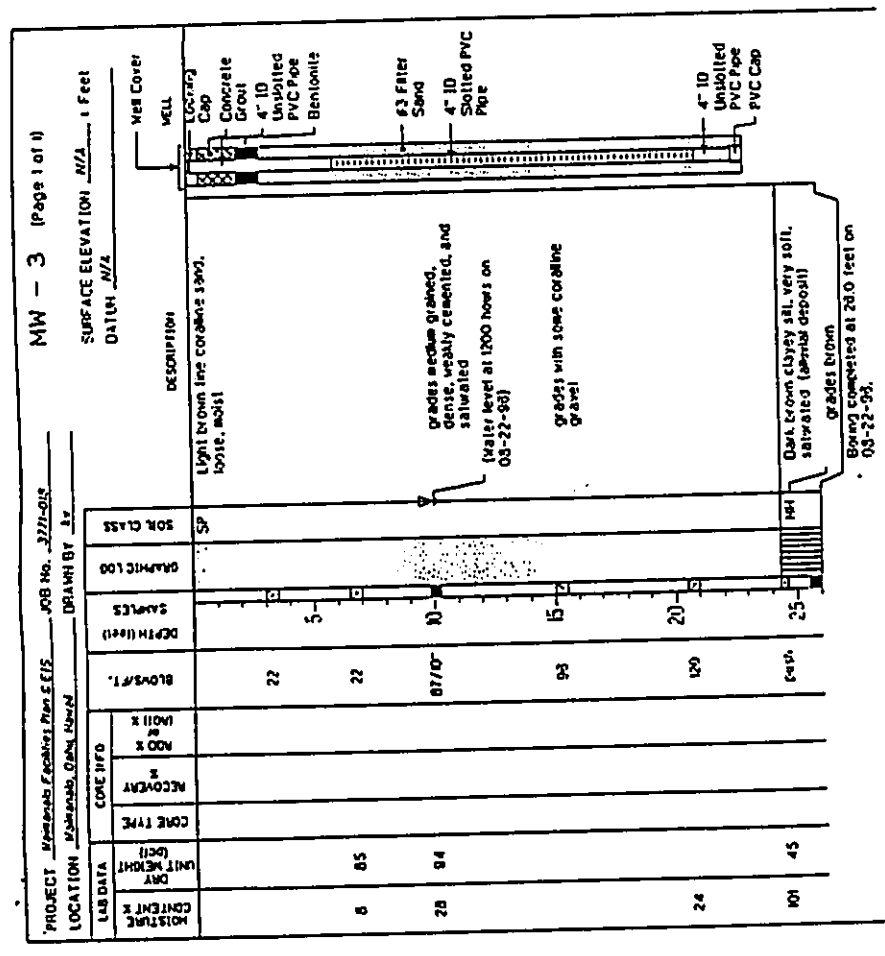
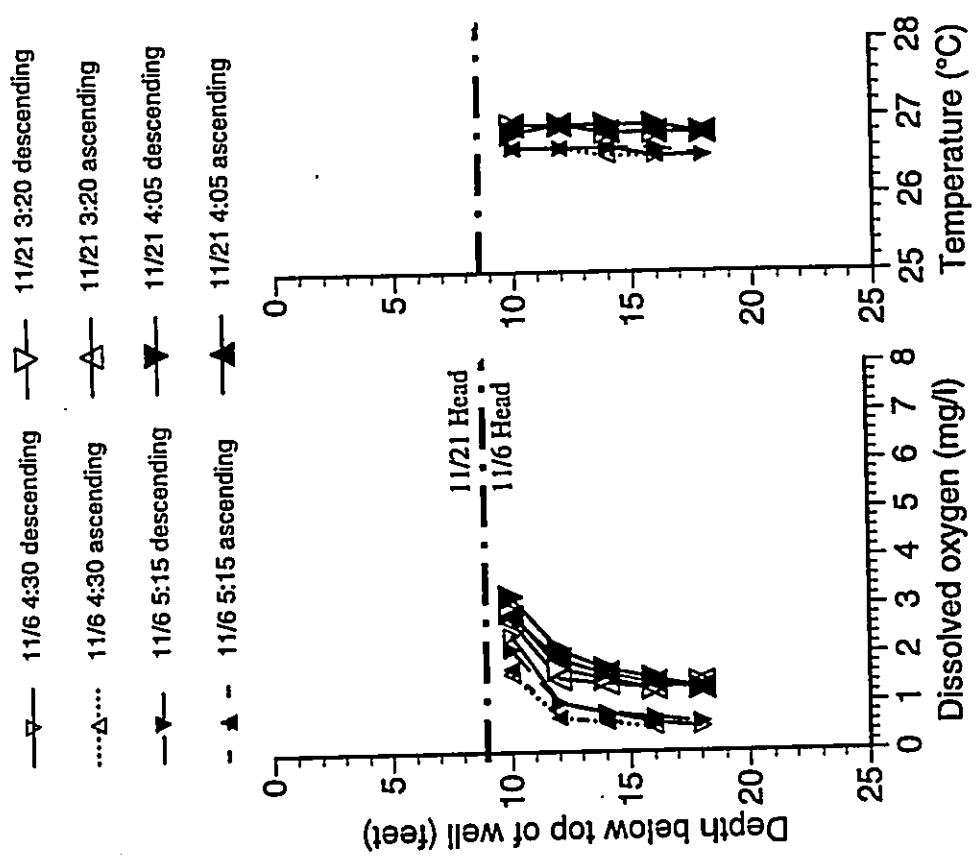

Figure 5(c). Pre- and post-storm temperature and dissolved oxygen profiles in MW-3.

- ▽— 11/6 5:30 descending
- △— 11/21 4:15 descending
-△..... 11/6 5:30 ascending
- △— 11/21 4:15 ascending
- ▽— 11/6 5:50 descending
- ▽— 11/21 4:50 descending
- ▲— 11/6 5:50 ascending
- ▲— 11/21 4:50 ascending

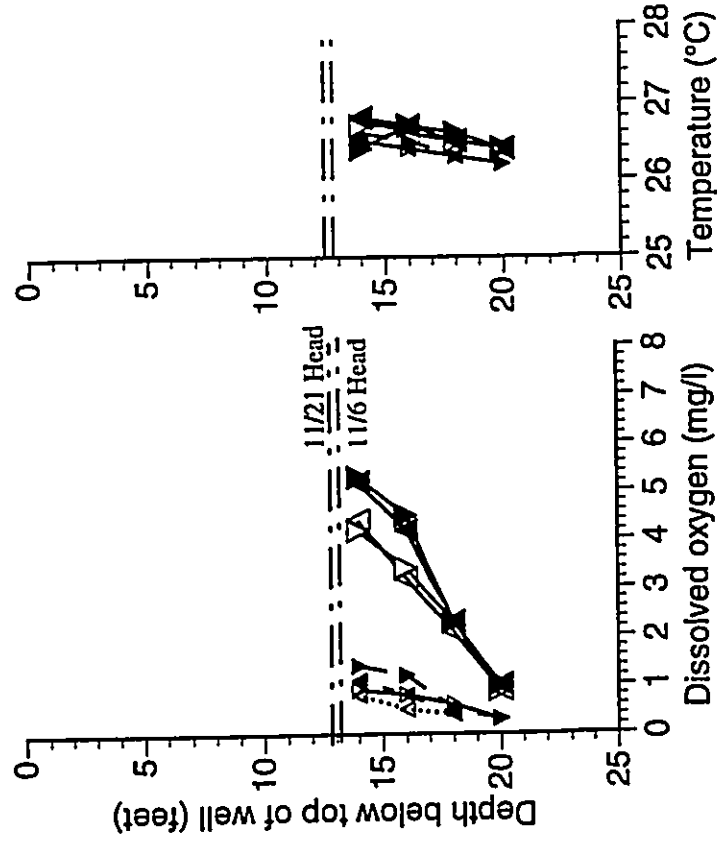
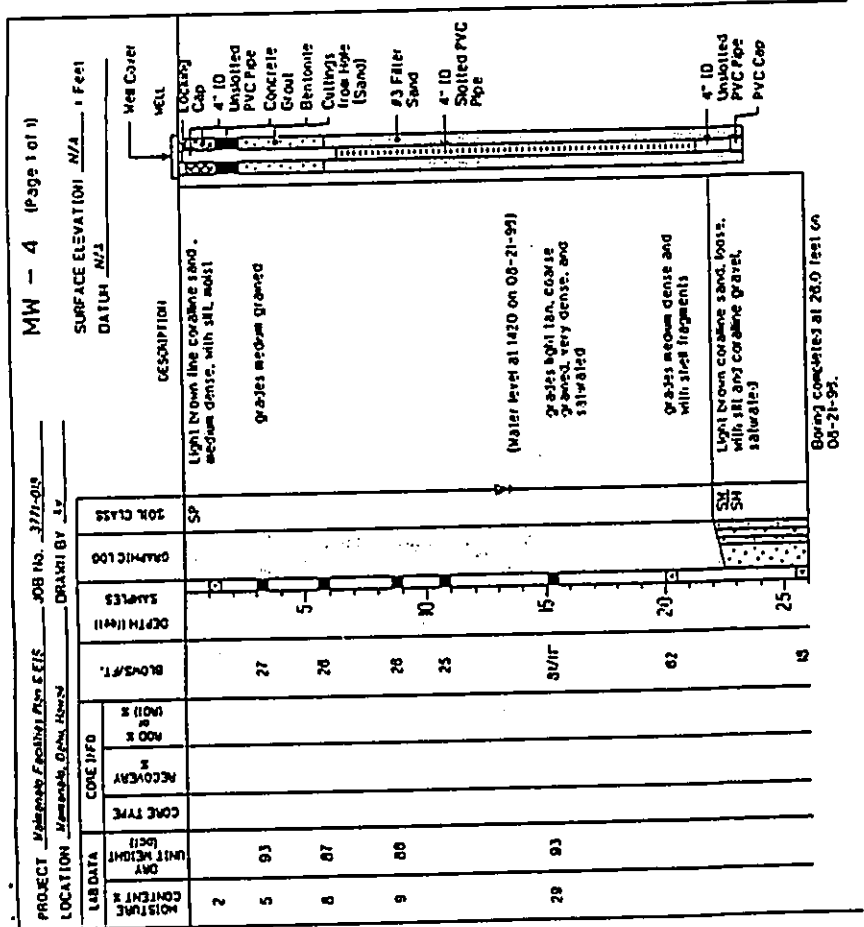

Figure 5(d). Pre- and post-storm temperature and dissolved oxygen profiles in MW-4.

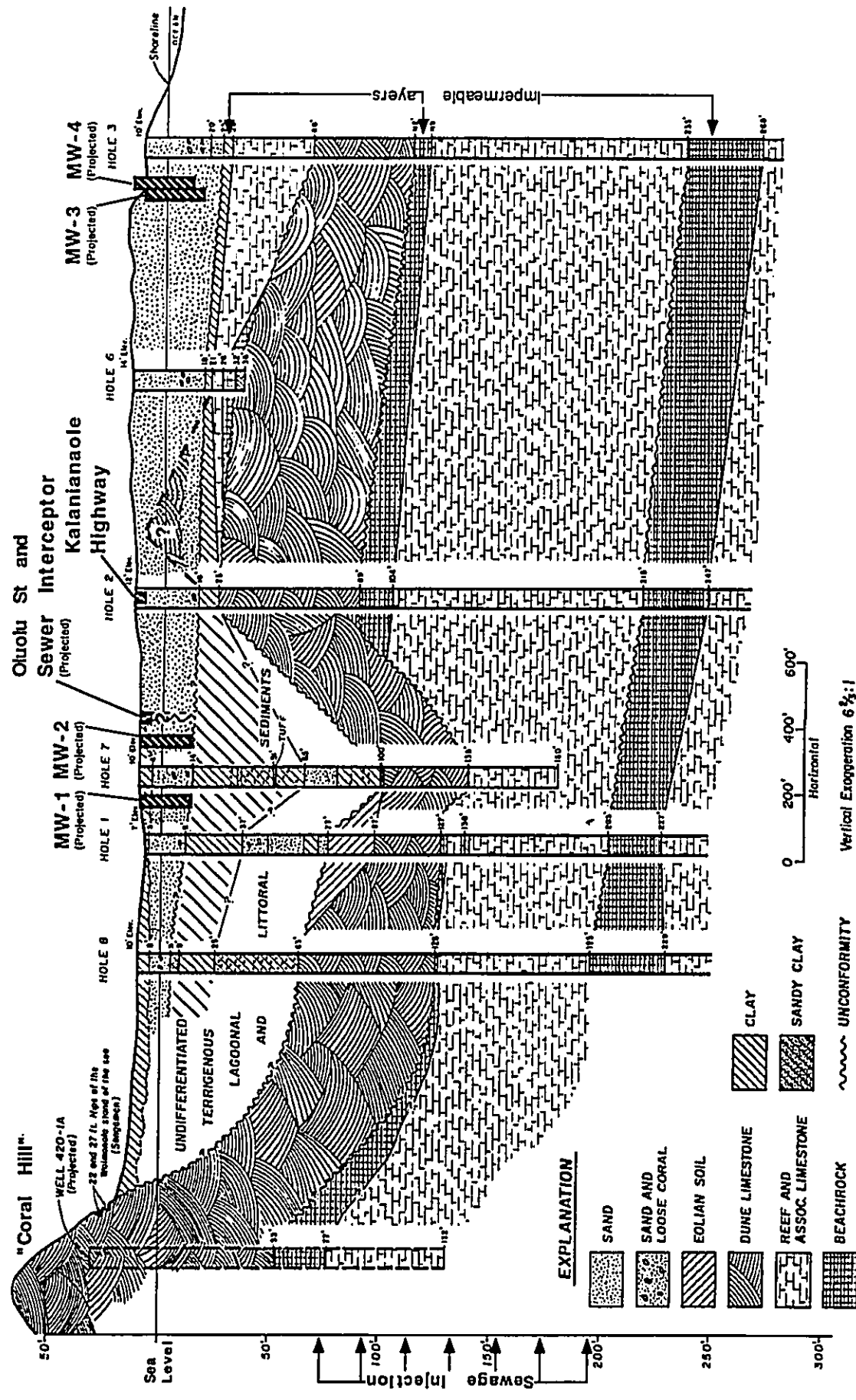

Figure 6. Geologic section through study area (Section A-A, Figure 7) (modified from Lum and Stearns 1970). Outcrop of ancient dune ("Coral Hill") is the surface expression of a buried dune formation whose contours suggest a second dune ridge peaking in the area between the mauka and makai wells (MW-1/2 and MW-3/4).

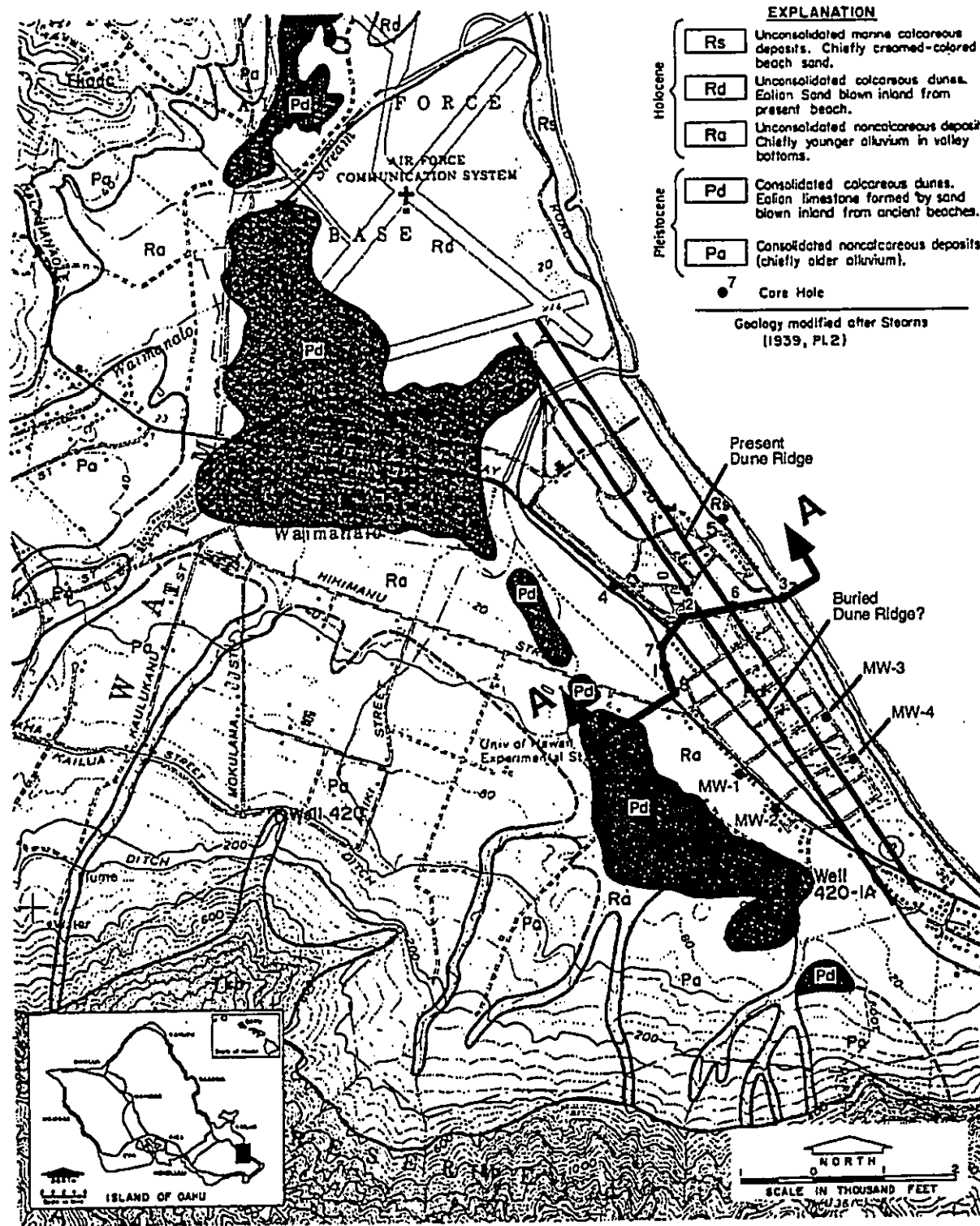

Figure 7. Geologic map of the study area (modified from Lum and Stearns 1970). Shaded areas are outcrops of an ancient dune ridge system that formed parallel to the present coastline. Present-day dunes are found closer to shore, while core data (Figure 6) suggest that a buried dune ridge may be present between the mauka and makai wells.

- 1 10/19 - na
- 2 10/24-A - na
- 3 10/24-B - na
- 4 11/2-A
- 5 11/2-B
- 6 11/6-A
- 7 11/6-B
- 8 11/21-A
- 9 11/21-B
- A 11/21-C - na
- B 11/24-A
- C 11/24-B
- D 11/29/96
- E 12/6-A
- F 12/6-B
- G 12/14/96
- H 12/18-A
- I 12/18-B
- J 12/28/96
- K 1/2-A
- L 1/2-B
- M 1/11/97
- N 11/15-A
- O 11/15-B

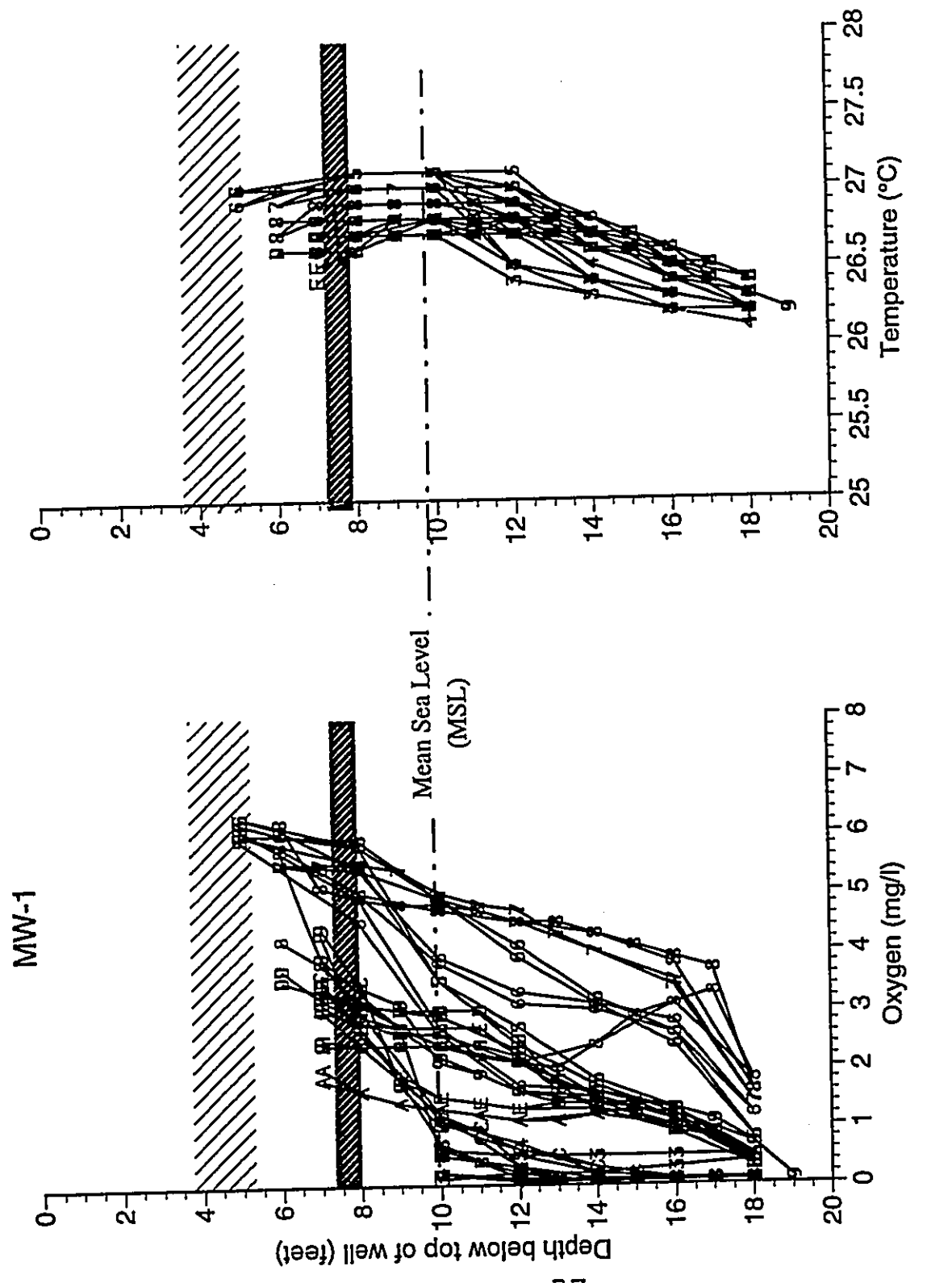

Figure 8(a). MW-1 temperature and dissolved oxygen profiles. Pre- and post-storm water levels are shown by dark and light hatched regions, respectively. Note that on dates where water samples were collected, post-collection profiles (e.g. 12/6-B) often exhibit lower oxygen levels than pre-collection profiles. This is likely due to diffusive uptake of oxygen from air overlying the well water column, with uptake depending on the gradient between well water and air and on the residence time of groundwater in the well.

- 1- 10/19/96
- 2- 10/24-A
- 2- 10/24-B
- 3- 11/2-A
- 3- 11/2-B - na
- 4- 11/6-A
- 4- 11/6-B
- 5- 11/21-A
- 5- 11/21-B
- 5- 11/21-C
- 6- 11/24-A
- 6- 11/24-B - na
- 7- 11/29/96
- 8- 12/6-A
- 8- 12/6-B
- 9- 12/14/96
- 11- 12/18-A
- 11- 12/18-B
- 12- 12/28/96
- 13- 1/2-A
- 13- 1/2-B
- 14- 1/11/97
- 15- 1/15-A
- 15- 1/15-B

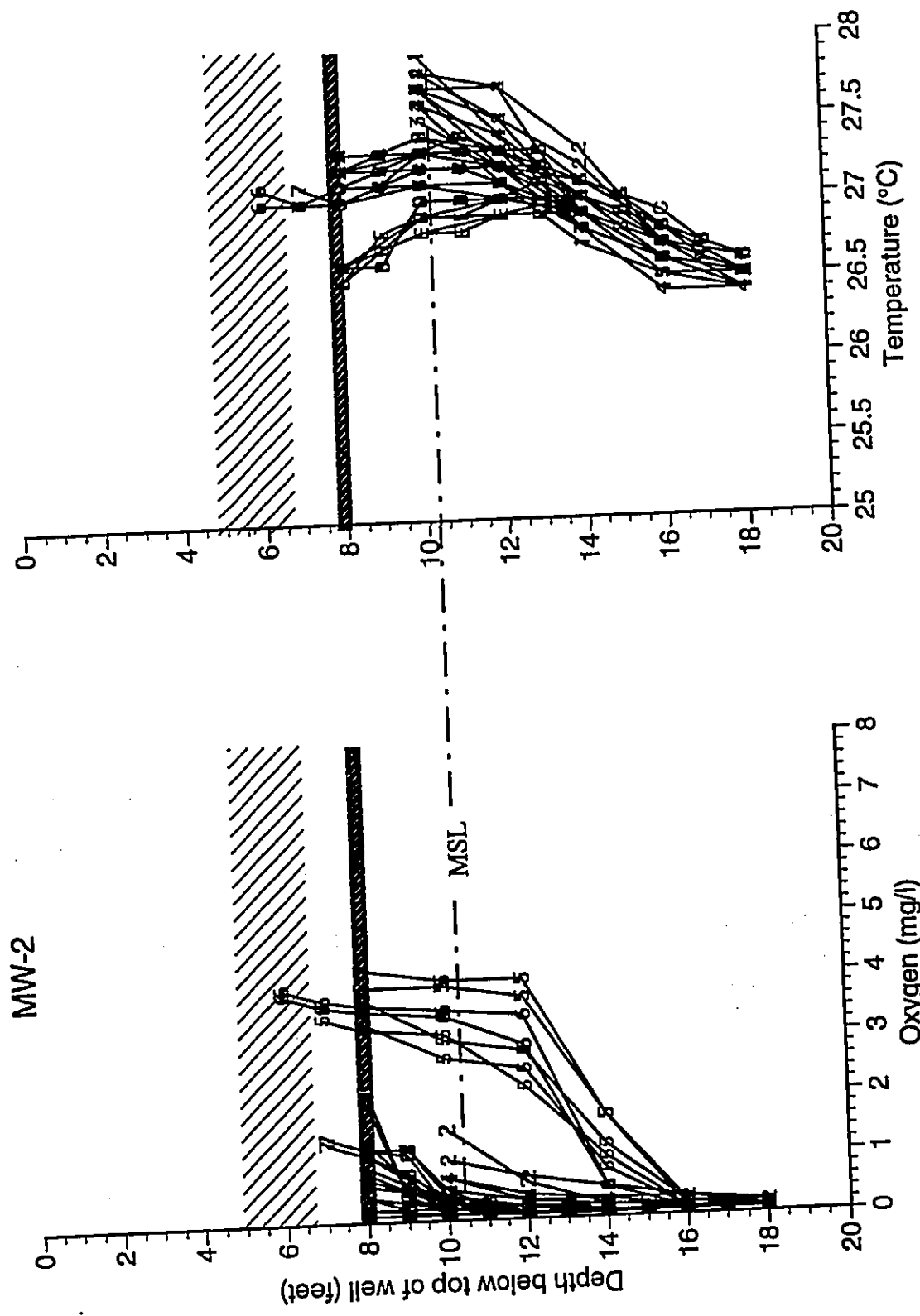

Figure 8(b). MW-2 temperature and dissolved oxygen profiles.

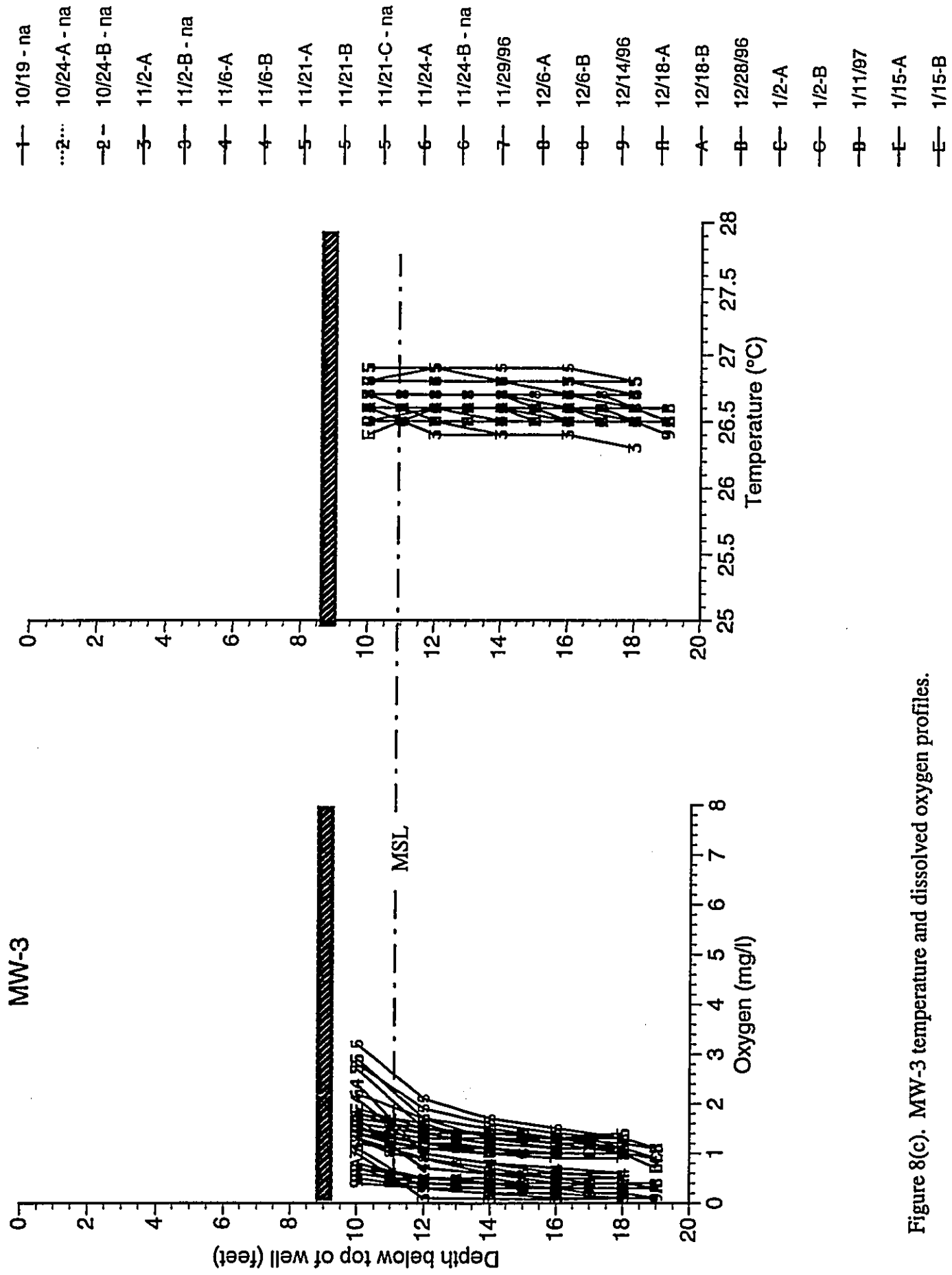

Figure 8(c). MW-3 temperature and dissolved oxygen profiles.

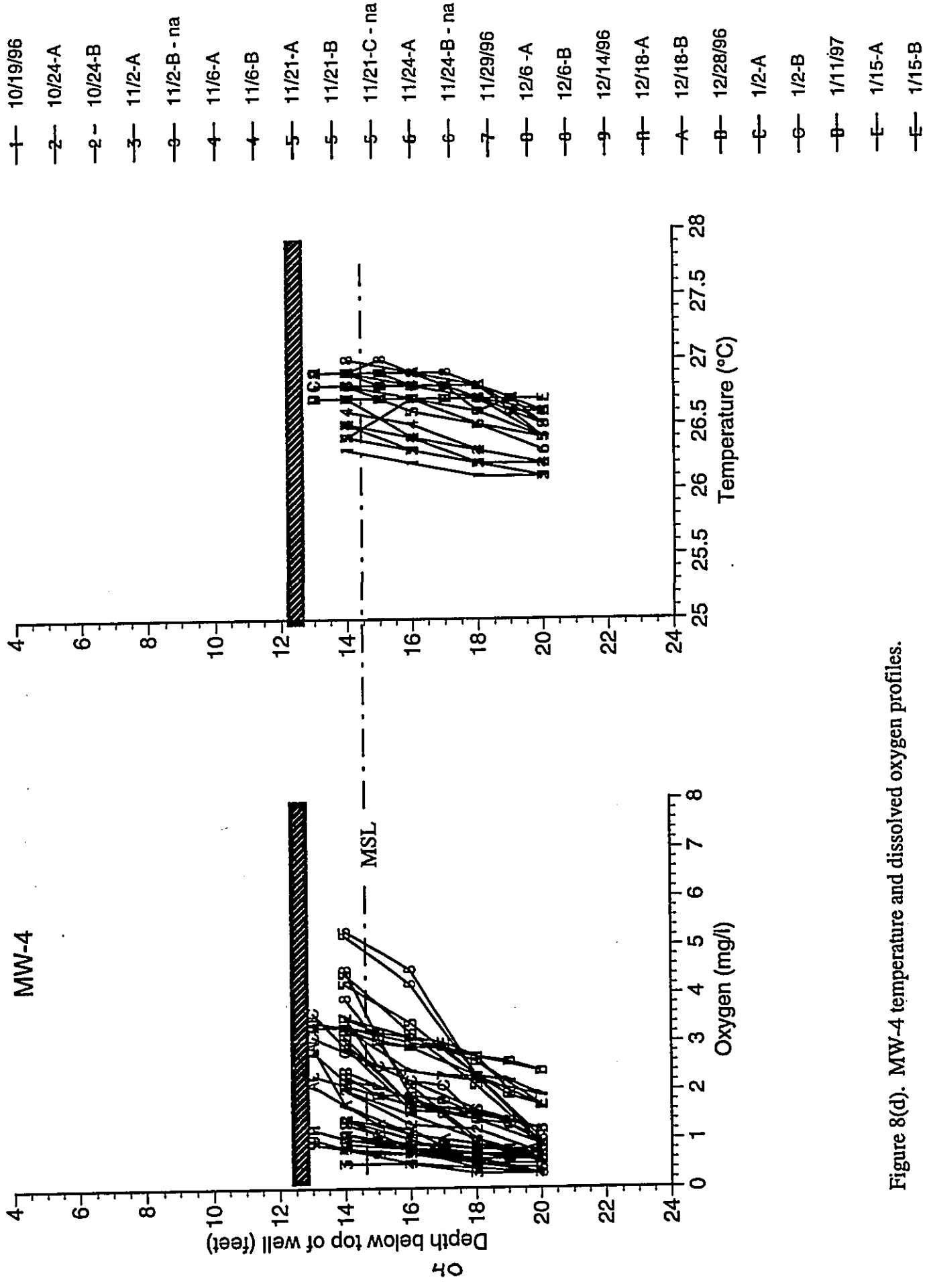

Figure 8(d). MW-4 temperature and dissolved oxygen profiles.

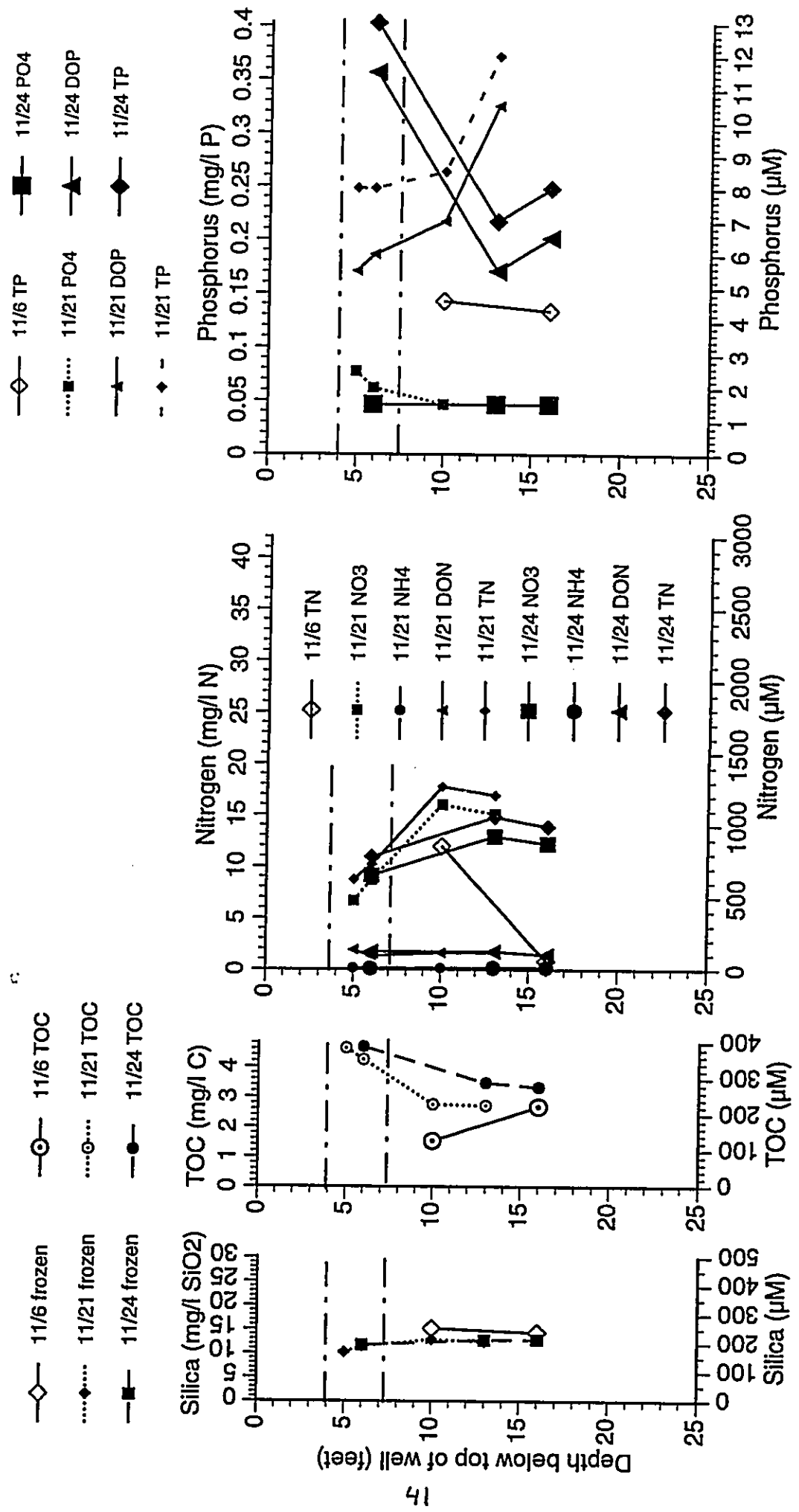

Figure 9(a). Pre- and post-storm nutrients in MW-1. To reduce clutter, only total N and total P are plotted for 11/6. Data from 11/24 are included to supplement 11/21 data, which did not extend below 13' depth. See Figure 5 for matching T/O₂ profiles, and Appendix 2 for complete nutrient data.

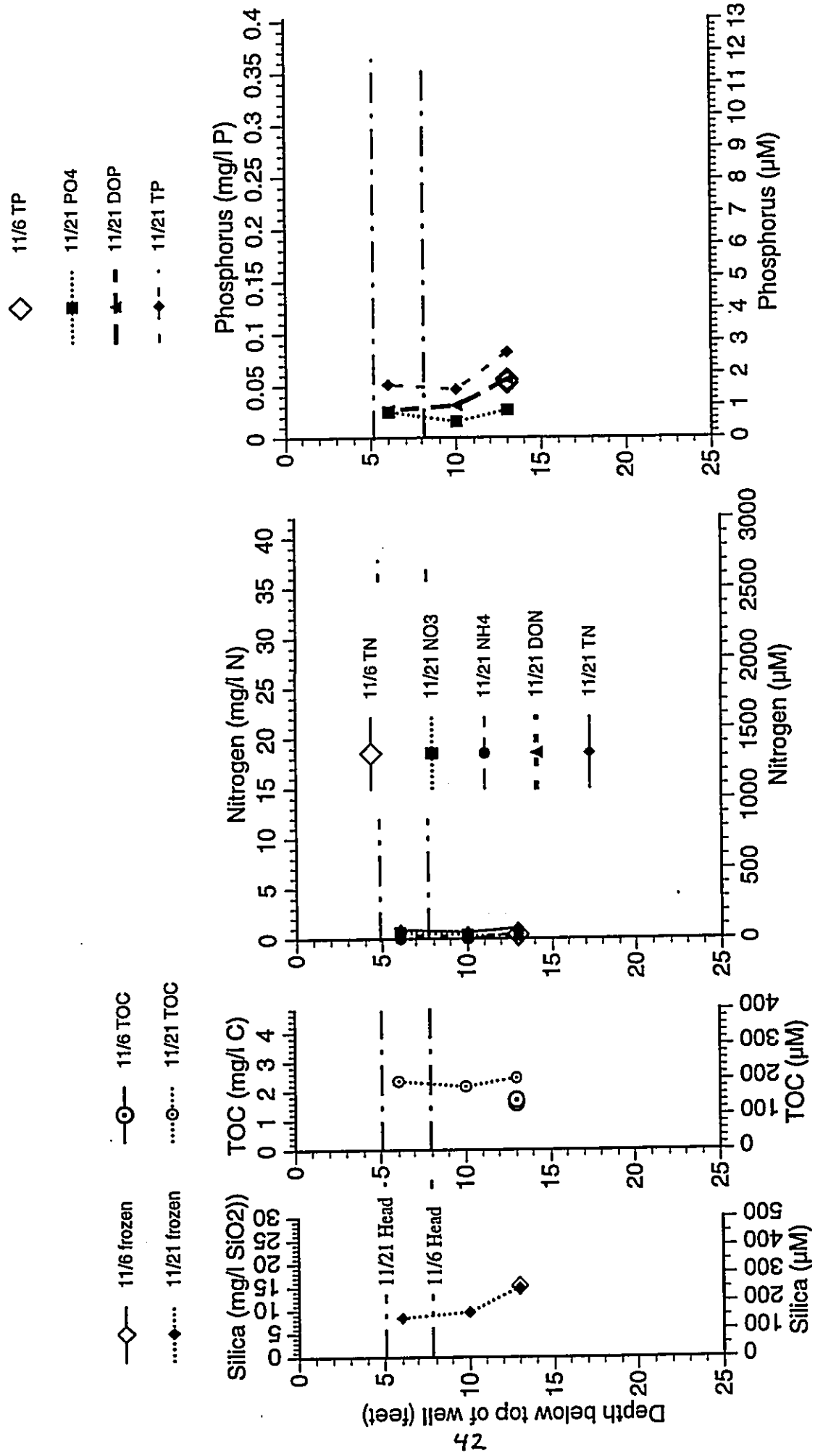
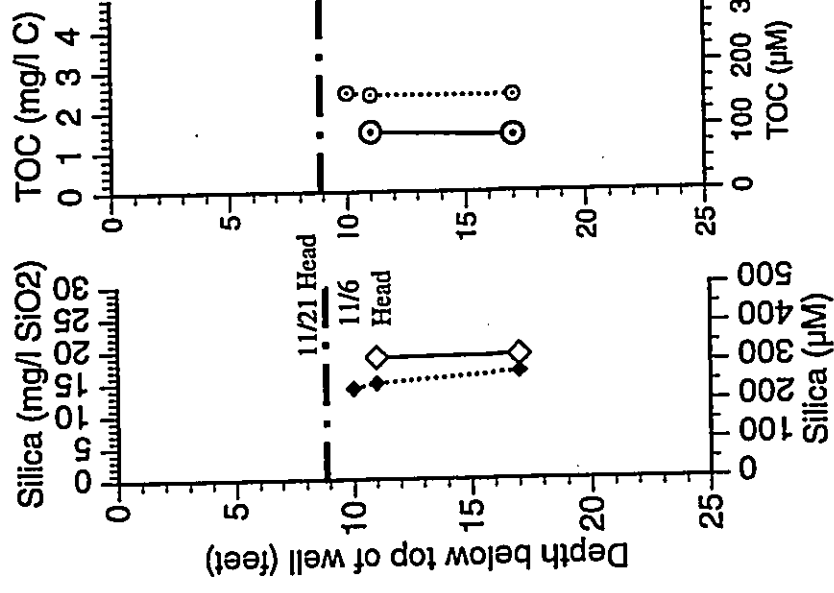
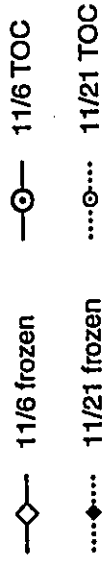
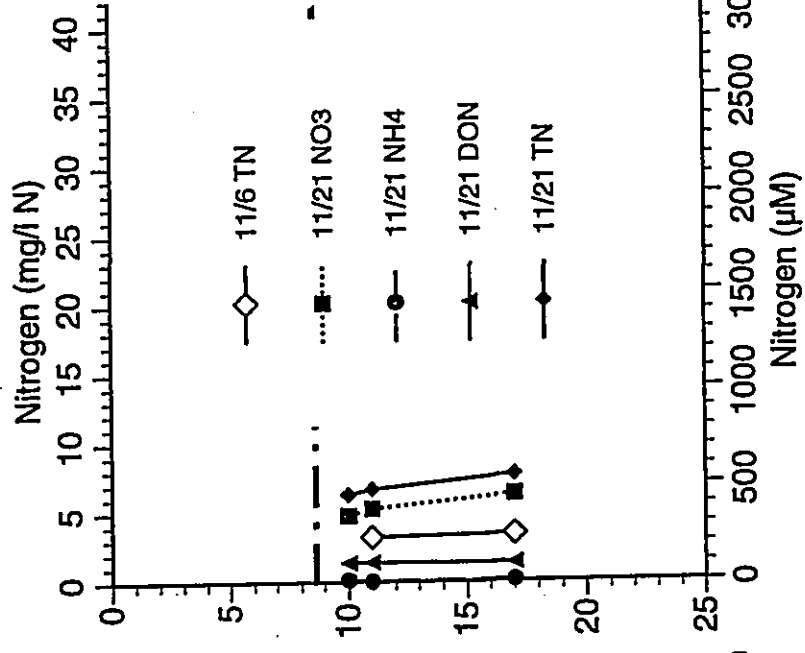
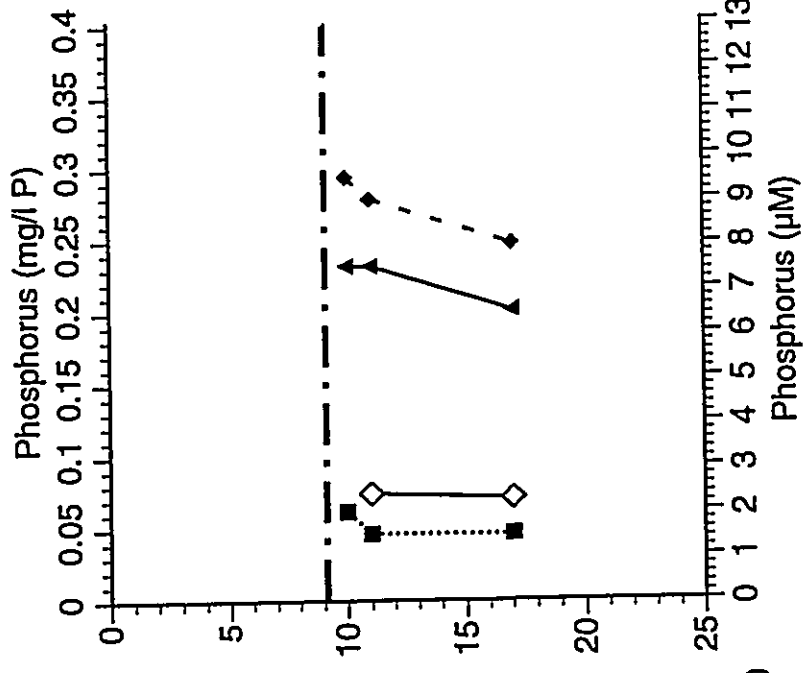
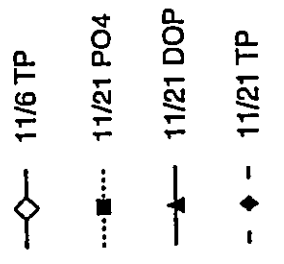

Figure 9(b). Pre- and post-storm nutrients in MW-2.



43

Figure 9(c). Pre- and post-storm nutrients in MW-3.

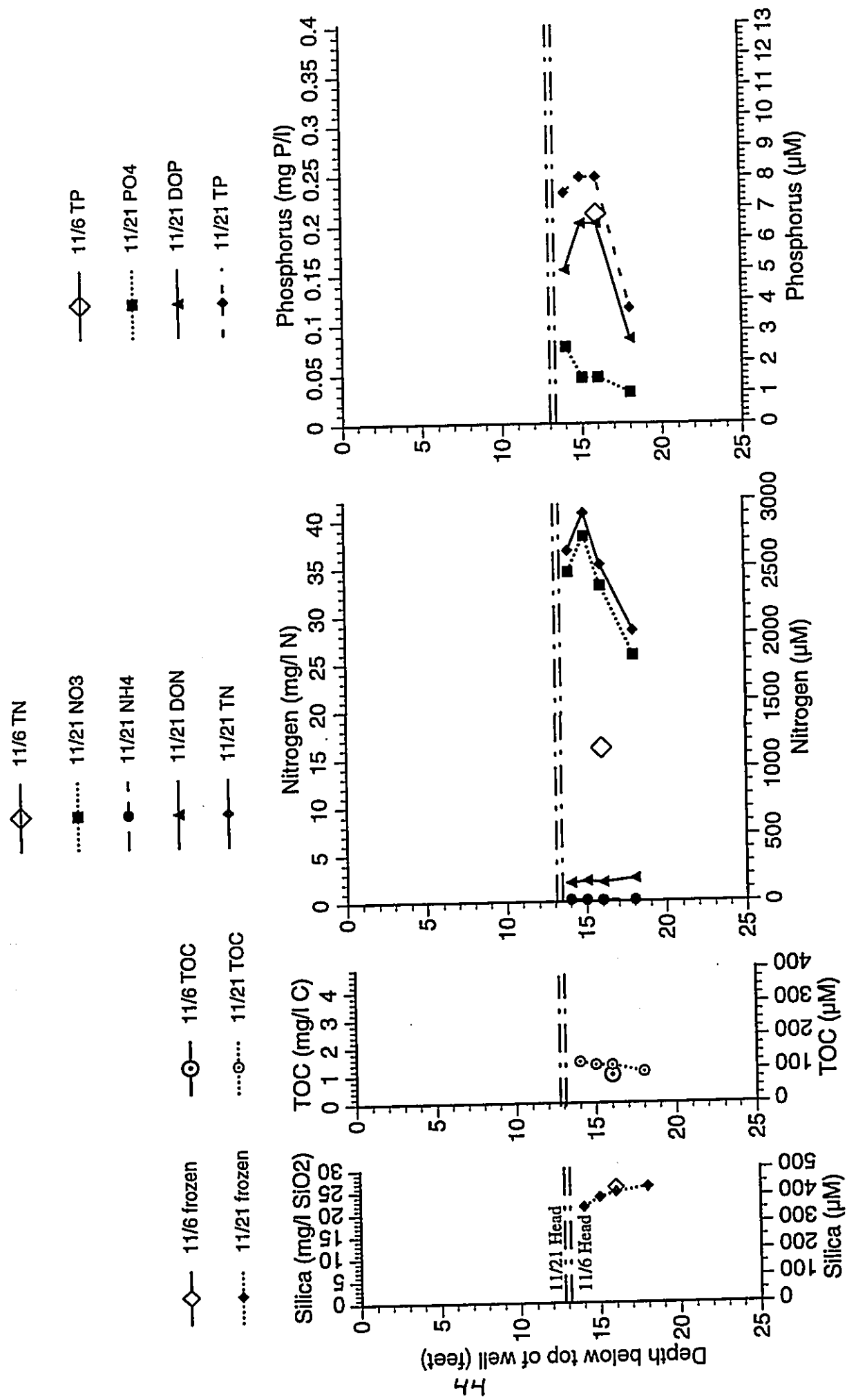

Figure 9(d). Pre- and post-storm nutrients in MW-4.

1- 11/6/96 2- 11/21/96 3- 11/24/96 4- 12/6/96 5- 12/18/96 6- 1/2/97 7- 1/15/97

Range of measured well heads

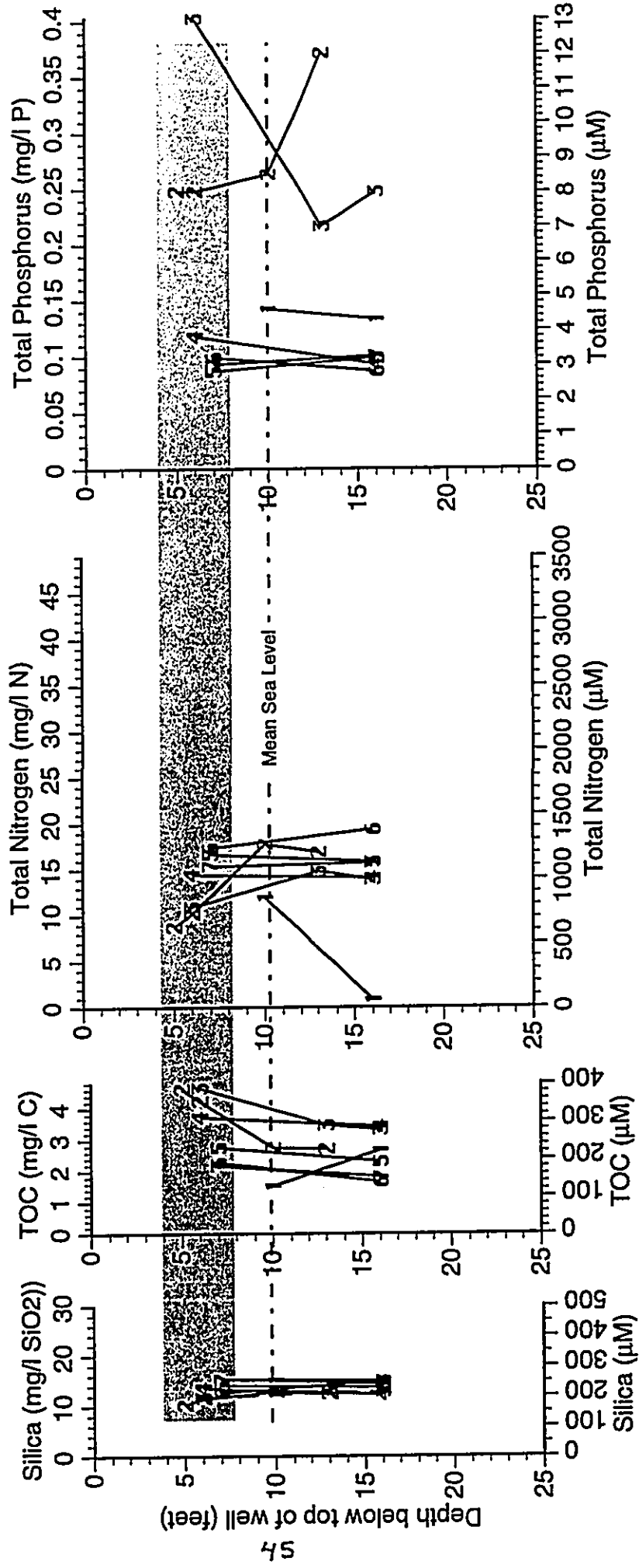

Figure 10(a). MW-1 depth profiles of silica (Si), total organic carbon (TOC), total nitrogen (TN), and total phosphorus (TP) over the study period.

1- 11/6/96 2- 11/21/96 3- 11/24/96 4- 12/6/96 5- 12/18/96 6- 1/2/97 7- 1/15/97

Range of measured well heads

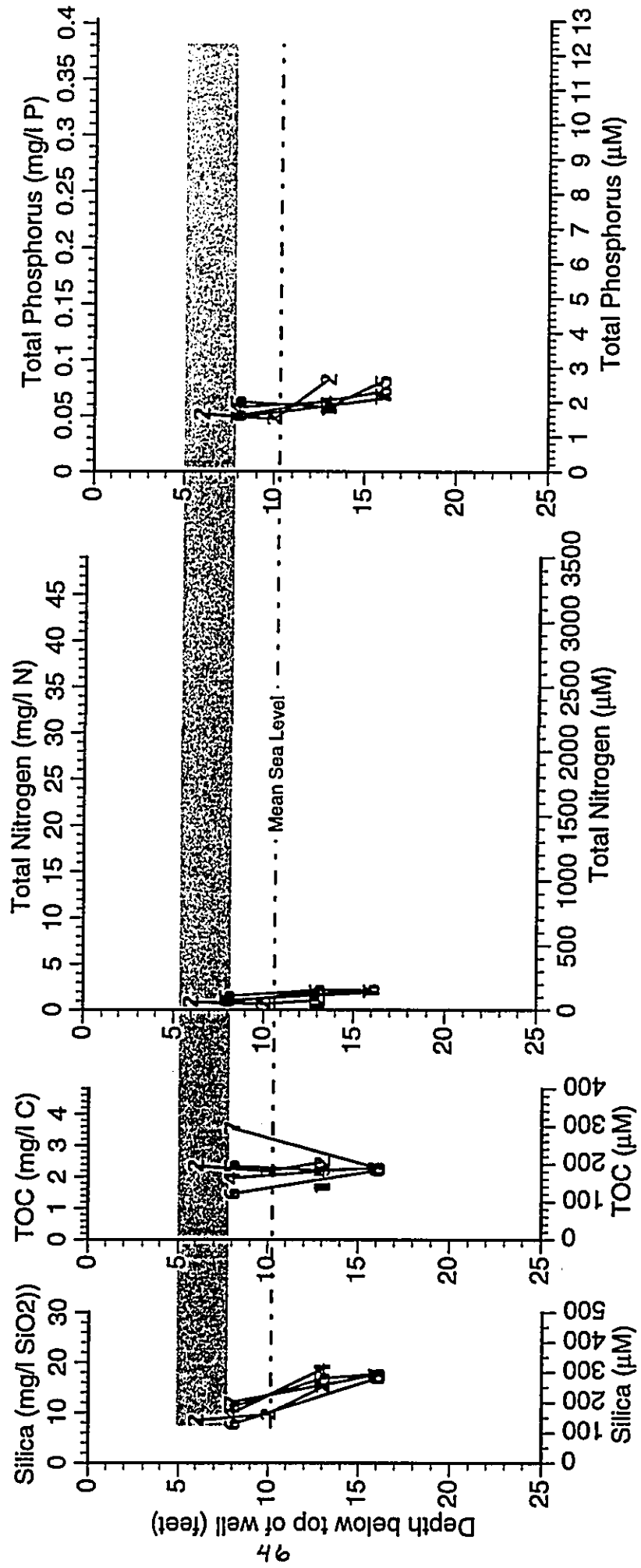

Figure 10(b). MW-2 depth profiles of silica (Si), total organic carbon (TOC), total nitrogen (TN), and total phosphorus (TP) over the study period.

1- 11/6/96 2- 11/21/96 3- 11/24/96 4- 12/6/96 5- 12/18/96 6- 1/2/97 7- 1/15/97

Range of measured well heads

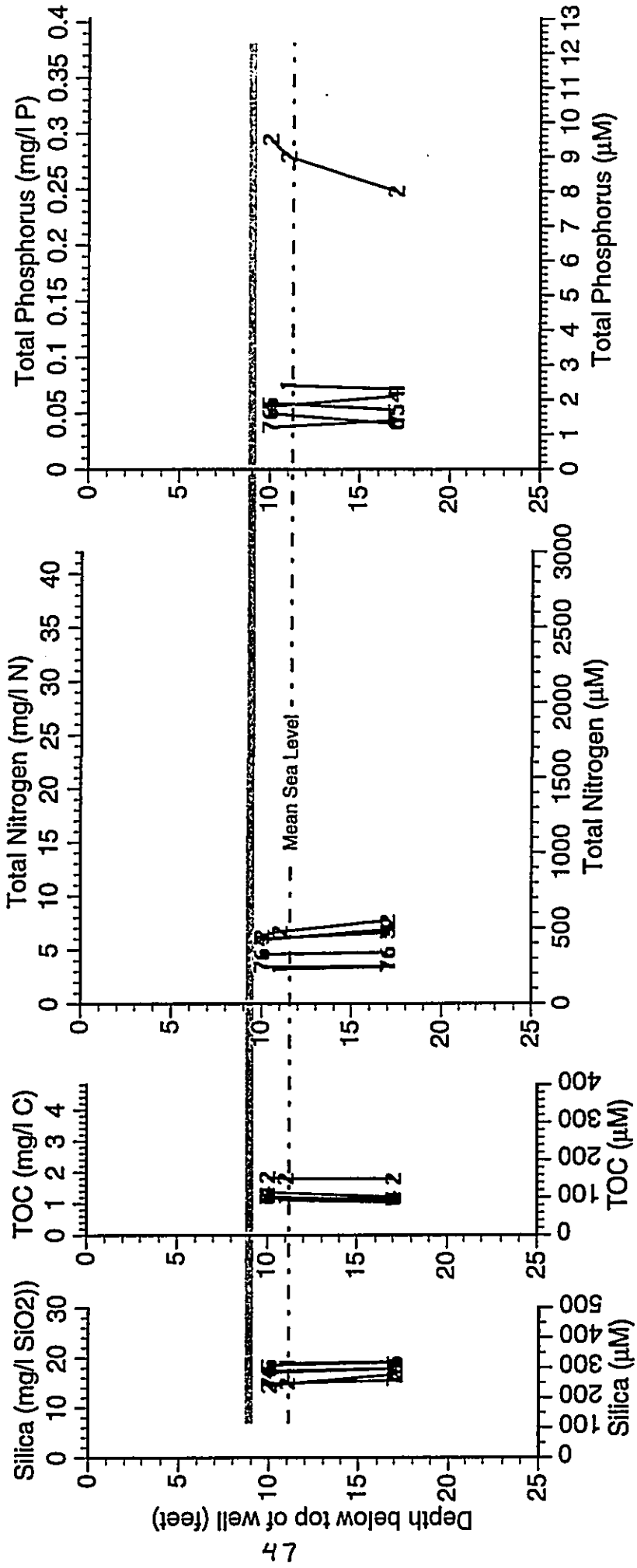

Figure 10(c). MW-3 depth profiles of silica (Si), total organic carbon (TOC), total nitrogen (TN), and total phosphorus (TP) over the study period.

1- 11/6/96 2- 11/21/96 3- 11/24/96 4- 12/6/96 5- 12/18/96 6- 1/2/97 7- 1/15/97

Range of measured well heads

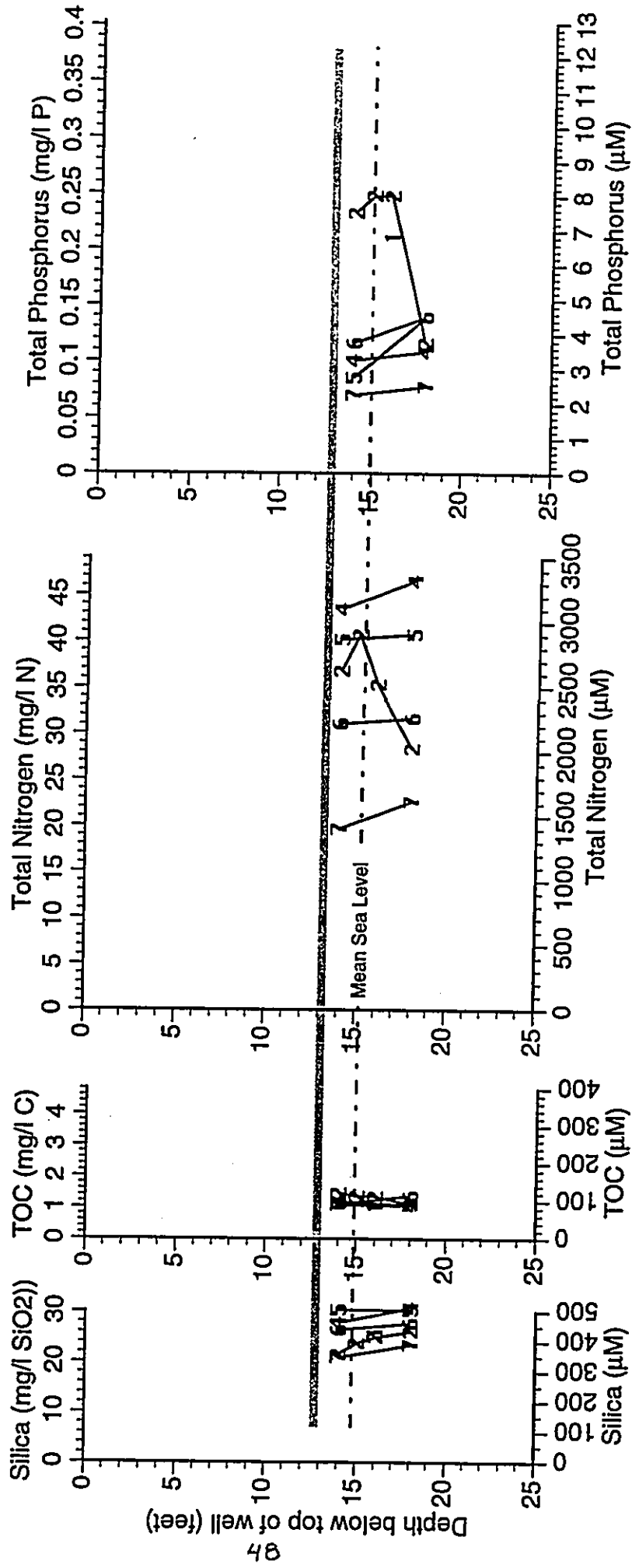

Figure 10(d). MW-4 depth profiles of silica (Si), total organic carbon (TOC), total nitrogen (TN), and total phosphorus (TP) over the study period.

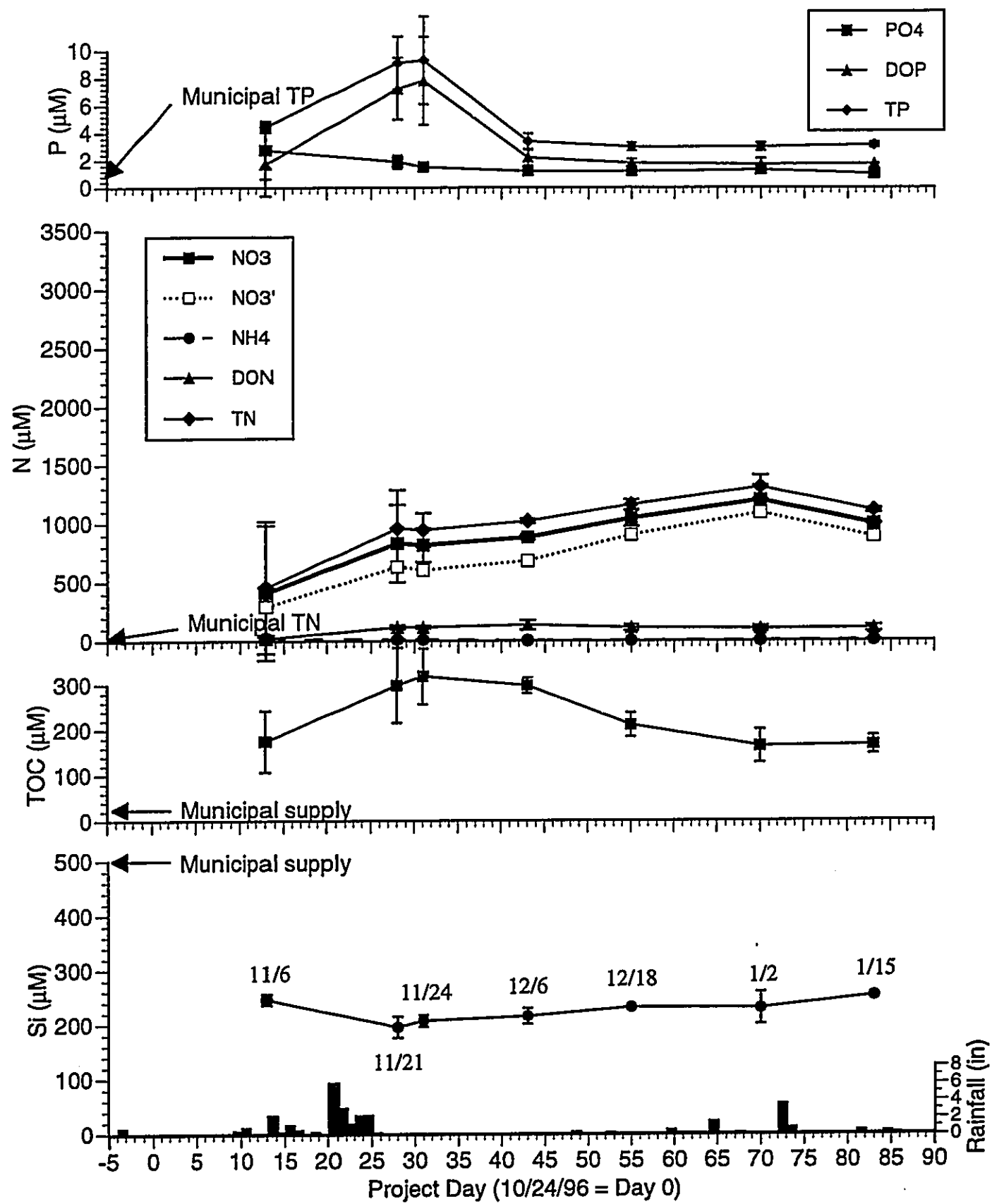

Figure 11(a). MW-1 nutrient concentrations over the study period. NO_3' is calculated as the nitrate that would remain after all of the TOC was consumed via denitrification. Points for each date are the means of all sampled depths, with error bars set at ± 1 standard deviation. Because samples at different depths are not replicates, error bars represent down-well variability.

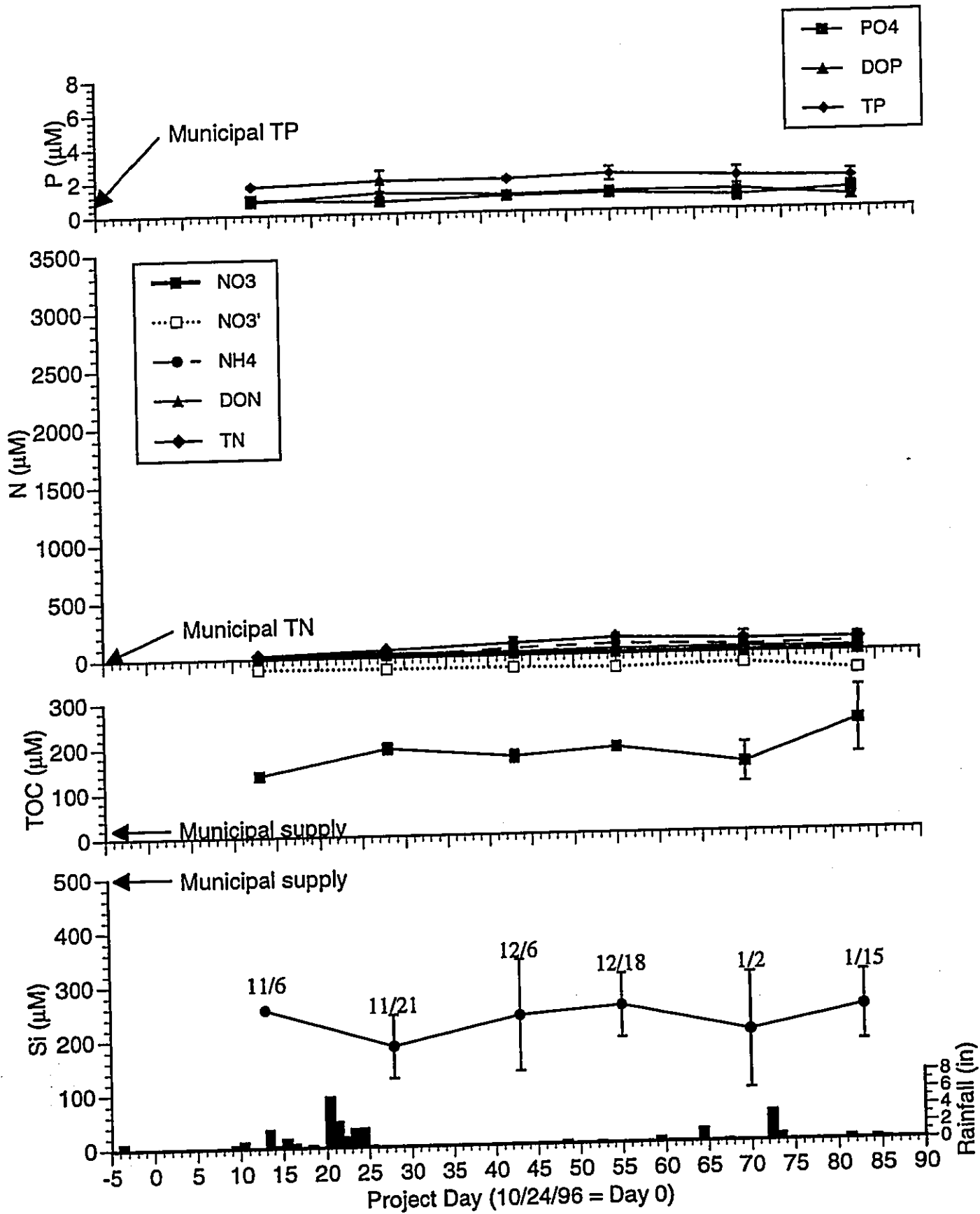

Figure 11(b). MW-2 nutrient concentrations over the study period. Error bars are as in (a), except on 11/6 where 3 samples were collected at a single depth, but separated by 8 liter "purgues". Error bars on this date thus represent variability associated with volume pumped. NO3' values are negative because TOC significantly exceeds the levels required to consume available nitrate via denitrification.

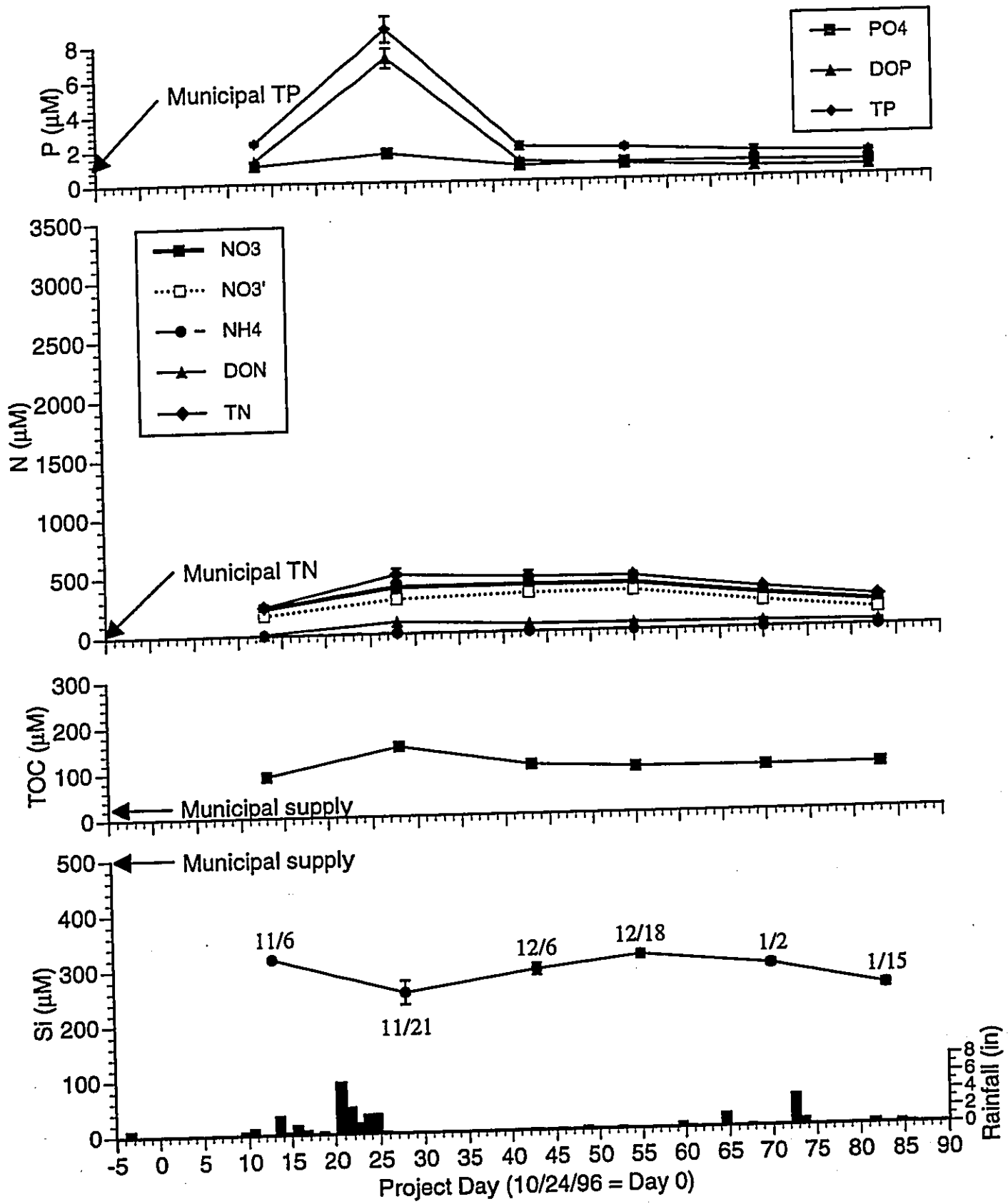

Figure 11(c). MW-3 nutrient concentrations over the study period. Error bars are as in (a), with extremely low values consistent with the near-vertical depth profiles in this well.

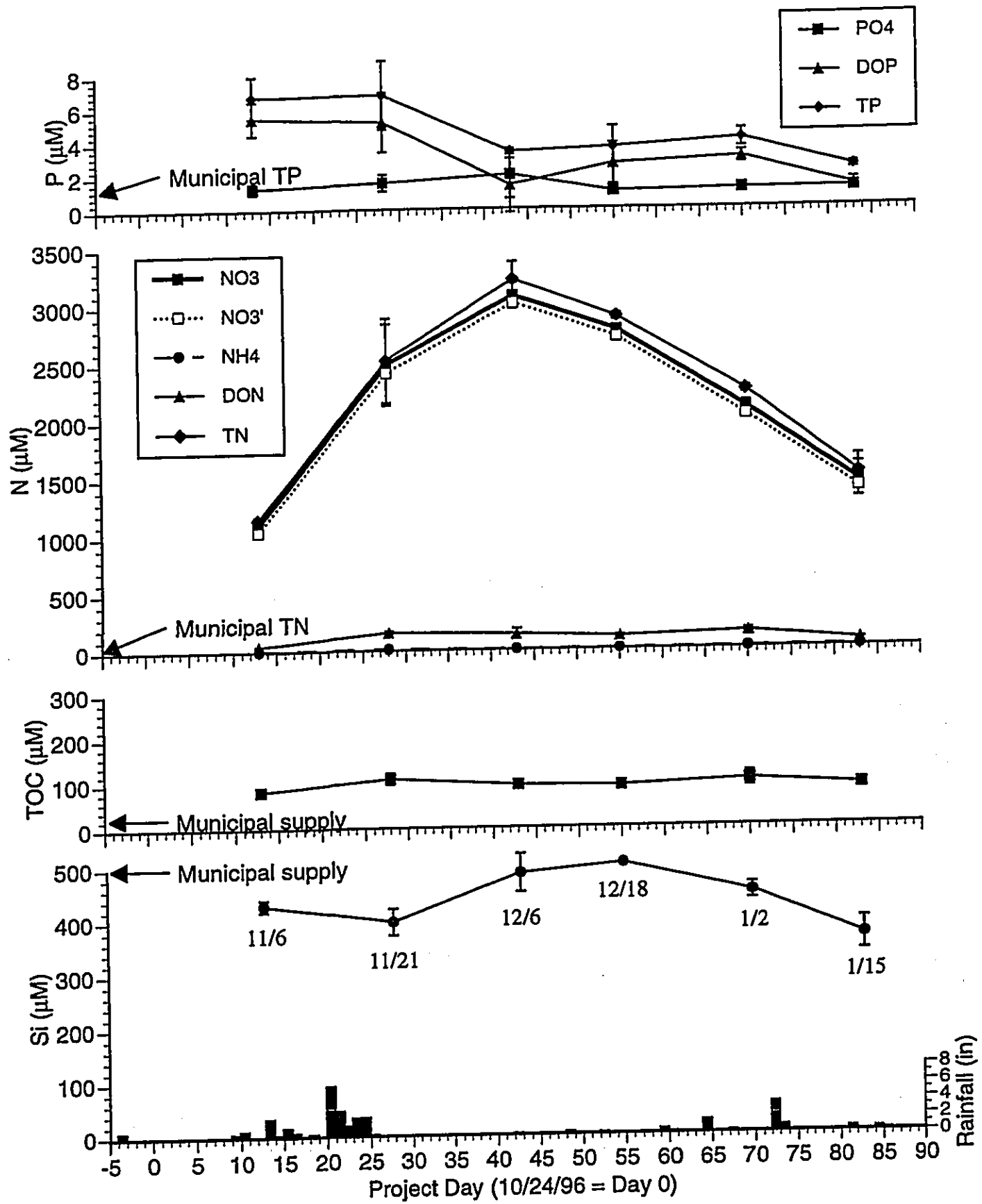

Figure 11(d). MW-4 nutrient concentrations over the study period. Error bars are as in (a), except that only one replicated sample was collected at a single depth on the first sampling date. Error bars on this date represent between-replicate variability.

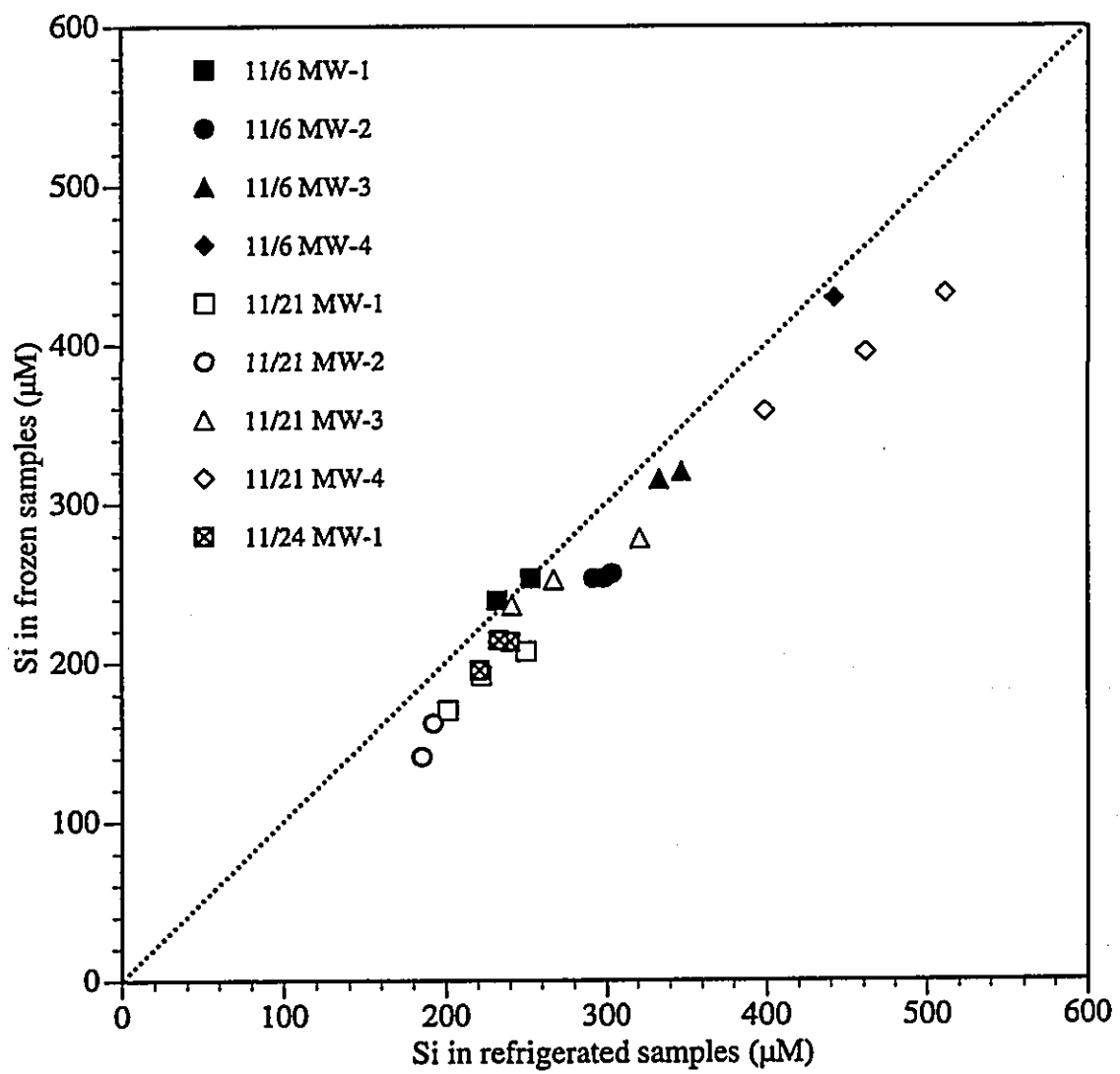

Figure 12. Silica levels in frozen and refrigerated samples. Frozen samples commonly exhibited significantly lower silica levels than refrigerated samples (accurate values would fall on the dashed line), but significant differences in silica levels between individual wells can be determined from either set of measurements.

Table 1. Water samples collected from Waimanalo monitoring wells. F = sample frozen for nutrient and Si analysis, R = sample split refrigerated for Si and/or salinity analysis, B = sample processed immediately for bacterial and physical parameters.

MW-1																					
Depth	10/24	11/6/96 (2)			11/21/96			11/24/96		12/6/96			12/18/96			1/2/97			1/15/97		
(1)	B	F	R	B	F	R	B	F	R	F	R	B	F	R	B	F	R	B	F	R	B
5					X	X		x	X												
6					X	X		X	X	X	x										
7					x					x	x					X	x		X	x	
8					x					x	x				X	x		X	x		X
9					x	X				x	x				X	x		X	x		X
10		X	X		X			x	X	x	x				X	x		X	x		X
11					X					x	x				X	x		X	x		X
12					x					x	x				X	x		X	x		X
13				X	X	X	X	X	X	x	x	X	x	x	X	x	x	X	x	x	X
14					X					X	X				X	x		X	x		X
15										X	X				X	x		X	x		X
16		X	X					X	X	X	x				X	x		X	x		X

MW-2																					
Depth	10/24	11/6/96			11/21/96			11/24/96		12/6/96			12/18/96			1/2/97			1/15/97		
(1)	B	F	R	B	F	R	B	F	R	F	R	B	F	R	B	F	R	B	F	R	B
6					X	X															
7					x (4)	X (4)															
8					x					X	x				X	x		X	x		X
9					x					x	x	X			X	x		X	x		X
10					X	X				x	x				X	x		X	x		X
11					x					x	x				X	x		X	x		X
12					x					x	x				X	x		X	x		X
13		X (3)	X (3)	X	X		X			X	x	X	X	x	X	x	x	X	x	x	X
14	X					X (5)									X	x		X	x		X
15															X	x		X	x		X
16															X	x		X	x		X

MW-3																					
Depth	10/24	11/6/96			11/21/96			11/24/96		12/6/96			12/18/96			1/2/97			1/15/97		
(1)	B	F	R	B	F	R	B	F	R	F	R	B	F	R	B	F	R	B	F	R	B
10					X	X				X	x				X	x		X	x		X
11		X	X		X	X				x	x				X	x		X	x		X
12					x					x	x				X	x		X	x		X
13					x					x	x				X	x		X	x		X
14				X	x		X			x	x	X	x	x	X	x	x	X	x	x	X
15					x					x	x				X	x		X	x		X
16					x					x	x				X	x		X	x		X
17		X	X		X	X				X	x				X	x		X	x		X

MW-4																					
Depth	10/24	11/6/96			11/21/96			11/24/96		12/6/96			12/18/96			1/2/97			1/15/97		
(1)	B	F	R	B	F	R	B	F	R	F	R	B	F	R	B	F	R	B	F	R	B
14					X	X				X	x				X	x		X	x		X
15	X				X	X				x	x				X	x		X	x		X
16		X	X	X	X		X			x	x	X	x	x	X	x	x	X	x	x	X
17					x					x	x				X	x		X	x		X
18					X	X				X	x				X	x		X	x		X

- X = sample analyzed
x = sample archived for later analysis if necessary
(1) Depth from top of well.
(2) All 11/6 samples collected and analyzed in replicate except bacterial samples
(3) Pumping effects analyzed at this depth: three replicate samples collected in sequence, separated by ~8 liters each
(4) Two samples: one from 1 PM and one from 5 PM.
(5) Sample left over from 1 PM sampling. May represent water from 13' due to lack of tubing flush prior to collection at 14'.

Table 2. Waimanalo head data (1). Average head differences between MW-1 and MW-2 and between MW-3 and MW-4 are shown to highlight the different magnitudes of the along-shore gradients in the mauka and makai regions. Averages use data from 12/6 and later to minimize the influence of measurement errors on earlier dates (see text for details).

Date	MW-1		MW-2		MW-1/2	MW-3		MW-4		MW-3/4	
	Day	Head (m)	Day	Head (m)	Head Δ (cm)	Day	Head (m)	Day	Head (m)	Head Δ (cm)	
10/24/96	0	na	0.444	0.67	na	0	na	0.378	0.56	na	
11/2/96	9.542	0.55 (2)	9.562	0.69	-14 (2)	9.594	0.68	9.576	0.67	1	
11/6/96	13.653	0.76	13.594	0.75	1	13.688	0.65	13.729	0.61	4	
11/21/96	28.594	1.755	28.708	1.585	17	28.639	0.675	28.677	0.665	1.0	
11/24/96	31.608	1.656	31.583	1.434	22.2	31.658	0.657	31.677	0.652	0.5	
11/29/96	36.656	1.503	36.635	1.243	26	36.677	0.581	36.691	0.570	1.1	
12/6/96	43.451	1.313	43.385	1.043	27	43.521	0.596	43.576	0.567	2.9	
12/14/96	51.410	1.135	51.399	0.896	23.9	51.427	0.652	51.438	0.611	4.1	
12/18/96	55.424	1.06	55.376	0.853	20.7	55.479	0.643	55.521	0.606	3.7	
12/27/96	64.521	1.084	64.517	0.869	21.5	64.528	0.636	64.533	0.603	3.3	
12/28/96	65.538	1.141	65.524	0.888	25.3	65.552	0.6	65.562	0.575	2.5	
1/2/97	70.361	1.154	70.316	0.905	24.9	70.417	0.654	70.465	0.621	3.3	
1/3/97	71.757	1.24	71.753	0.988	25.2	71.746	0.571	71.750	0.540	3.1	
1/11/97	79.375	1.287	79.358	1.051	23.6	79.392	0.62	79.408	0.583	3.7	
1/15/97	83.410	1.208	83.364	0.972	23.6	83.483	0.614	83.531	0.570	4.4	
1/19/97	87.594	1.172	87.590	0.929	24.3	87.601	0.576	87.604	0.551	2.5	
≥12/6 mean:					24.0	≥12/6 mean:					3.4

(1) Accuracies are estimated to be ± 1 to 2 cm through 11/21 (except see note (2)) and ± 0.2 to 0.4 cm for later dates, with the lowest values applicable to 12/6 and later dates due to increased efforts to determine the gradient between MW-3 and MW-4.

(2) Value questionable.

Table 3. Bacteriological and physical data for Waimanalo monitoring wells.

Date	Sample		Depth (1) (feet)	Bacteria				F-RNA bacterio- phage (PFU/100 ml)	Physical Parameters			Salinity (precision) (%)
	Well	Fecal coliform		<i>E. coli</i> (CFU/1000 ml)	Enterococci (CFU/1000 ml)	<i>C. perfringens</i>	Heterotrophic plate count (10 ⁶ CFU/l)		pH	Turbidity (NTU)	Salinity (refractometer) (%)	
10/24/96	MW-2	NA	14	0	NA	0	NA	0	7.85	17.0	2	NA
	MW-4	NA	15	0	NA	0	NA	0	7.69	23.0	2	NA
11/6/96	MW-1	0	13	2	50	4	3.60	0	8.06	3.20	2	0.67 (2)
	MW-2	0	13	0	8	0	16.0	0	7.88	2.70	2	1.28 (3)
	MW-3	148	14	80	3040	2	1.20	0	8.02	7.60	2	0.56 (4)
	MW-4	144	16	74	1440	0	26.8	0	7.89	24.0	2	0.58 (5)
11/21/96	MW-1	0	13	0	6	0	1.20	NA	7.60	0.80	1	NA (8)
	MW-2	0	13	0	>5000	0	2.76	NA	7.97	23.0	1	NA (8)
	MW-3	0	14	0	0	0	0.024	NA	7.73	1.00	1	NA (8)
	MW-4	0	16	0	4	0	0.087	NA	7.62	0.62	1	NA (8)
12/6/96	MW-1	0	13	0	0	0	12.1	NA	7.70	2.80	1	NA (8)
	MW-2	0	13	0	0	0	1.39	NA	7.74	6.00	1	NA (8)
	MW-2a	0	9	0	0	0	13.6	NA	8.02	1.30	1	NA (8)
	MW-3	0	14	0	0	0	0.90	NA	7.81	4.90	1	NA (8)
12/18/96	MW-4	0	16	0	0	0	0.70	NA	7.65	2.00	1	NA (8)
	MW-1	0	13	0	0	0	34.4	NA	7.95	2.20	1	NA (8)
	MW-2	0	13	0	0	0	1.10	NA	7.93	5.80	1	NA (8)
	MW-3	0	14	0	0	0	122	NA	8.13	18.0	1	NA (8)
1/2/97	MW-4	0	16	0	0	0	122	NA	7.91	2.00	1	NA (8)
	MW-1	0	13	NA	0	0	0.10	NA	NA	NA	NA	NA (8)
	MW-2	0	13	NA	0	0	0.17	NA	NA	NA	NA	NA (8)
	MW-3	0	14	NA	0	0	0.12	NA	NA	NA	NA	NA (8)
1/15/97	MW-4	0	16	NA	2	2	0.27	NA	NA	NA	NA	NA (8)
	MW-1	0	13	NA	0	0	0.62	NA	7.71	2.00	1	NA (8)
	MW-2	0	13	NA	0	0	3.22	NA	7.83	4.70	1	NA (8)
	MW-3	6	14	NA	0	0	>2.00	NA	7.93	12.0	1	NA (8)
	MW-4	1	16	NA	1	1	>2.00	NA	7.82	0.70	1	NA (8)

NA = not analyzed

(1) Depth below top of well pipe

(2) 10' depth

(3) 16' depth

(4) 13' depth

(5) 11' depth

(6) 17' depth

(7) 16' depth

(8) Archived sample available for analysis - see Table 1.

Table 4. Geometric mean concentrations of fecal indicator bacteria and F-RNA bacteriophage recovered from various sources in Hawaii (WRRC unpublished data).

Source	No. of samples	Fecal Bacteria					F-RNA bacteriophage (PFU/100 ml)
		Fecal coliform	E. coli	Fecal Streptococcus	Enterococcus	C. perfringens	
		(10 ³ CFU/100 ml)					
Cesspools	10	800	NA	130	NA	NA	NA
Storm Drains	14	29	NA	21	NA	NA	NA
Primary Effluent (Sand Island)	13	17000	15000	NA	980	22	105,000
Secondary Effluent (Mokapu)	18	NA	3,500	NA	200	16	NA
Waimanalo Stream	7	3.9	3.9	NA	4.0	3.9	NA

NA = not analyzed

Appendix A
Temperature/Oxygen Data and Profiles

MW-1 Temperature Data ("A" data are pre-sampling, "B" are post-sampling, "C" data on 11/21 were obtained after a second sampling sequence at MW-2 only.)

Depth (ft)	10/19		10/24		11/2			11/6			11/21			11/24			11/29		12/6		12/14		12/18		12/28		1/2		1/11		1/15		
	A	B	A	B	A	B	C	A	B	A	B	A	B	A	B	A	B	A	B	A	B	A	B	A	B	A	B	A	B				
3																																	
4																																	
5																																	
6																																	
7																																	
8																																	
9																																	
10																																	
11																																	
12																																	
13																																	
14																																	
15																																	
16																																	
17																																	
18																																	
19																																	
18																																	
16																																	
14																																	
12																																	
11																																	
10																																	
9																																	
8																																	
7																																	
6																																	
5																																	
4																																	
3																																	

MW-1 Dissolved Oxygen Data

Depth (ft)	10/19		10/24		11/2		11/6		11/21		11/24		11/29		12/6		12/14		12/18		12/28		1/2		1/11		1/15			
	A	B	A	B	A	B	A	B	A	B	A	B	A	B	A	B	A	B	A	B	A	B	A	B	A	B	A	B		
3					7.5	8.1					7.5	8.0	7.6		7.9	8.0	7.7	7.7	8.0	7.7	8.0	7.5	7.7	8.2	7.7	7.7	8.2	7.7	8.2	
4					6.3	6.1					6.2	6.3	5.5		6.2	5.7	4.4	2.4	2.0	2.4	2.4	3.3	3.6	3.4	3.7	3.2	3.0	3.2	4.3	
5											5.9	5.4	5.5		5.1	3.9	3.4	2.4	1.6	2.4	2.4	3.2	3.5	2.7	3.1	2.8	3.1	2.6	2.6	
6											4.9	3.9	5.4		4.8	2.7	3.1	2.4	1.4	2.4	2.4	2.7	1.7	1.9	3.0	2.7	3.0	1.9	1.9	
7											4.9	3.9	5.0		4.8	2.4	2.1	2.4	1.3	2.4	2.4	0.5	1.0	1.1	3.0	2.7	3.0	1.5	1.5	
8											4.1	3.3	4.8		4.7	2.2	1.9	2.4	1.2	2.4	2.4	0.4	1.0	0.8	3.0	2.7	3.0	1.4	1.4	
9											4.1	3.3	4.7		4.5	2.1	1.6	2.2	1.1	2.2	2.2	0.2	0.3	0.6	2.5	2.2	2.5	1.3	1.3	
10											3.2	3.1	4.3		4.5	2.0	1.4	1.8	1.1	1.8	1.8	0.1	0.1	0.5	1.7	1.6	1.7	1.4	1.4	
11											2.6	2.8	4.0		4.3	2.4	1.4	1.5	1.2	1.5	1.5	0.1	0.1	0.3	1.6	1.6	1.6	1.3	1.3	
12											0.8	1.2	3.5		4.1	2.9	1.4	1.3	1.3	1.3	1.3	0.1	0.1	0.2	1.4	1.2	1.4	1.2	1.2	
13											0.8	1.2	3.5		3.9	3.1	1.3	1.1	1.1	1.1	1.1	0.1	0.1	0.1	1.1	0.9	1.1	1.0	1.0	
14											0.8	1.2	3.5		3.7	3.3	1.1	0.9	0.9	0.9	0.9	0.1	0.1	0.1	0.9	0.8	0.9	0.8	0.8	
15											0.8	1.2	1.4		1.6	1.8	0.7	0.4	0.5	0.4	0.4	0.1	0.1	0.1	0.1	0.3	0.3	0.3	0.3	0.3
16											0.8	1.2	1.4		0.7	0.7	0.1	0.1	0.1	0.1	0.1	0.1	0.1	0.1	0.1	0.1	0.1	0.1	0.1	0.1
17											0.8	1.2	1.4		3.8	3.1	1.2	1.1	1.0	1.0	1.1	0.1	0.1	0.1	1.1	0.9	1.1	0.9	0.9	0.9
18											2.4	2.6	3.4		4.3	2.4	1.4	1.5	1.2	1.4	1.5	0.1	0.1	0.3	1.5	1.3	1.5	1.3	1.3	
19											3.1	3.0	4.0		4.5	2.1	1.6	2.1	1.1	1.6	2.1	0.1	0.3	0.6	2.3	2.1	2.3	2.1	1.3	
20											4.9	3.8	4.9		4.7	2.4	2.2	2.4	1.2	1.2	2.4	0.7	1.2	1.2	2.9	2.6	2.9	2.6	1.5	
21											5.8	5.0	5.4		5.0	3.1	3.3	2.4	1.6	1.6	2.4	2.7	3.0	3.0	3.1	2.8	3.1	2.8	2.7	
22											6.0	5.8	5.5		5.4	3.8	3.9	2.5	1.8	1.8	2.5	3.1	3.4	3.4	3.3	3.2	3.3	3.2	3.2	3.5
23											7.4	7.7	7.4		5.5	4.2	4.2													

MW-2 Temperature Data

Depth (ft)	10/19		10/24		11/2		11/6		11/21			11/24		11/29		12/6		12/14		12/18		12/28		1/2		1/11		1/15							
	A	B	A	B	A	B	A	B	A	B	C	A	B	A	B	A	B	A	B	A	B	A	B	A	B	A	B	A	B						
5					32.4		23.2	27.2	25.4	26.5	22.9	28.1		29.5	22.2	24.3	25.6	24.2	21.3	22.1	25.7	24.2	21.3	22.1	23.0	20.7	22.9								
6											27.0	27.1		27.1	27.1	27.1	27.1	27.2	27.1	27.2	27.2	27.2	27.1	27.0	26.6	26.5	26.5	26.6	26.6	26.7					
7							23.9	27.3	27.0	27.0	27.0	27.0		27.1	27.1	27.1	27.3	27.2	27.1	27.3	27.3	27.3	27.2	27.2	27.0	26.8	26.8	26.9	26.8	26.8	26.8				
8			24.3	33.7	31.6									27.2	27.2	27.2	27.3	27.3	27.3	27.3	27.4	27.3	27.3	27.3	27.2	27.0	26.8	26.8	26.9	26.8	26.8				
9					27.7		27.6	27.7	27.1	27.1	27.1	27.1		27.2	27.2	27.2	27.3	27.3	27.4	27.3	27.3	27.4	27.3	27.3	27.2	27.0	26.8	26.8	26.9	26.8	26.9	26.9			
10	27.9		27.4	27.8	27.7		27.4	27.7	27.1	27.1	27.1	27.1		27.1	27.2	27.2	27.2	27.2	27.3	27.3	27.3	27.3	27.3	27.2	27.1	27.0	26.9	26.9	27.0	26.9	26.9				
11	27.4		27.2	27.7	27.2		27.0	26.9	26.9	26.9	26.9	26.9		26.9	27.0	27.0	27.0	27.0	27.1	27.1	27.2	27.2	27.1	27.1	27.0	26.9	26.9	27.0	26.9	27.0	26.9	27.0			
12	26.8		26.9	27.3	27.0		27.0	26.9	26.7	26.7	26.7	26.7		26.7	26.8	26.7	26.7	26.7	26.7	26.7	26.7	26.8	26.8	26.8	26.7	26.7	26.8	26.8	26.9	26.8	26.8	26.8			
13							26.7	26.7	26.7	26.7	26.7	26.7		26.7	26.7	26.7	26.7	26.7	26.7	26.7	26.7	26.8	26.8	26.7	26.7	26.7	26.7	26.8	26.8	26.8	26.8	26.8			
14							26.4	26.5	26.5	26.5	26.5	26.5		26.5	26.5	26.5	26.5	26.5	26.5	26.5	26.5	26.5	26.6	26.6	26.6	26.6	26.6	26.6	26.6	26.6	26.6	26.6	26.6		
15							26.4	26.6	26.6	26.6	26.6	26.6		26.6	26.6	26.6	26.6	26.6	26.6	26.6	26.6	26.6	26.6	26.6	26.6	26.6	26.6	26.6	26.6	26.6	26.6	26.6	26.6		
16							26.4	26.5	26.5	26.5	26.5	26.5		26.5	26.5	26.5	26.5	26.5	26.5	26.5	26.5	26.5	26.5	26.5	26.5	26.5	26.5	26.5	26.5	26.5	26.5	26.5	26.5		
17							26.4	26.6	26.6	26.6	26.6	26.6		26.6	26.6	26.6	26.6	26.6	26.6	26.6	26.6	26.6	26.6	26.6	26.6	26.6	26.6	26.6	26.6	26.6	26.6	26.6	26.6		
18							26.5	26.7	26.7	26.7	26.7	26.7		26.7	26.7	26.7	26.7	26.7	26.7	26.7	26.7	26.7	26.7	26.7	26.7	26.7	26.7	26.7	26.7	26.7	26.7	26.7	26.7		
19							26.5	26.8	26.8	26.8	26.8	26.8		26.8	26.8	26.8	26.8	26.8	26.8	26.8	26.8	26.8	26.8	26.8	26.8	26.8	26.8	26.8	26.8	26.8	26.8	26.8	26.8	26.8	
20							26.7	27.2	27.2	27.2	27.2	27.2		27.2	27.2	27.2	27.2	27.2	27.2	27.2	27.2	27.2	27.2	27.2	27.2	27.2	27.2	27.2	27.2	27.2	27.2	27.2	27.2	27.2	
21							27.3	27.5	27.5	27.5	27.5	27.5		27.5	27.5	27.5	27.5	27.5	27.5	27.5	27.5	27.5	27.5	27.5	27.5	27.5	27.5	27.5	27.5	27.5	27.5	27.5	27.5	27.5	
22							27.3	27.8	27.8	27.8	27.8	27.8		27.8	27.8	27.8	27.8	27.8	27.8	27.8	27.8	27.8	27.8	27.8	27.8	27.8	27.8	27.8	27.8	27.8	27.8	27.8	27.8	27.8	
23							27.7	27.8	27.8	27.8	27.8	27.8		27.8	27.8	27.8	27.8	27.8	27.8	27.8	27.8	27.8	27.8	27.8	27.8	27.8	27.8	27.8	27.8	27.8	27.8	27.8	27.8	27.8	
24							27.7	27.9	27.9	27.9	27.9	27.9		27.9	27.9	27.9	27.9	27.9	27.9	27.9	27.9	27.9	27.9	27.9	27.9	27.9	27.9	27.9	27.9	27.9	27.9	27.9	27.9	27.9	
25							27.8	27.9	27.9	27.9	27.9	27.9		27.9	27.9	27.9	27.9	27.9	27.9	27.9	27.9	27.9	27.9	27.9	27.9	27.9	27.9	27.9	27.9	27.9	27.9	27.9	27.9	27.9	
26							27.8	27.9	27.9	27.9	27.9	27.9		27.9	27.9	27.9	27.9	27.9	27.9	27.9	27.9	27.9	27.9	27.9	27.9	27.9	27.9	27.9	27.9	27.9	27.9	27.9	27.9	27.9	
27							27.8	27.9	27.9	27.9	27.9	27.9		27.9	27.9	27.9	27.9	27.9	27.9	27.9	27.9	27.9	27.9	27.9	27.9	27.9	27.9	27.9	27.9	27.9	27.9	27.9	27.9	27.9	
28							27.8	27.9	27.9	27.9	27.9	27.9		27.9	27.9	27.9	27.9	27.9	27.9	27.9	27.9	27.9	27.9	27.9	27.9	27.9	27.9	27.9	27.9	27.9	27.9	27.9	27.9	27.9	
29							27.8	27.9	27.9	27.9	27.9	27.9		27.9	27.9	27.9	27.9	27.9	27.9	27.9	27.9	27.9	27.9	27.9	27.9	27.9	27.9	27.9	27.9	27.9	27.9	27.9	27.9	27.9	27.9
30							27.8	27.9	27.9	27.9	27.9	27.9		27.9	27.9	27.9	27.9	27.9	27.9	27.9	27.9	27.9	27.9	27.9	27.9	27.9	27.9	27.9	27.9	27.9	27.9	27.9	27.9	27.9	27.9
31							27.8	27.9	27.9	27.9	27.9	27.9		27.9	27.9	27.9	27.9	27.9	27.9	27.9	27.9	27.9	27.9	27.9	27.9	27.9	27.9	27.9	27.9	27.9	27.9	27.9	27.9	27.9	27.9
32							27.8	27.9	27.9	27.9	27.9	27.9		27.9	27.9	27.9	27.9	27.9	27.9	27.9	27.9	27.9	27.9	27.9	27.9	27.9	27.9	27.9	27.9	27.9	27.9	27.9	27.9	27.9	27.9
33							27.8	27.9	27.9	27.9	27.9	27.9		27.9	27.9	27.9	27.9	27.9	27.9	27.9	27.9	27.9	27.9	27.9	27.9	27.9	27.9	27.9	27.9	27.9	27.9	27.9	27.9	27.9	27.9
34							27.8	27.9	27.9	27.9	27.9	27.9		27.9	27.9	27.9	27.9	27.9	27.9	27.9	27.9	27.9	27.9	27.9	27.9	27.9	27.9	27.9	27.9	27.9	27.9	27.9	27.9	27.9	27.9
35							27.8	27.9	27.9	27.9	27.9	27.9		27.9	27.9	27.9	27.9	27.9	27.9	27.9	27.9	27.9	27.9	27.9	27.9	27.9	27.9	27.9	27.9	27.9	27.9	27.9	27.9	27.9	27.9

MW-2 Dissolved Oxygen Data

Depth (ft)	10/19		10/24		11/2		11/6		11/21		11/24		11/29		12/6		12/14		12/18		12/28		1/2		1/11		1/15		
	A	B	A	B	A	B	A	B	A	B	A	B	A	B	A	B	A	B	A	B	A	B	A	B	A	B	A	B	
5					6.8		8.2	7.7	7.9	7.9	7.9	8.6	7.6	7.4	8.3	7.9	7.8	8.4	8.4	7.9	8.0	8.5	8.6	8.2	8.6	8.6	8.6	8.4	
6												3.9	3.9	1.4															
7												3.4	3.7																
8			7.2		6.8		8.0	7.5	4.2	3.7	3.2	3.6	3.6	1.2	1.2	0.9	2.0	2.2	0.8	0.7	1.2	1.2	0.9	0.2	0.4	0.4	0.4	0.4	0.4
9							0.5	0.7	4.0	3.0	3.1	3.5	3.5	1.2	0.6	0.6	0.4	0.4	0.5	0.5	0.4	1.1	0.6	0.2	0.3	0.3	0.3	0.3	0.3
10	0.7		1.5		0.3		0.5	0.7	4.0	3.0	3.1	3.5	3.5	0.5	0.4	0.3	0.1	0.2	0.3	0.3	0.4	0.2	0.4	0.2	0.4	0.2	0.2	0.2	0.2
11							0.3	0.4	4.0	2.8	2.2	3.4	3.4	0.2	0.1	0.1	0.1	0.1	0.2	0.2	0.3	0.2	0.3	0.1	0.2	0.2	0.2	0.2	0.2
12	0.3		0.6		0.2		0.3	0.4	4.0	2.8	2.2	3.4	3.4	0.1	0.1	0.1	0.1	0.1	0.2	0.2	0.2	0.1	0.2	0.1	0.2	0.2	0.2	0.2	0.2
13							0.2	0.3	1.7	1.2	1.0	0.5	0.5	0.1	0.1	0.1	0.1	0.1	0.1	0.1	0.1	0.1	0.1	0.1	0.1	0.1	0.1	0.1	0.1
14							0.2	0.3	1.7	1.2	1.0	0.5	0.5	0.1	0.1	0.1	0.1	0.1	0.1	0.1	0.1	0.1	0.1	0.1	0.1	0.1	0.1	0.1	0.1
15							0.1	0.1	0.2	0.2	0.1	0.1	0.1	0.1	0.1	0.1	0.1	0.1	0.1	0.1	0.1	0.1	0.1	0.1	0.1	0.1	0.1	0.1	0.1
16	0.3		0.2		0.1		0.1	0.1	0.2	0.2	0.1	0.1	0.1	0.1	0.1	0.1	0.1	0.1	0.1	0.1	0.1	0.1	0.1	0.1	0.1	0.1	0.1	0.1	0.1
17							0.1	0.1	0.2	0.2	0.1	0.1	0.1	0.1	0.1	0.1	0.1	0.1	0.1	0.1	0.1	0.1	0.1	0.1	0.1	0.1	0.1	0.1	0.1
18	0.2		0.2		0.1		0.1	0.1	0.1	0.1	0.1	0.1	0.1	0.1	0.1	0.1	0.1	0.1	0.1	0.1	0.1	0.1	0.1	0.1	0.1	0.1	0.1	0.1	0.1
16	0.1		0.1		0.1		0.1	0.1	0.1	0.1	0.1	0.1	0.1	0.1	0.1	0.1	0.1	0.1	0.1	0.1	0.1	0.1	0.1	0.1	0.1	0.1	0.1	0.1	0.1
14	0.1		0.1		0.1		0.1	0.1	1.7	0.8		0.5	0.5	0.1	0.1	0.1	0.1	0.1	0.1	0.1	0.1	0.1	0.1	0.1	0.1	0.1	0.1	0.1	0.1
12	0.1		0.1		0.1		0.1	0.2	3.7	2.5		2.9	2.9	0.1	0.1	0.1	0.1	0.1	0.1	0.1	0.2	0.1	0.2	0.1	0.2	0.1	0.2	0.1	0.1
10	0.1		0.1		0.1		0.1	0.3	3.9	2.7		3.4	3.4	0.4	0.3	0.2	0.1	0.2	0.3	0.4	0.4	0.2	0.3	0.1	0.2	0.1	0.2	0.1	0.1
9									3.9	3.3		3.5	3.5	1.1	0.8	0.5	0.1	0.7	0.5	0.6	0.7	0.5	0.1	0.5	0.1	0.2	0.1	0.1	
8									3.9	3.3		3.6	3.6	1.3	1.1	0.7	1.3	1.3	0.7	0.7	0.6	1.1	0.7	0.1	0.2	0.1	0.1	0.1	
7									7.6	7.8		7.7	7.7																
6							7.1	7.2	7.6	7.8		7.7	7.7																
5									7.6	7.8		7.7	7.7																

MW-3 Temperature Data

Depth (ft)	10/19		10/24		11/2		11/6		11/21		11/24		11/29		12/6		12/14		12/18		12/28		1/2		1/11		1/15			
	A	B	A	B	A	B	A	B	A	B	A	B	A	B	A	B	A	B	A	B	A	B	A	B	A	B	A	B		
5					25.3	25.1	26.7	25.4	25.9		25.2	25.1	26.1	25.8	24.2	24.5	23.8	23.1	26.1	24.9	25.9									
8					25.4	25.3	26.7	25.4	26.8		26.8	26.7	26.7	26.6	26.6	26.6	26.5	26.5	26.5	26.5	26.5	26.5	26.5	26.5	26.5	26.5	26.5	26.5	26.5	26.4
10					26.6	26.6	26.9	26.8	26.8		26.8	26.7	26.7	26.6	26.6	26.6	26.6	26.6	26.5	26.5	26.5	26.5	26.5	26.5	26.5	26.5	26.5	26.5	26.5	26.5
11					26.6	26.6	26.9	26.9	26.8		26.8	26.7	26.7	26.6	26.6	26.6	26.6	26.6	26.6	26.5	26.5	26.5	26.5	26.5	26.5	26.5	26.5	26.5	26.5	26.5
12					26.6	26.6	26.8	26.9	26.8		26.8	26.7	26.7	26.6	26.6	26.6	26.6	26.6	26.6	26.5	26.5	26.5	26.5	26.5	26.5	26.5	26.5	26.5	26.5	26.5
13					26.6	26.6	26.8	26.9	26.8		26.8	26.7	26.7	26.6	26.6	26.6	26.6	26.6	26.6	26.5	26.5	26.5	26.5	26.5	26.5	26.5	26.5	26.5	26.5	26.5
14					26.6	26.6	26.8	26.9	26.8		26.8	26.7	26.7	26.6	26.6	26.6	26.6	26.6	26.6	26.5	26.5	26.5	26.5	26.5	26.5	26.5	26.5	26.5	26.5	26.5
15					26.5	26.6	26.8	26.9	26.7		26.8	26.6	26.7	26.6	26.6	26.6	26.6	26.6	26.6	26.5	26.5	26.5	26.5	26.5	26.5	26.5	26.5	26.5	26.5	26.5
16					26.5	26.6	26.8	26.9	26.7		26.8	26.6	26.7	26.6	26.6	26.6	26.6	26.6	26.6	26.5	26.5	26.5	26.5	26.5	26.5	26.5	26.5	26.5	26.5	26.5
17					26.5	26.5	26.8	26.8	26.7		26.7	26.6	26.6	26.5	26.5	26.5	26.5	26.5	26.5	26.5	26.5	26.5	26.5	26.5	26.5	26.5	26.5	26.5	26.5	26.5
18					26.5	26.5	26.8	26.8	26.7		26.7	26.6	26.6	26.5	26.5	26.5	26.5	26.5	26.5	26.5	26.5	26.5	26.5	26.5	26.5	26.5	26.5	26.5	26.5	26.5
19					26.5	26.5	26.8	26.8	26.7		26.7	26.6	26.6	26.5	26.5	26.5	26.5	26.5	26.5	26.5	26.5	26.5	26.5	26.5	26.5	26.5	26.5	26.5	26.5	26.5
18					26.5	26.5	26.8	26.8	26.7		26.7	26.6	26.6	26.5	26.5	26.5	26.5	26.5	26.5	26.5	26.5	26.5	26.5	26.5	26.5	26.5	26.5	26.5	26.5	26.5
16					26.5	26.5	26.8	26.8	26.7		26.7	26.6	26.6	26.5	26.5	26.5	26.5	26.5	26.5	26.5	26.5	26.5	26.5	26.5	26.5	26.5	26.5	26.5	26.5	26.5
14					26.5	26.6	26.8	26.8	26.8		26.8	26.7	26.7	26.6	26.6	26.6	26.6	26.6	26.6	26.5	26.5	26.5	26.5	26.5	26.5	26.5	26.5	26.5	26.5	26.5
12					26.6	26.6	26.9	26.9	26.8		26.8	26.7	26.7	26.6	26.6	26.6	26.6	26.6	26.6	26.5	26.5	26.5	26.5	26.5	26.5	26.5	26.5	26.5	26.5	26.5
11					26.6	26.6	26.9	26.9	26.8		26.8	26.7	26.7	26.6	26.6	26.6	26.6	26.6	26.6	26.5	26.5	26.5	26.5	26.5	26.5	26.5	26.5	26.5	26.5	26.5
10					26.6	26.6	26.9	26.9	26.8		26.8	26.7	26.7	26.6	26.6	26.6	26.6	26.6	26.6	26.5	26.5	26.5	26.5	26.5	26.5	26.5	26.5	26.5	26.5	26.5
8					26.6	26.6	26.9	26.9	26.8		26.8	26.7	26.7	26.6	26.6	26.6	26.6	26.6	26.6	26.5	26.5	26.5	26.5	26.5	26.5	26.5	26.5	26.5	26.5	26.4

MW-3 Dissolved Oxygen Data

Depth (ft)	10/19		10/24		11/2		11/6		11/21			11/24		11/29		12/6		12/14		12/18		12/28		1/2		1/11		1/15	
	A	A	B	B	A	B	A	B	A	B	C	A	B	A	B	A	B	A	B	A	B	A	B	A	B	A	B	A	B
5					7.4		8.1	8.2	7.6	8.0		7.8	7.9	7.8	7.9	7.8	7.8	8.1	8.1	7.8	8.1	8.0	8.0	8.0	8.3	7.6	7.9	8.0	
8					1.1		8.1	8.1	7.6	8.0		2.2		1.5	1.5	0.7	0.7	0.6	0.6	0.5	0.6	0.8	1.7	1.4	1.5	1.5	1.5	1.5	1.9
10							2.4	2.1	2.9	3.2				1.2	0.6	0.6	1.1	0.5	0.5	0.4	0.6	1.6	1.2	1.3	1.4	1.4	1.4	1.7	
11					0.3		1.0	1.0	1.7	2.1		1.7		1.2	0.5	0.9	0.9	0.4	0.4	0.3	0.4	1.5	1.1	1.2	1.3	1.3	1.3	1.6	
12														1.0	0.5	0.8	0.5	0.4	0.4	0.3	0.4	1.4	1.1	1.2	1.3	1.3	1.4	1.4	
13					0.2		0.8	0.8	1.5	1.7		1.3		1.0	0.5	0.7	0.4	0.4	0.3	0.3	0.4	1.4	1.1	1.1	1.1	1.3	1.3	1.4	
14														0.9	0.4	0.6	0.4	0.3	0.3	0.3	0.3	1.3	1.0	1.0	1.0	1.2	1.2	1.3	
15					0.1		0.6	0.7	1.3	1.5		1.1		0.9	0.4	0.5	0.3	0.3	0.3	0.3	0.3	1.3	1.0	1.0	1.0	1.2	1.2	1.3	
16														0.9	0.4	0.2	0.4	0.4	0.4	0.2	0.4	1.3	1.0	1.0	1.0	1.2	1.2	1.3	
17														0.9	0.4	0.2	0.4	0.3	0.3	0.2	0.4	1.3	1.0	1.0	1.0	1.0	1.0	1.1	
18														0.9	0.4	0.2	0.4	0.3	0.3	0.1	0.3	1.1	0.9	0.9	0.7	0.9	0.9	1.1	
19														0.9	0.4	0.1	0.4	0.4	0.3	0.3	0.3	1.2	1.0	1.0	1.0	1.0	1.1	1.3	
18														0.9	0.4	0.1	0.4	0.4	0.3	0.3	0.3	1.3	1.0	1.0	1.0	1.2	1.2	1.3	
16														0.9	0.4	0.2	0.4	0.4	0.3	0.3	0.3	1.3	1.0	1.0	1.0	1.2	1.2	1.3	
14														1.0	0.4	0.6	0.4	0.4	0.2	0.2	0.3	1.4	1.0	1.0	1.1	1.3	1.3	1.4	
12														1.1	0.5	0.9	0.5	0.4	0.2	0.3	0.4	1.4	1.1	1.2	1.3	1.3	1.3	1.5	
11														1.1	0.5	0.9	0.5	0.4	0.3	0.4	0.5	1.4	1.1	1.2	1.3	1.3	1.4	1.7	
10					1.0		1.6	1.7	2.7	2.8		1.8		1.4	0.5	1.0	0.5	0.4	0.4	0.4	0.5	1.6	1.1	1.2	1.4	1.4	1.4	1.7	
8					7.9		7.6	7.7	7.5	7.7		7.4		7.5	0.7	1.3	0.7	0.5	0.5	0.5	0.8	1.6	1.2	1.4	1.5	1.5	1.5	1.8	
5									7.9	7.9				7.5															

MW-4 Temperature Data

Depth (ft)	10/19		10/24		11/2		11/6		11/21			11/24		11/29		12/6		12/14		12/18		12/28		1/2		1/11		1/15		
	A	B	A	B	A	B	A	B	A	B	C	A	B	A	B	A	B	A	B	A	B	A	B	A	B	A	B	A	B	
5	29.7	27.2	30.7	25.4	24.9										24.8	25.7	24.8	26.2	24.5	24.3	24.5	24.3	24.5	24.5	23.5	24.8	27.7	27.8	25.5	
10	29.8	30.8	30.2	25.5	25.0					24.3		25.7			25.0		26.9	26.9	26.9	26.9	26.9	26.9	26.8	26.8	26.8	26.8	26.7	26.7	26.7	26.7
12	26.5	26.7	26.5	26.5	26.6					26.4		26.8			26.9	27.0	27.0	26.8	26.8	26.8	26.8	26.8	26.8	26.8	26.8	26.8	26.7	26.7	26.7	26.7
13	26.3	26.4	26.3	26.4	26.5					26.7		26.7			26.8	26.9	26.9	26.8	26.8	26.8	26.8	26.8	26.8	26.8	26.8	26.7	26.7	26.7	26.7	26.7
14	26.2	26.3	26.2	26.3	26.3					26.6		26.5			26.7	26.8	26.8	26.6	26.6	26.6	26.6	26.6	26.6	26.6	26.6	26.6	26.6	26.6	26.6	26.6
15	26.1	26.2	26.1	26.2	26.2					26.5		26.5			26.6	26.7	26.7	26.5	26.5	26.5	26.5	26.5	26.5	26.5	26.5	26.5	26.5	26.5	26.5	26.5
16	26.1	26.2	26.1	26.2	26.2					26.4		26.3			26.4	26.4	26.4	26.7	26.7	26.7	26.7	26.7	26.7	26.7	26.7	26.7	26.7	26.7	26.7	26.7
17	26.1	26.2	26.1	26.2	26.3					26.5		26.5			26.5	26.5	26.5	26.8	26.8	26.8	26.8	26.8	26.8	26.8	26.8	26.8	26.8	26.8	26.8	26.8
18	26.1	26.2	26.1	26.2	26.3					26.6		26.6			26.6	26.6	26.6	26.8	26.8	26.8	26.8	26.8	26.8	26.8	26.8	26.8	26.8	26.8	26.8	26.8
19	26.1	26.2	26.1	26.2	26.3					26.5		26.5			26.6	26.6	26.6	26.7	26.7	26.7	26.7	26.7	26.7	26.7	26.7	26.7	26.7	26.7	26.7	26.7
20	26.1	26.2	26.1	26.2	26.3					26.4		26.4			26.4	26.4	26.4	26.7	26.7	26.7	26.7	26.7	26.7	26.7	26.7	26.7	26.7	26.7	26.7	26.7
20	26.1	26.2	26.1	26.2	26.3					26.5		26.5			26.5	26.5	26.5	26.8	26.8	26.8	26.8	26.8	26.8	26.8	26.8	26.8	26.8	26.8	26.8	26.8
18	26.1	26.2	26.1	26.2	26.3					26.6		26.6			26.6	26.6	26.6	26.9	26.9	26.9	26.9	26.9	26.9	26.9	26.9	26.9	26.9	26.9	26.9	26.9
16	26.2	26.3	26.3	26.4	26.4					26.8		26.8			26.8	26.8	26.8	27.0	27.0	27.0	27.0	27.0	27.0	27.0	27.0	27.0	27.0	27.0	27.0	27.0
14	26.3	26.4	26.4	26.5	26.5					26.8		26.8			26.9	26.9	26.9	27.0	27.0	27.0	27.0	27.0	27.0	27.0	27.0	27.0	27.0	27.0	27.0	27.0
13	26.3	26.4	26.4	26.5	26.5					26.8		26.8			26.9	26.9	26.9	27.0	27.0	27.0	27.0	27.0	27.0	27.0	27.0	27.0	27.0	27.0	27.0	27.0
12	26.3	26.6	26.5	26.5	26.5					26.8		26.8			26.9	26.9	26.9	27.0	27.0	27.0	27.0	27.0	27.0	27.0	27.0	27.0	27.0	27.0	27.0	27.0
10	26.4	26.6	26.6	26.5	26.5					26.8		26.8			26.9	26.9	26.9	27.0	27.0	27.0	27.0	27.0	27.0	27.0	27.0	27.0	27.0	27.0	27.0	27.0
5	26.5	26.6	26.5	26.5	26.5					26.8		26.8			26.8	26.8	26.8	27.0	27.0	27.0	27.0	27.0	27.0	27.0	27.0	27.0	27.0	27.0	27.0	27.0

MW-4 Dissolved Oxygen Data

Depth (ft)	10/19		10/24		11/2		11/6		11/21			11/24		11/29		12/6		12/14		12/18		12/28		1/2		1/11		1/15						
	A	B	A	B	A	B	A	B	A	B	C	A	B	A	B	A	B	A	B	A	B	A	B	A	B	A	B	A	B					
5	7.3	7.9	7.3	7.4	8.0	8.2									7.8	8.0	8.0	8.0	7.8	8.3	8.0	8.0	8.0	8.0	8.0	8.0	7.9	7.3	7.4	7.7				
10	7.3	7.8	7.3	7.4	8.0	8.1									7.7				1.0	8.3														
12	2.0	3.0	2.0	0.8	0.9	1.4									3.5	4.5	4.5	4.5	0.8	1.1	1.7	1.7	2.3	2.9	2.8	3.6	3.4	3.3	3.5					
13	1.5	1.7	1.3	0.7	0.8	1.2									2.5	3.1	3.1	3.1	0.7	1.0	1.3	1.3	1.9	2.1	2.5	2.9	3.3	3.0	3.2					
14	1.0	1.4	1.2	0.5	0.6	0.5									2.4	1.9	1.9	1.9	0.7	0.9	1.1	1.1	1.9	1.8	2.2	2.2	3.1	2.9	3.1					
15	0.5	0.9	0.7	0.4	0.3	0.3									2.3	1.5	1.5	1.5	0.7	0.9	1.0	1.0	1.8	1.6	2.1	2.1	2.9	2.9	3.0					
16	0.5	0.5	0.7	0.3	0.4	0.4									2.3	0.7	0.9	0.9	0.7	0.8	0.9	0.9	1.5	1.4	1.4	1.4	2.7	2.3	2.7					
18	0.5	0.5	0.7	0.3	0.3	0.3									2.2	0.6	0.7	0.8	0.6	0.8	0.8	0.8	1.4	1.3	1.3	1.3	2.6	1.9	2.0					
20	0.5	0.5	0.7	0.4	0.3	0.3									1.9	0.6	0.6	0.7	0.6	0.8	0.8	0.7	1.2	0.9	1.0	1.0	2.4	1.7	1.7					
20	0.5	0.5	0.7	0.3	0.4	0.4									2.2	0.7	1.0	1.0	0.6	0.8	0.9	0.9	1.5	1.4	1.6	1.6	2.7	2.3	2.6					
18	0.8	1.0	0.8	0.5	0.5	0.8									2.4	0.8	2.1	2.1	0.7	0.9	1.1	1.1	1.8	1.7	2.2	2.2	3.0	2.9	3.1					
16	1.0	1.4	1.0	0.5	0.8	1.1									3.3	1.4	3.9	3.9	0.8	1.0	1.7	1.7	2.4	2.1	2.8	2.8	3.3	3.2	3.5					
14	7.5	7.0	7.6	7.9	7.5	7.4													0.9	1.2	2.1	2.1	2.4	2.1	3.1	3.1	3.3	3.2	3.5					
13																																		
12																																		
10																																		
5															7.6																			

MW-2: 10/19/96

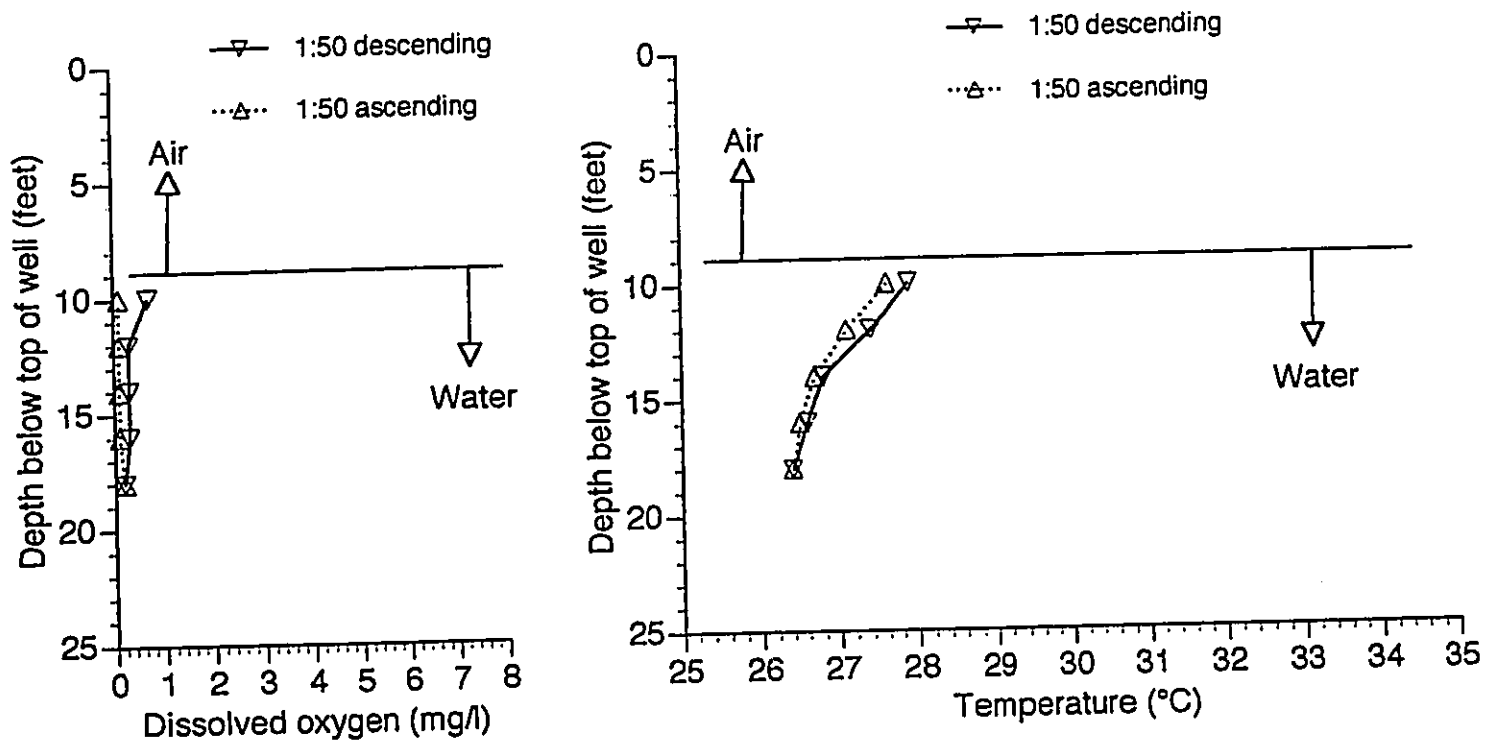

MW-4: 10/19/96

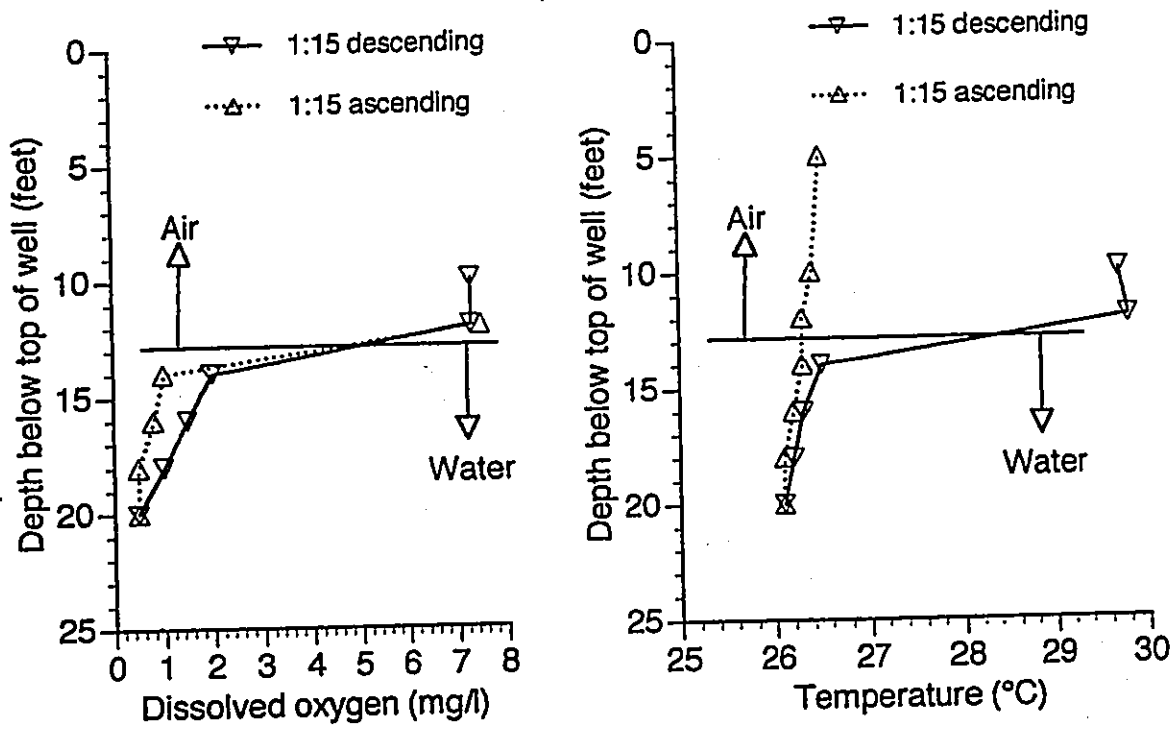

D. Hoover, DG: "O2, T profs 10/19/96"

MW-2: 10/24/96

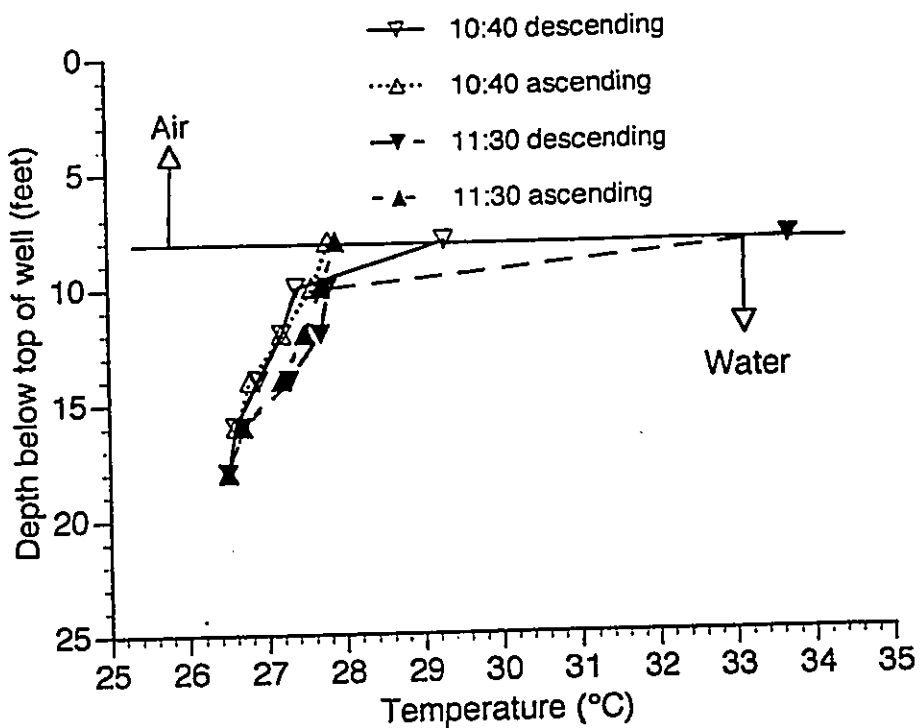
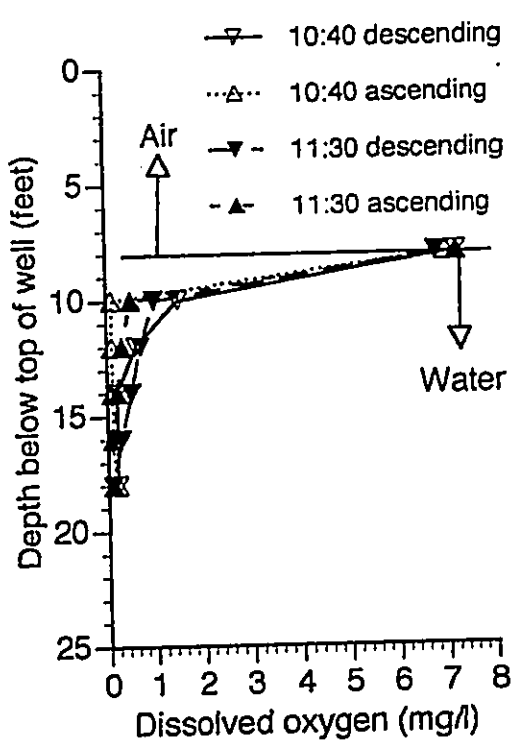

MW-4: 10/24/96

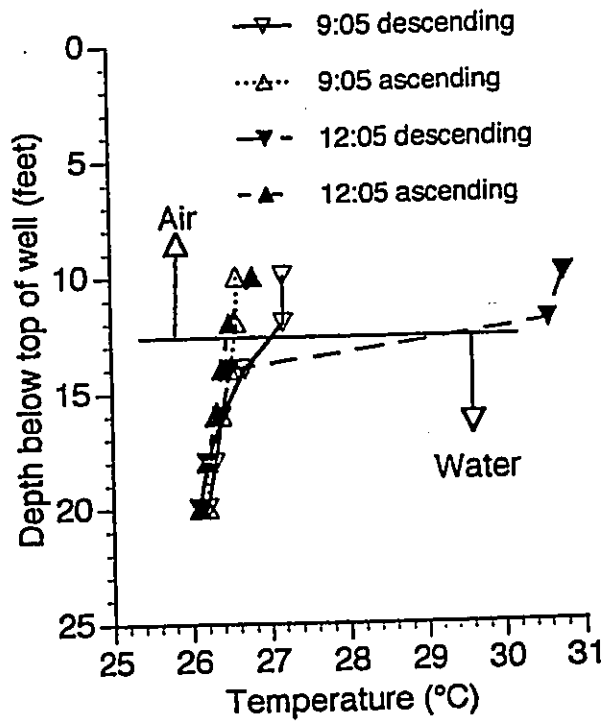
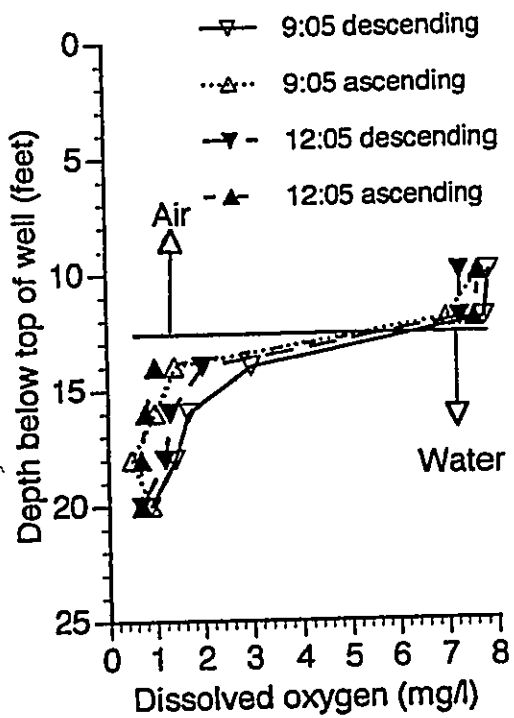

D. Hoover, DG: "O2, T profs 10/24/96"

MW-1: 11/2/96

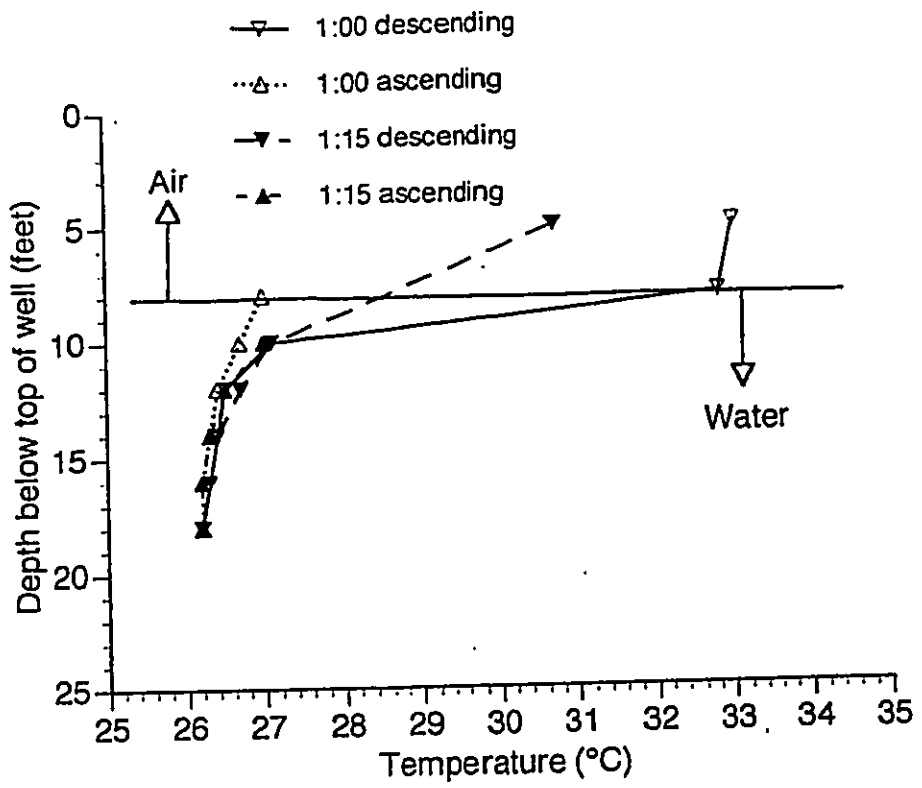
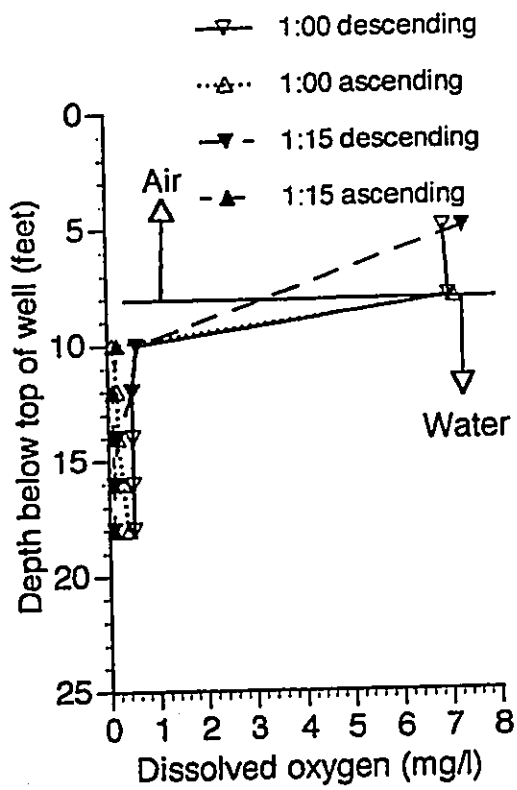

MW-3: 11/2/96

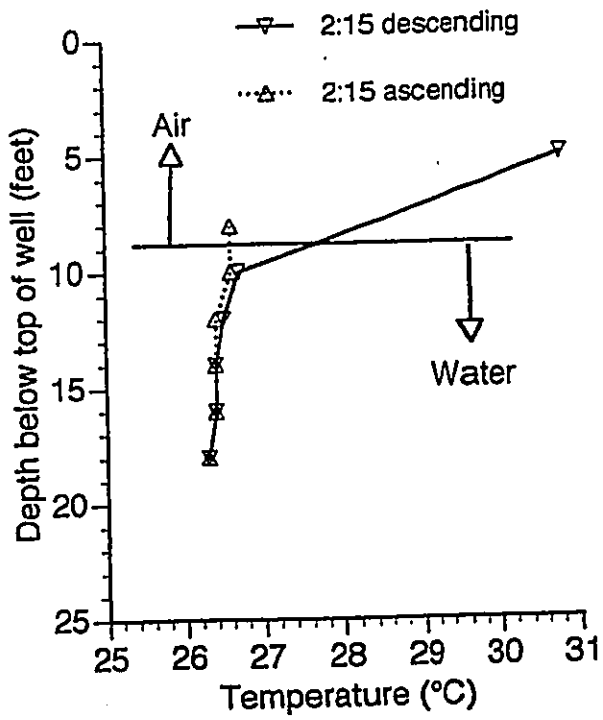
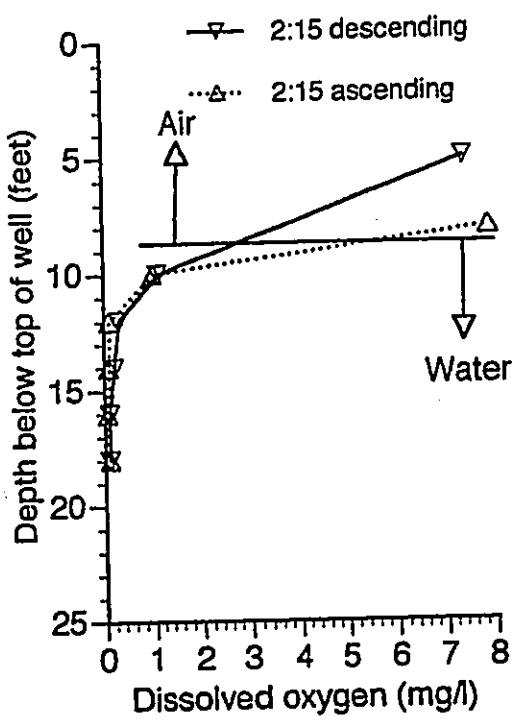

D. Hoover, DG: "O2, T profs 11/2/96"

MW-2: 11/2/96

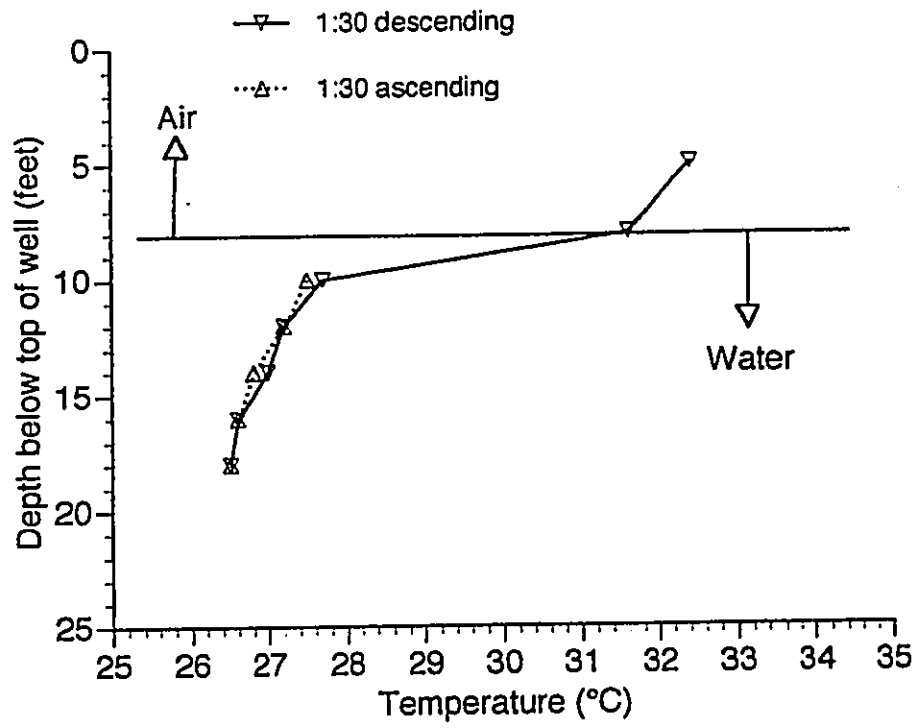
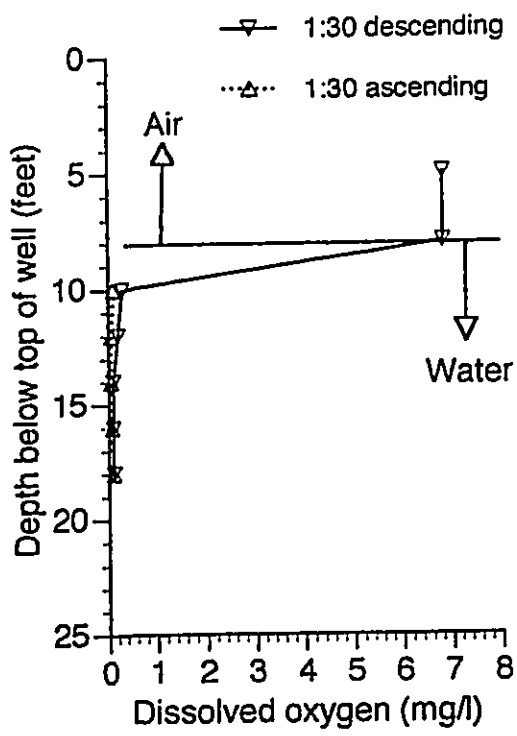

MW-4: 11/2/96

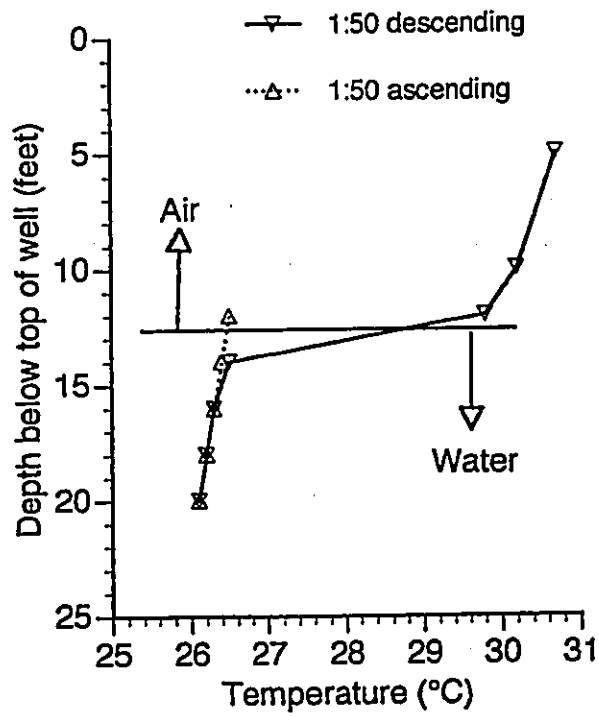
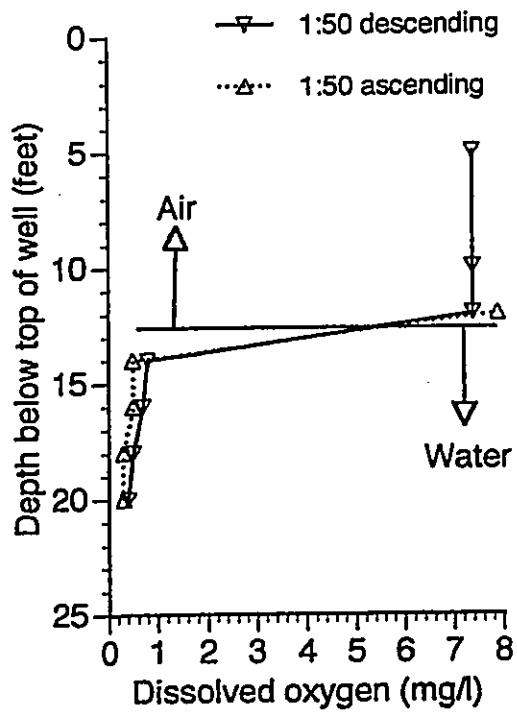

D. Hoover, DG: "O2, T profs 11/2/96"

MW-1: 11/6/96

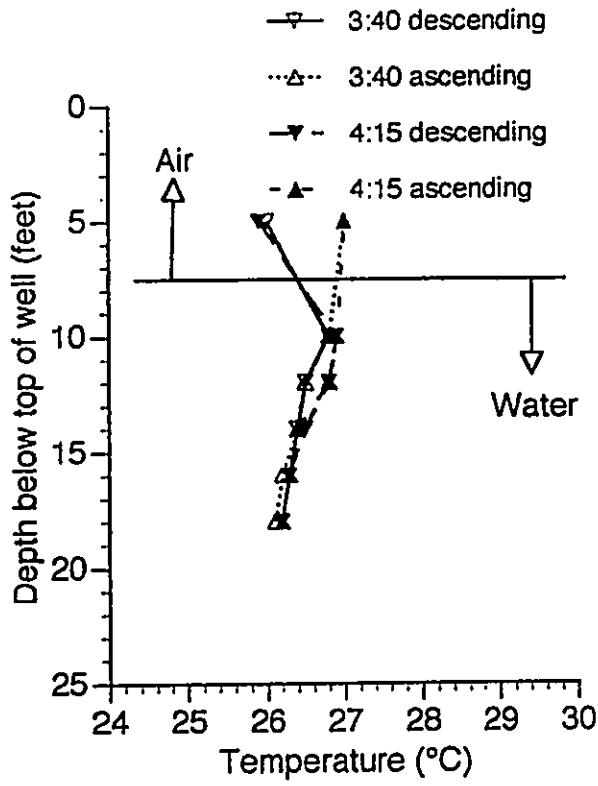
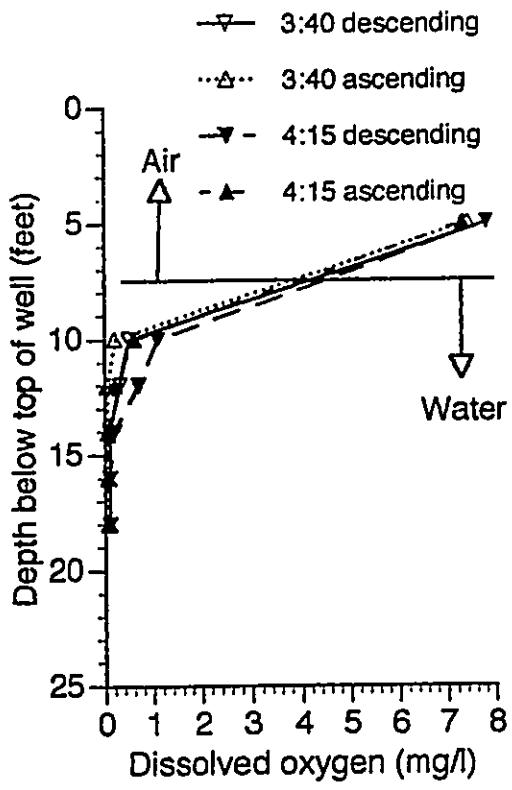

MW-3: 11/6/96

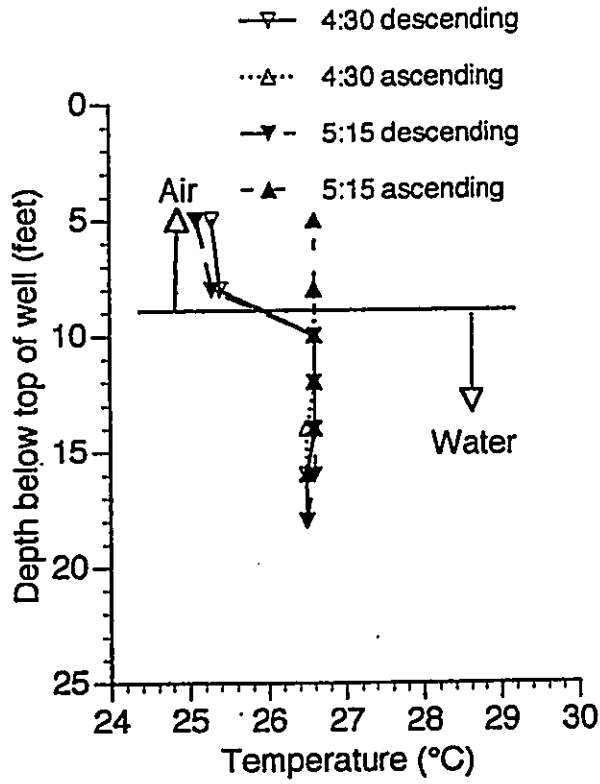
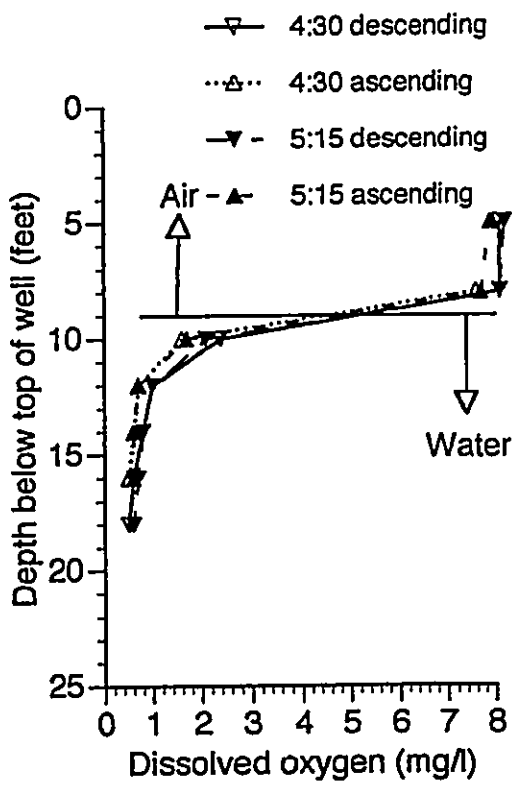

D. Hoover, DG: "O2, T profs 11/6/96"

MW-2: 11/6/96

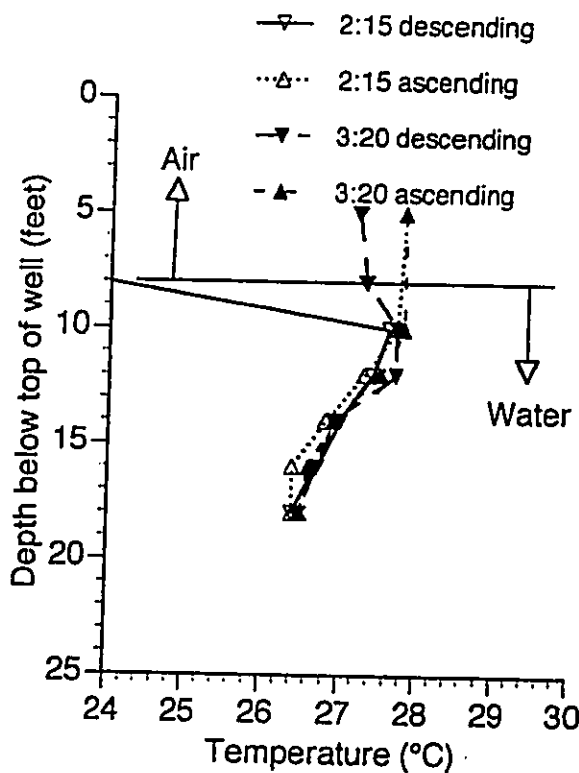
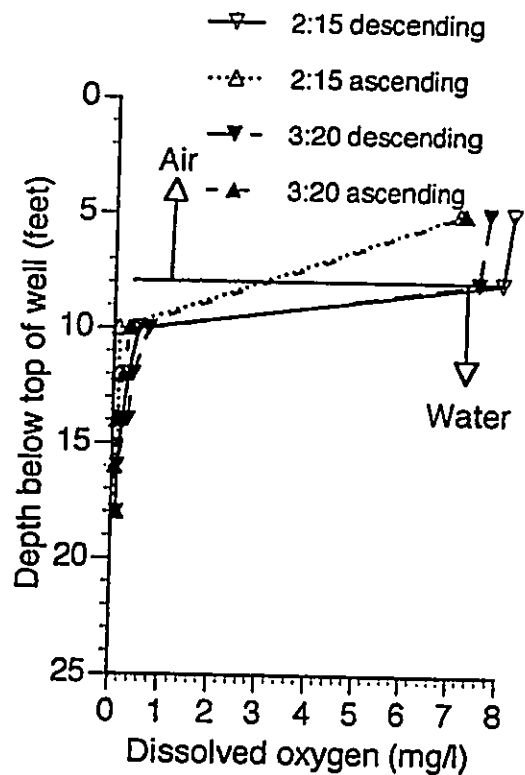

MW-4: 11/6/96

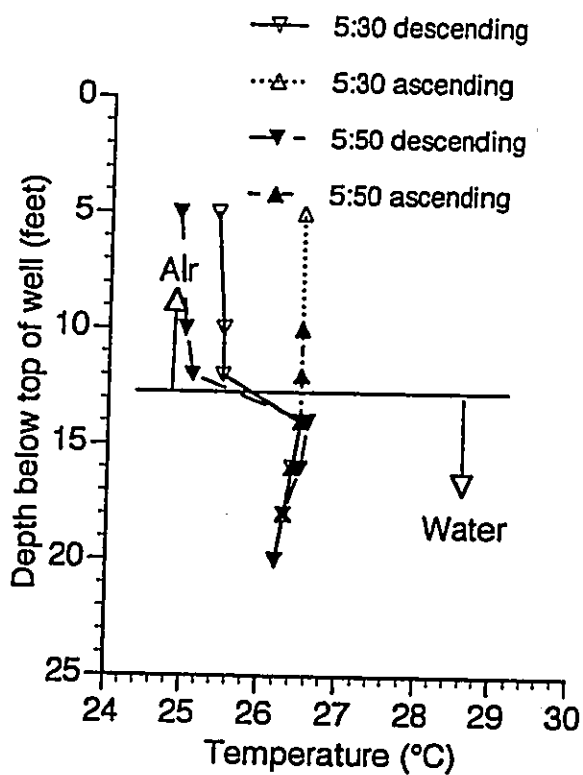
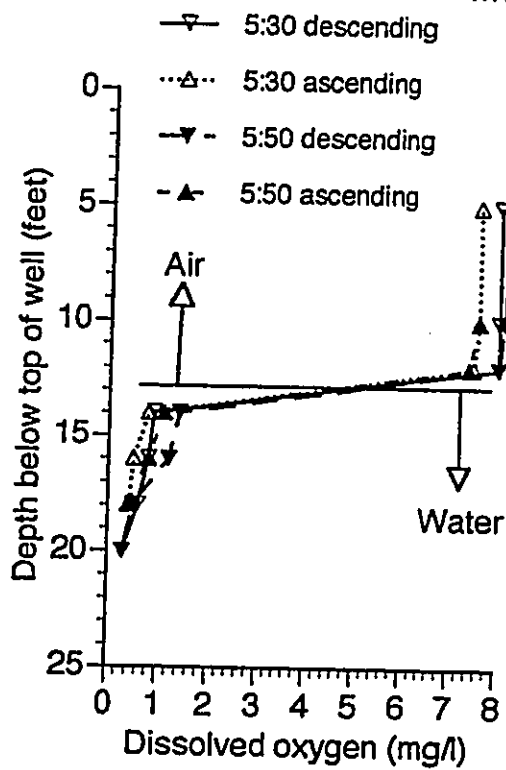

D. Hoover, DG: "O2, T profs 11/6/96"

MW-1: 11/21/96

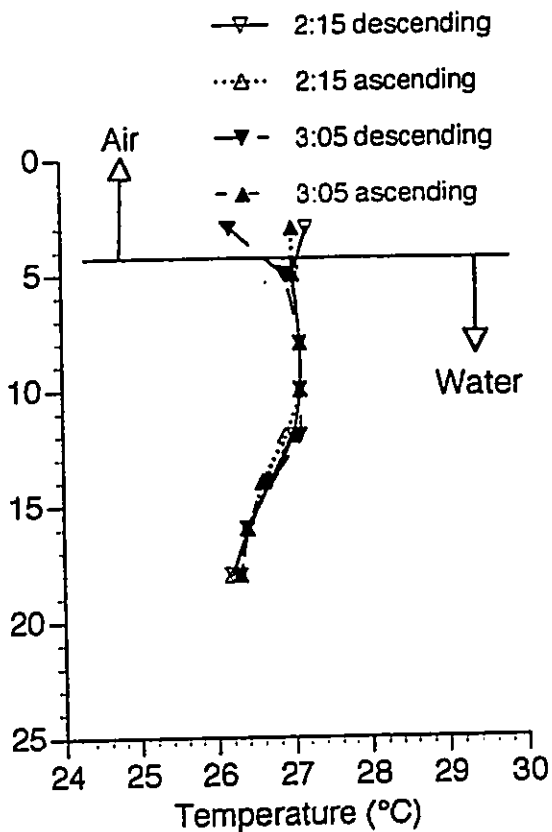
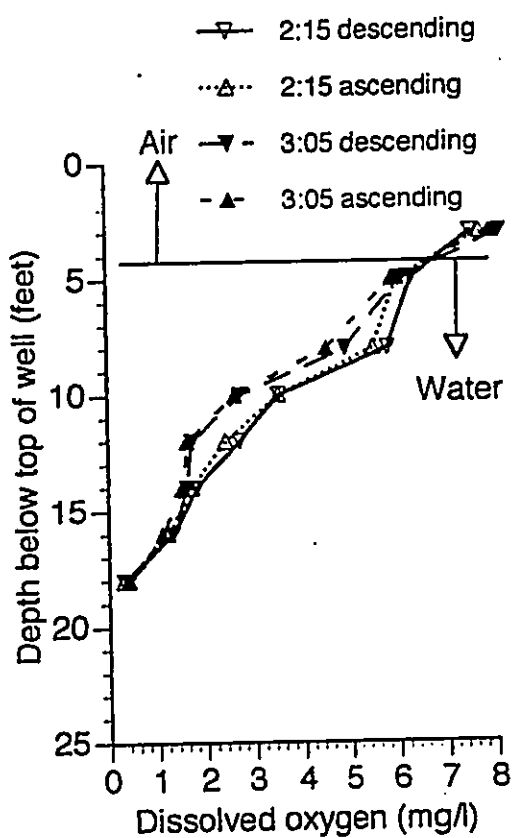

MW-3: 11/21/96

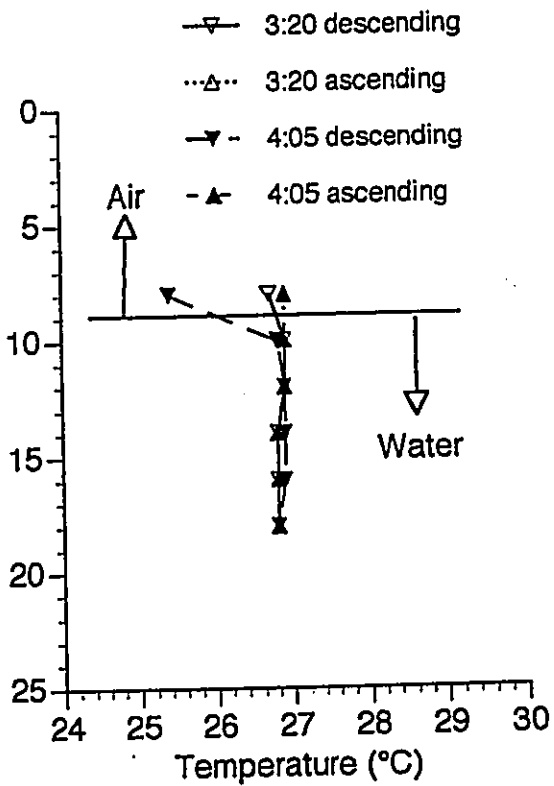
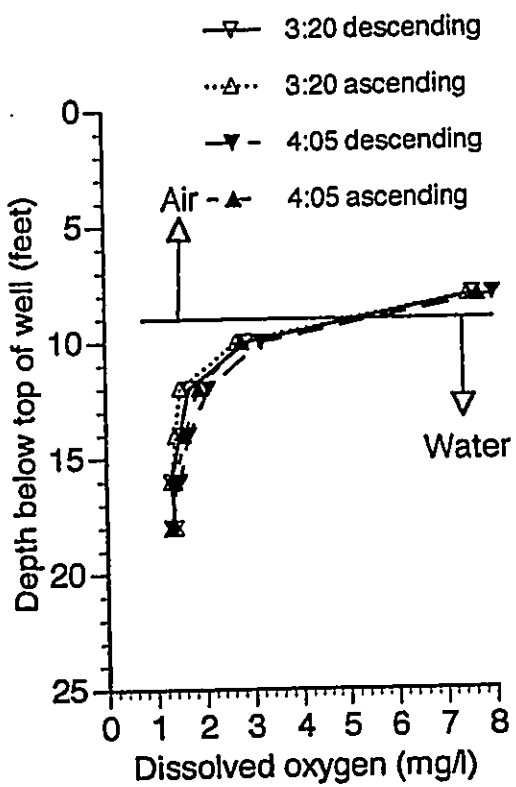

D. Hoover, DG: "O2, T profs 11/21/96"

MW-2: 11/21/96

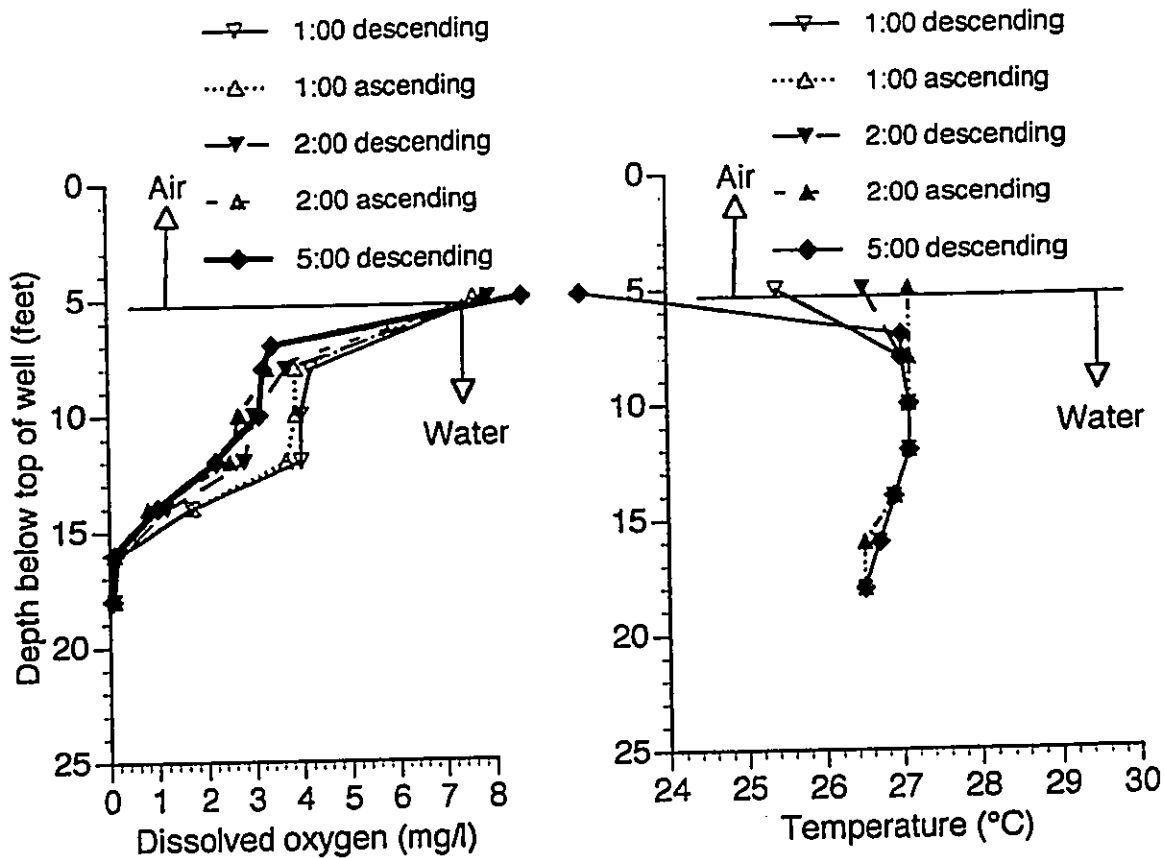

MW-4: 11/21/96

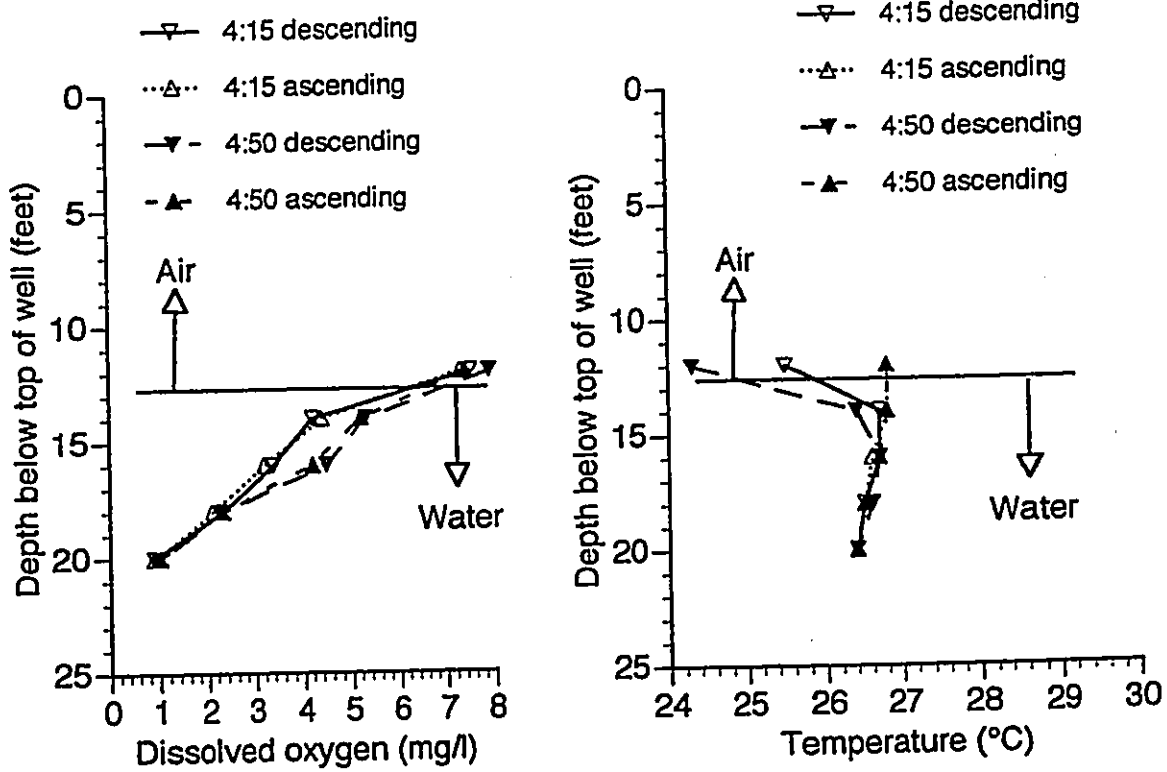

D. Hoover, DG: "O2, T profs 11/21/96"

MW-1: 11/24/96

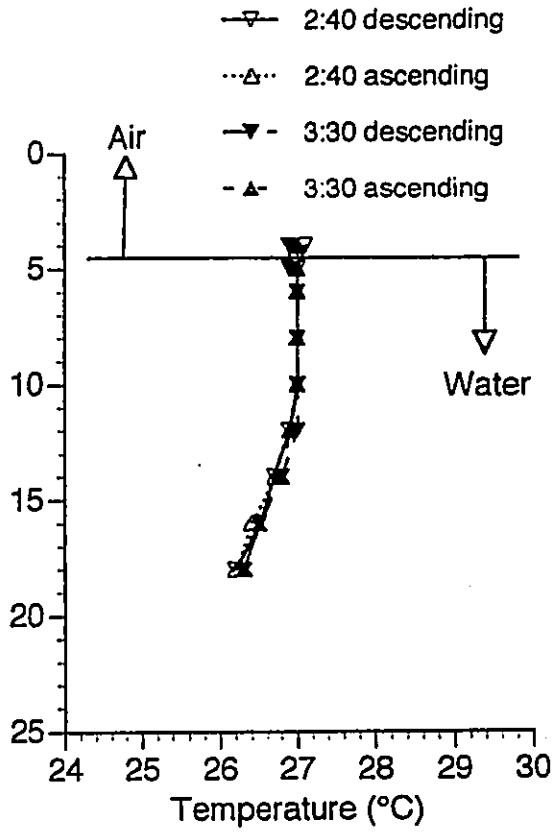
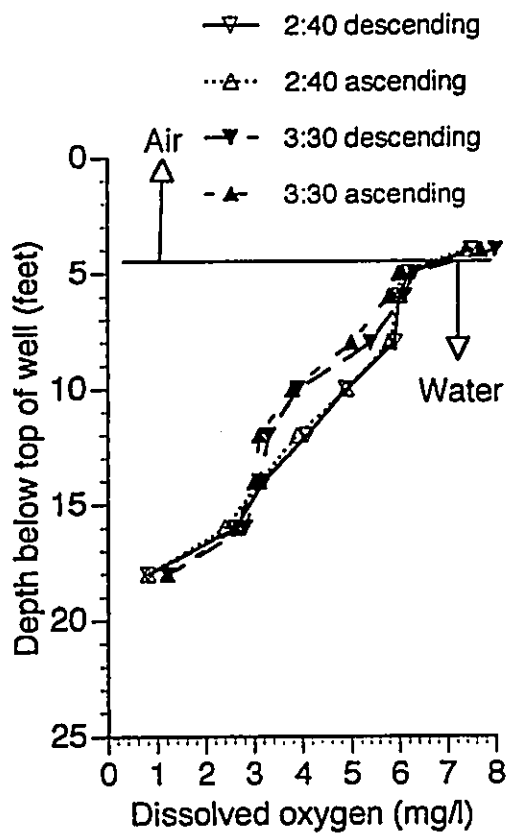

MW-3: 11/24/96

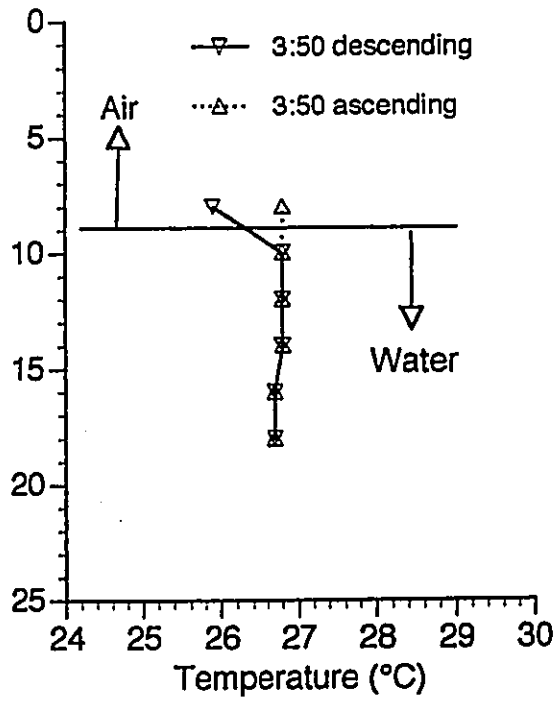
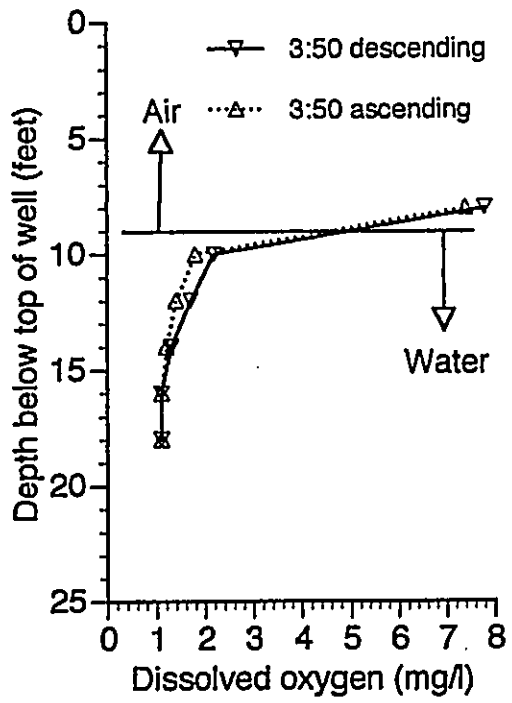

D. Hoover, DG: "O2, T profs 11/24/96"

MW-2: 11/24/96

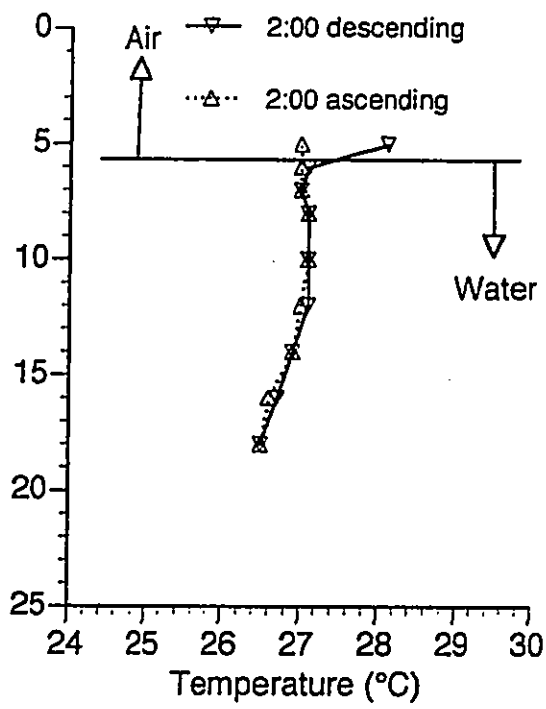
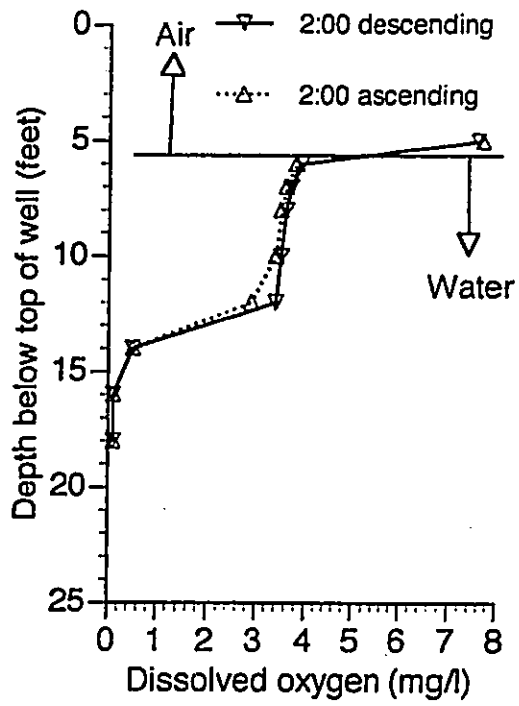

MW-4: 11/24/96

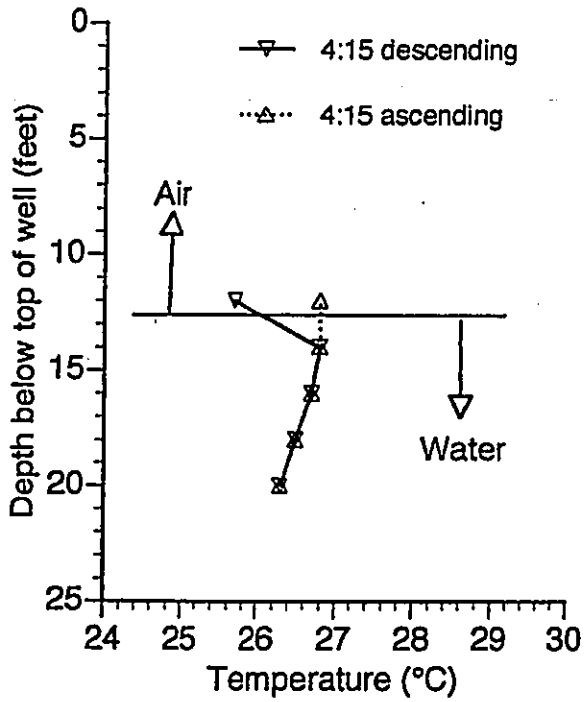
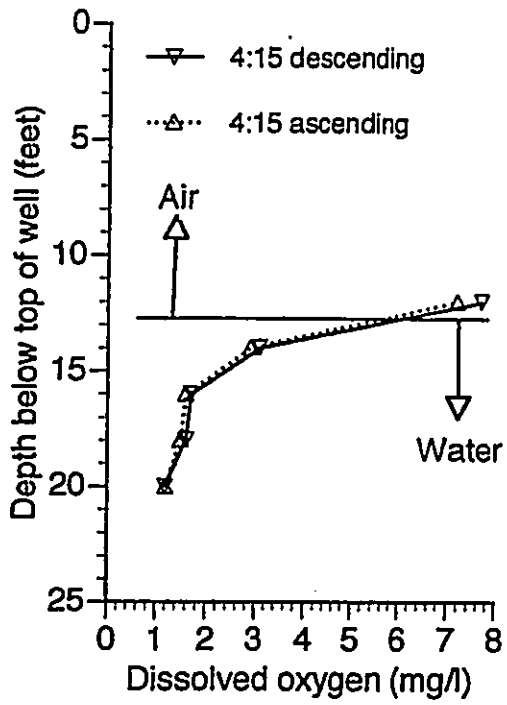

D. Hoover, DG: "O2, T profs 11/24/96"

MW-1: 11/29/96

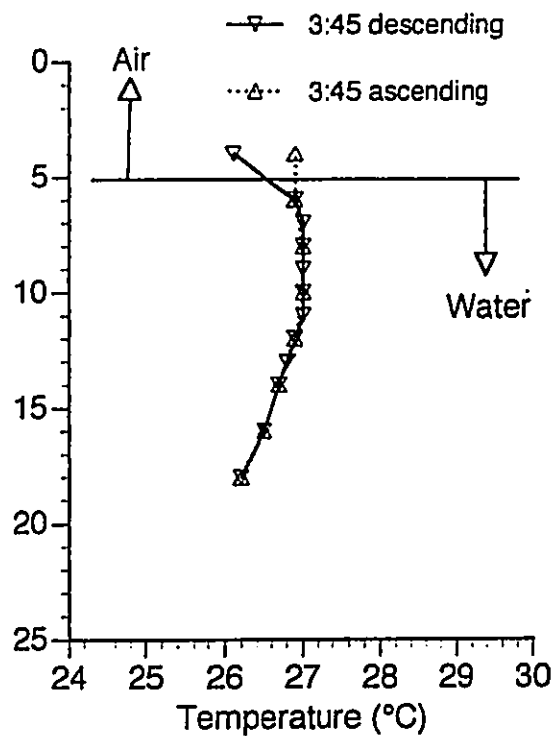
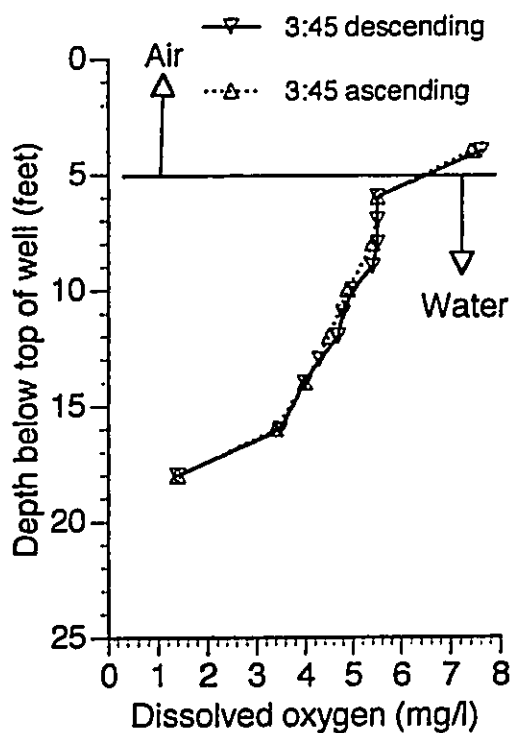

MW-3: 11/29/96

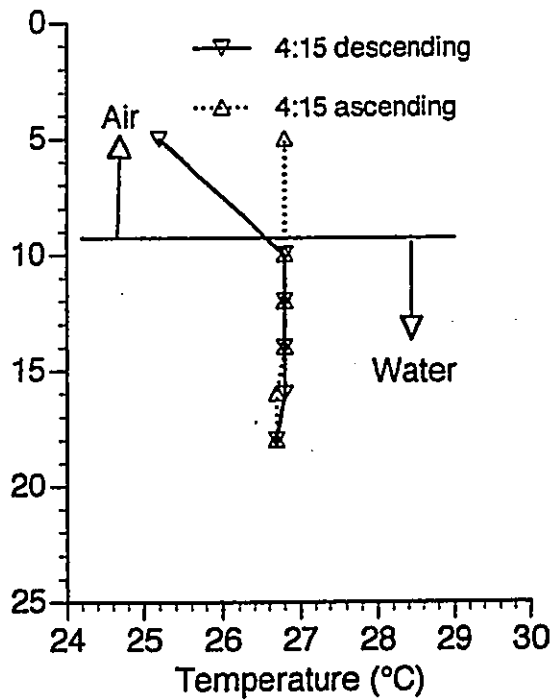
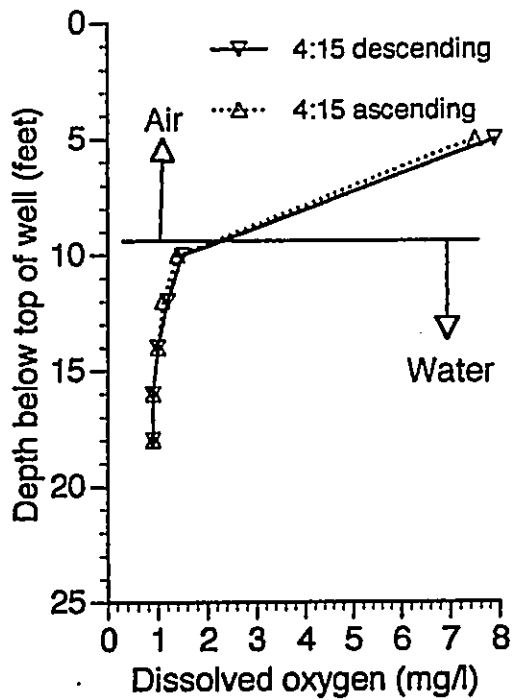

D. Hoover, DG: "O2, T profs 11/29/96"

MW-2: 11/29/96

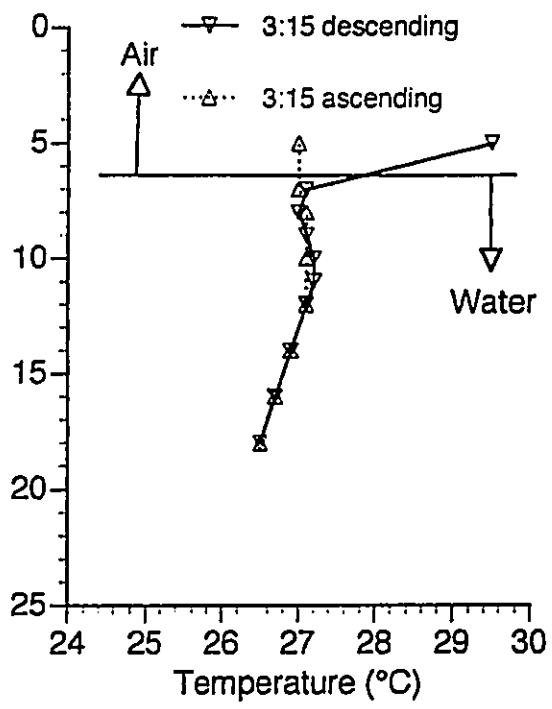
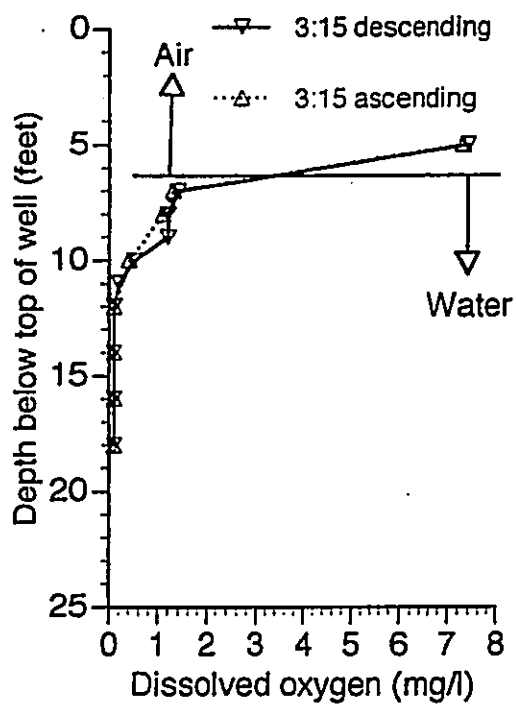

MW-4: 11/29/96

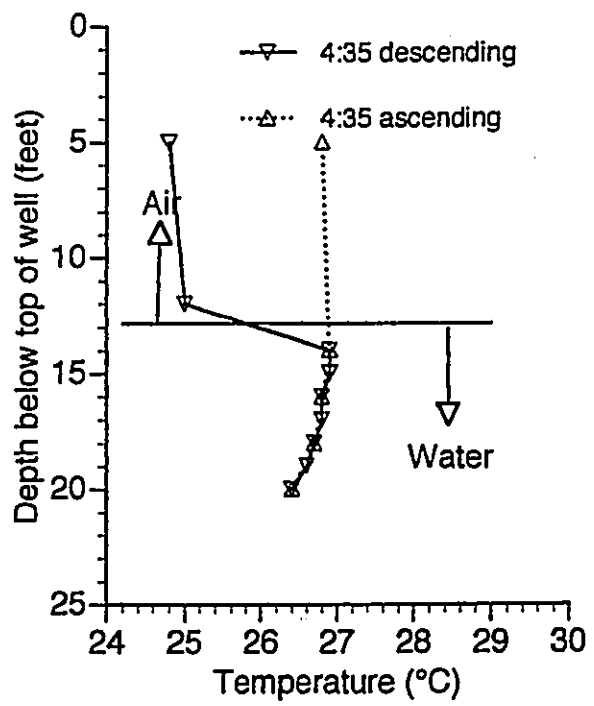
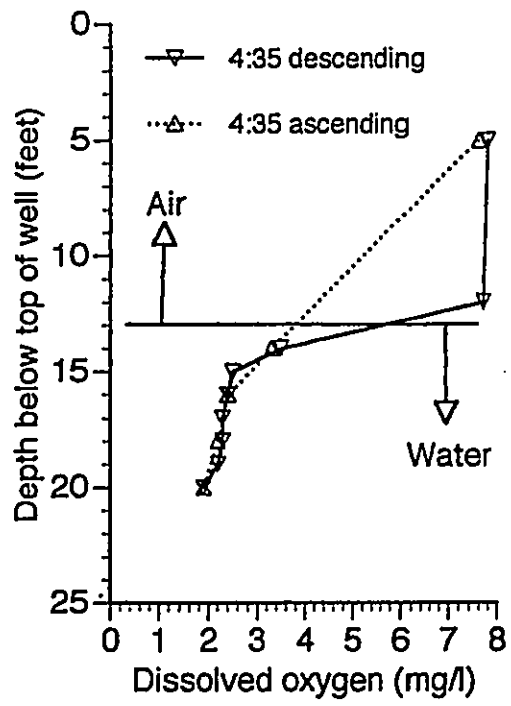

D. Hoover, DG: "O2, T profs 11/29/96"

MW-1: 12/6/96

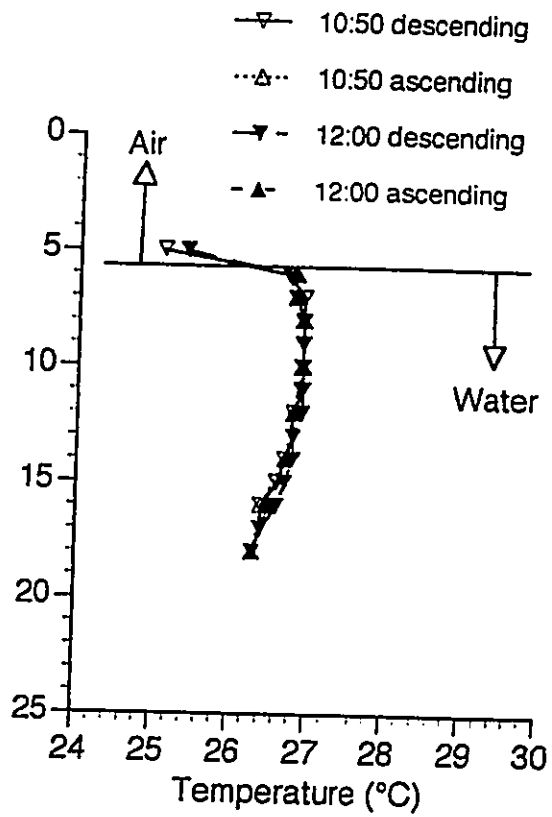
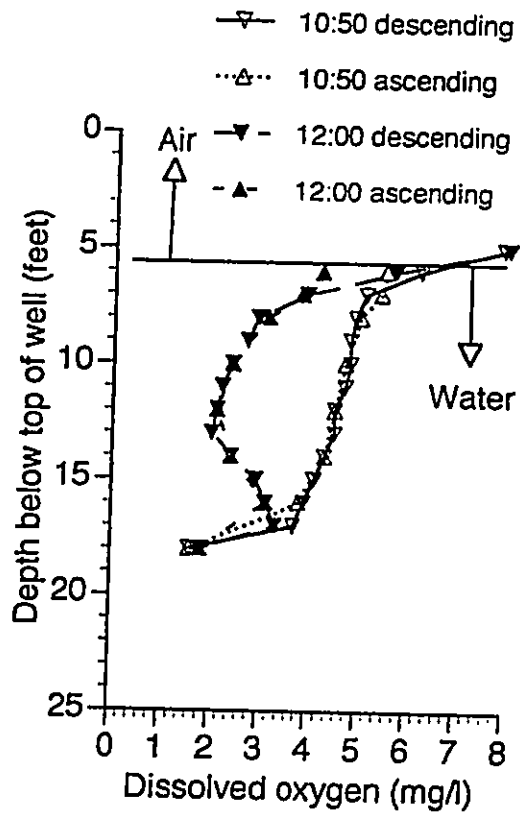

MW-3: 12/6/96

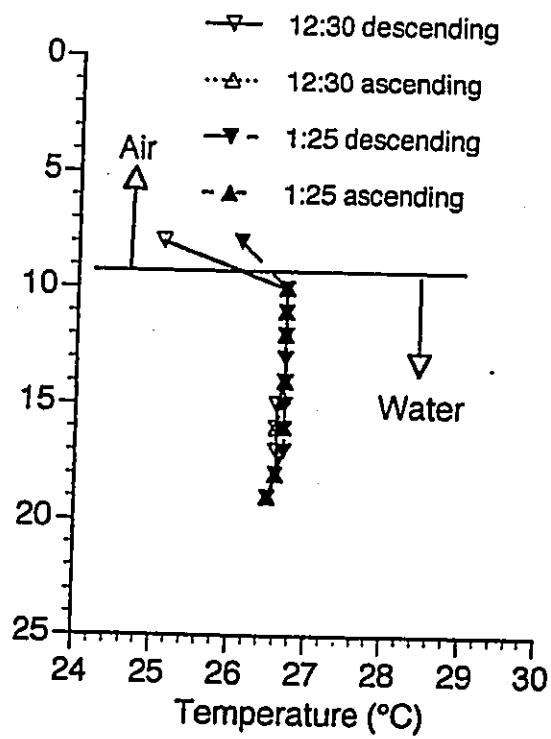
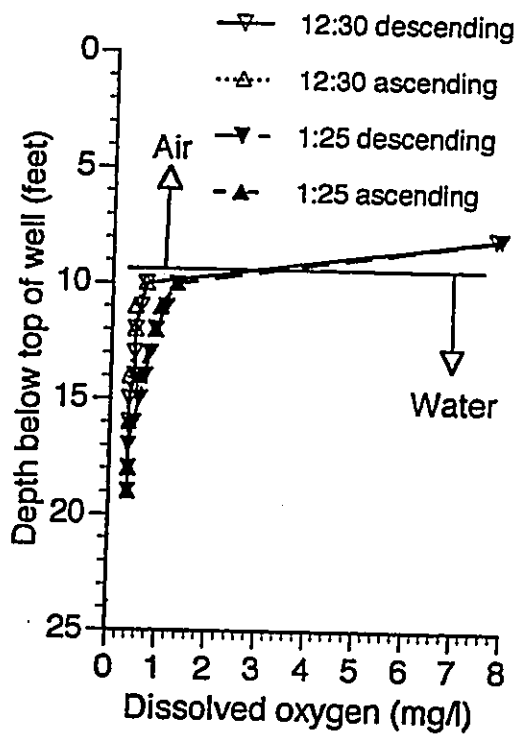

D. Hoover, DG: "O2, T profs 12/6/96"

MW-2: 12/6/96

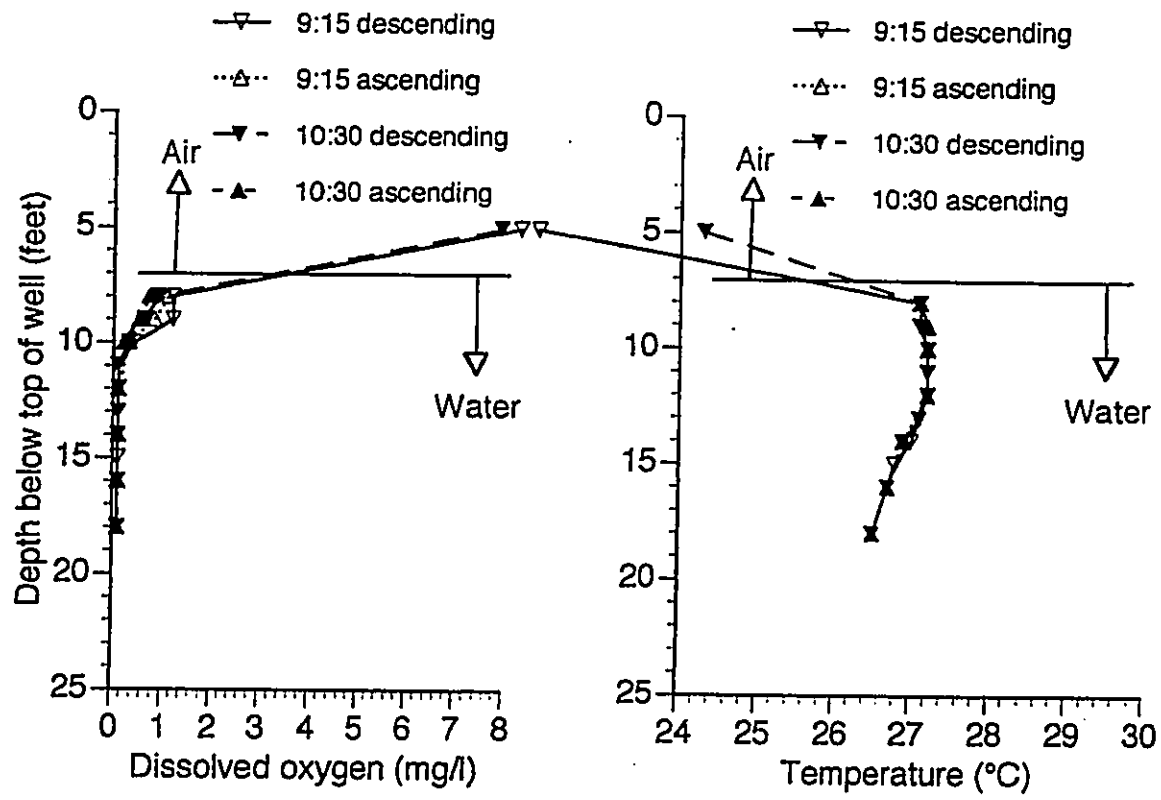

MW-4: 12/6/96

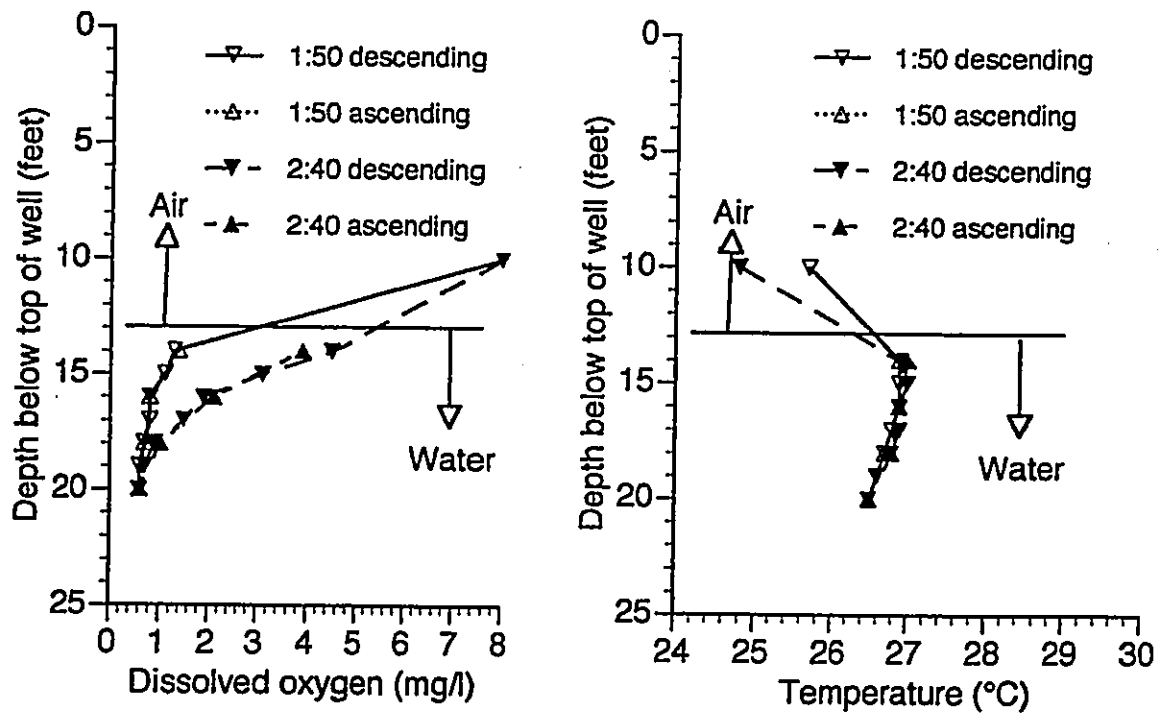

D. Hoover, DG: "O2, T profs 12/6/96"

MW-1: 12/14/96

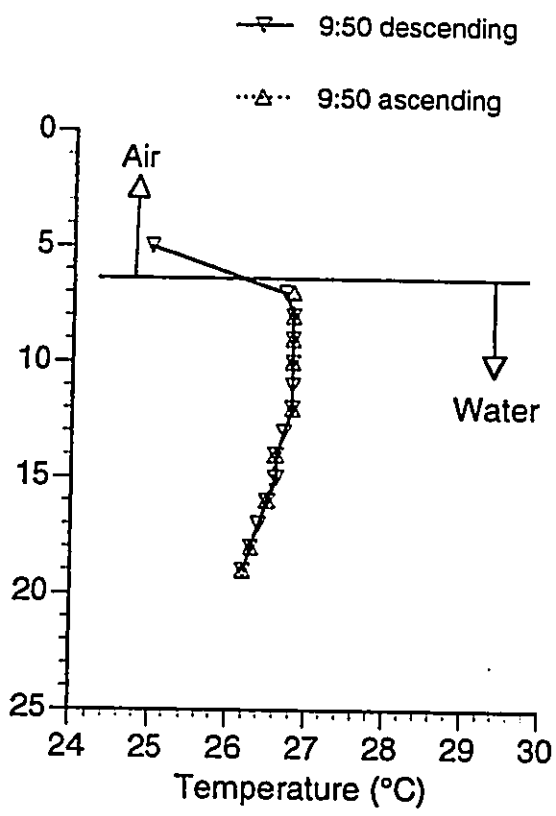
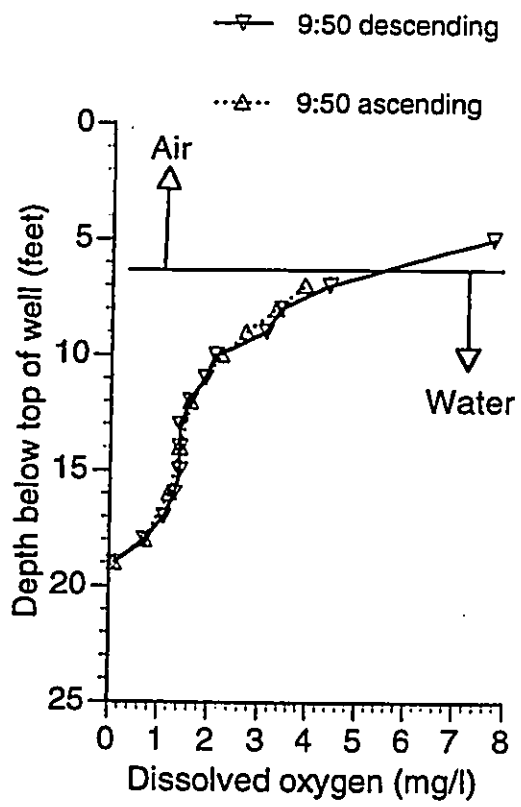

MW-3: 12/14/96

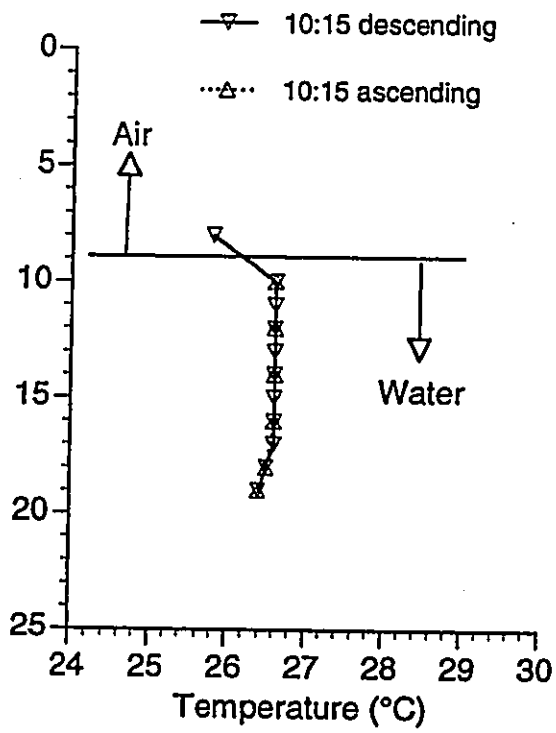
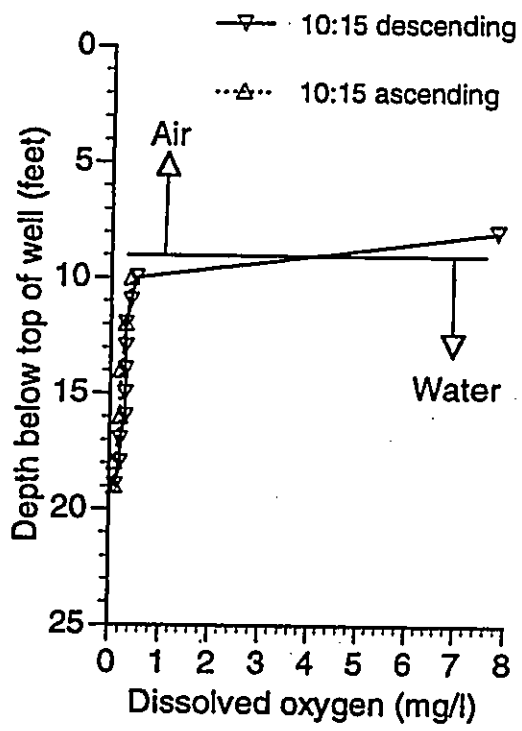

D. Hoover, DG: "O2, T profs 12/14/96"

MW-2: 12/14/96

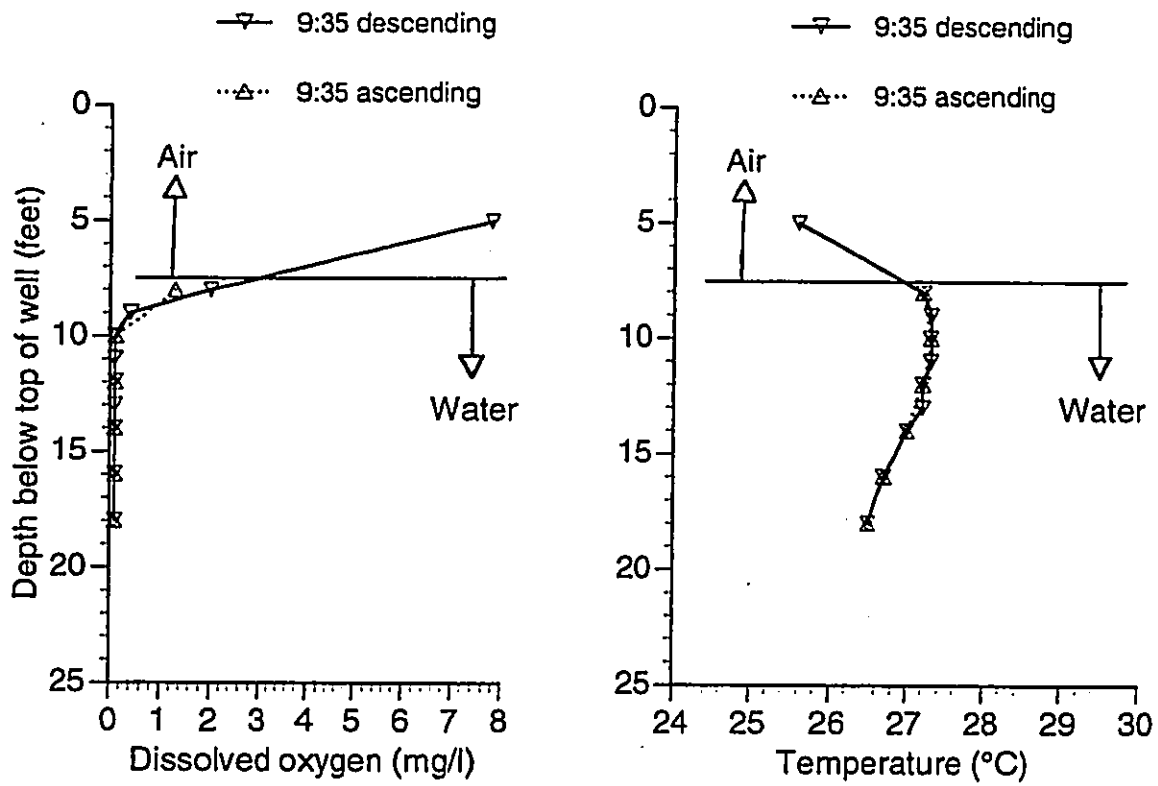

MW-4: 12/14/96

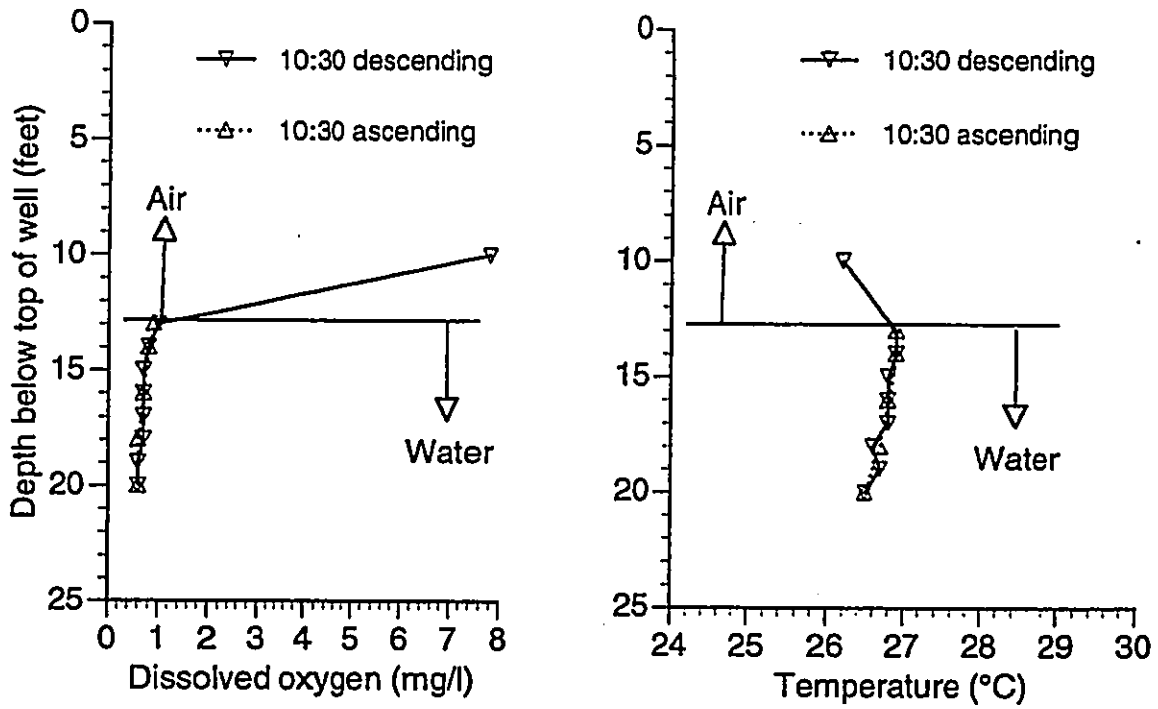

D. Hoover, DG: "O2, T profs 12/14/96"

MW-1: 12/18/96

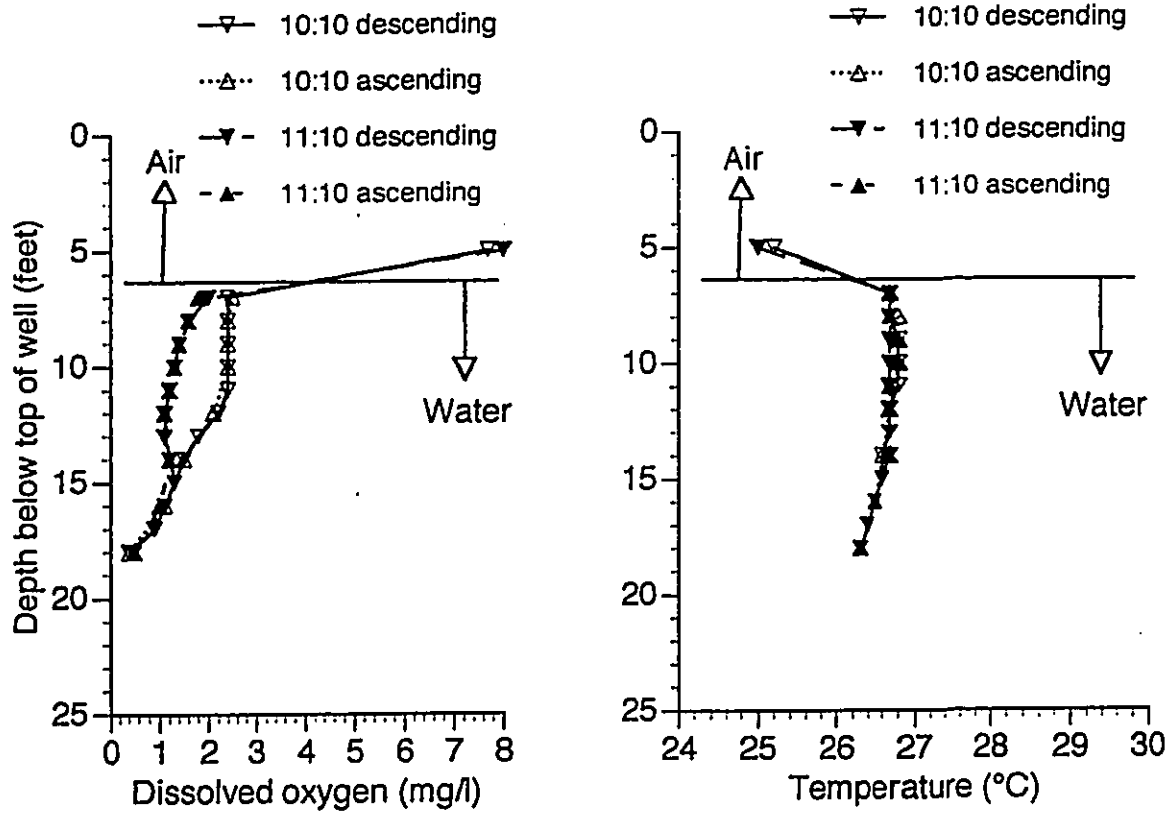

MW-3: 12/18/96

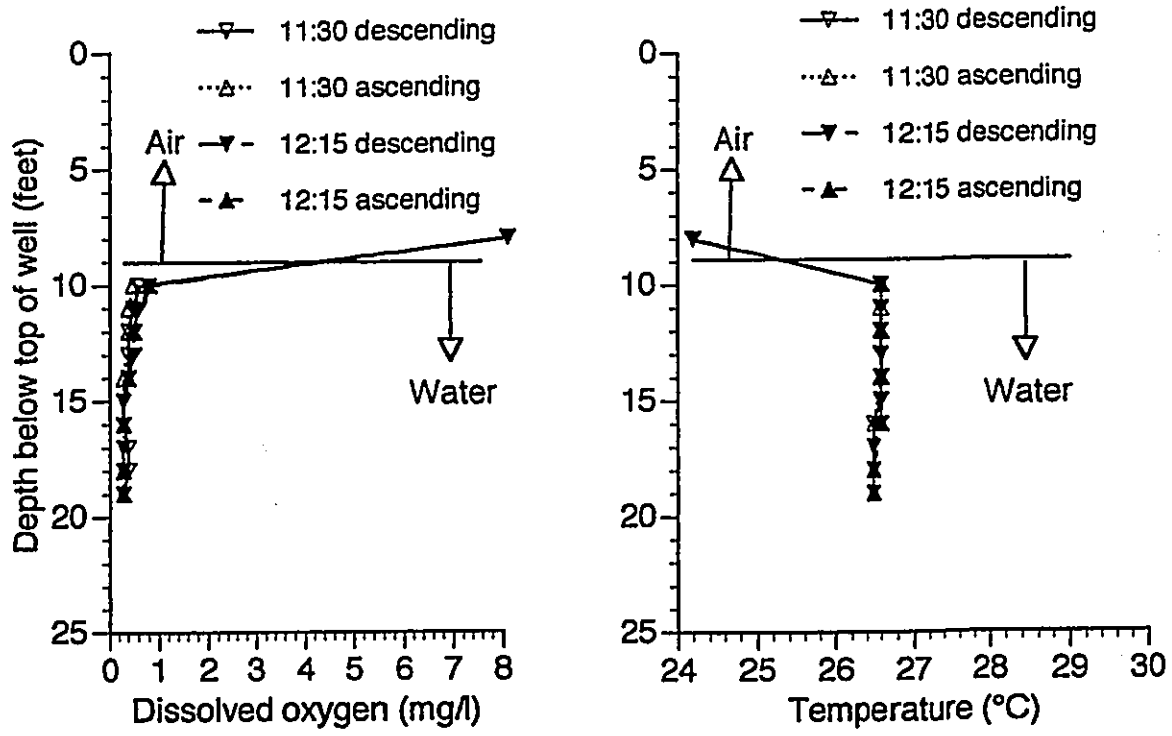

D. Hoover, DG: "O2, T profs 12/18/96"

MW-2: 12/18/96

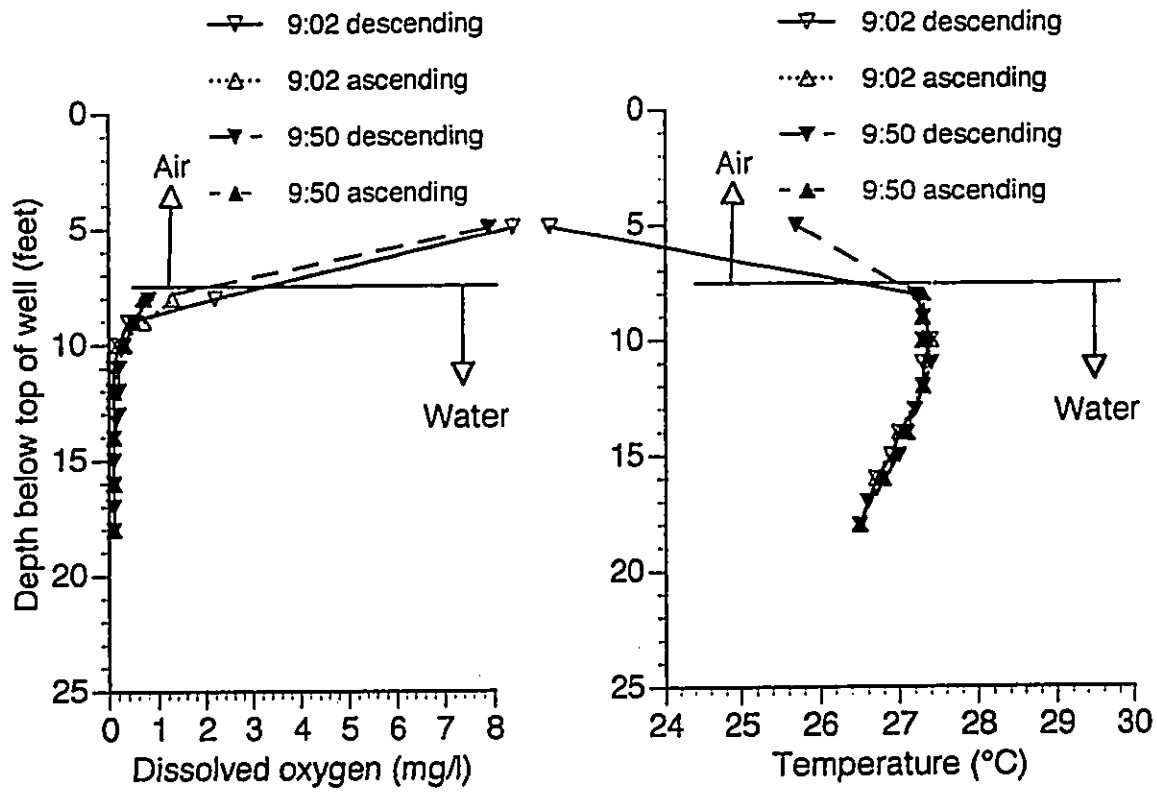

MW-4: 12/18/96

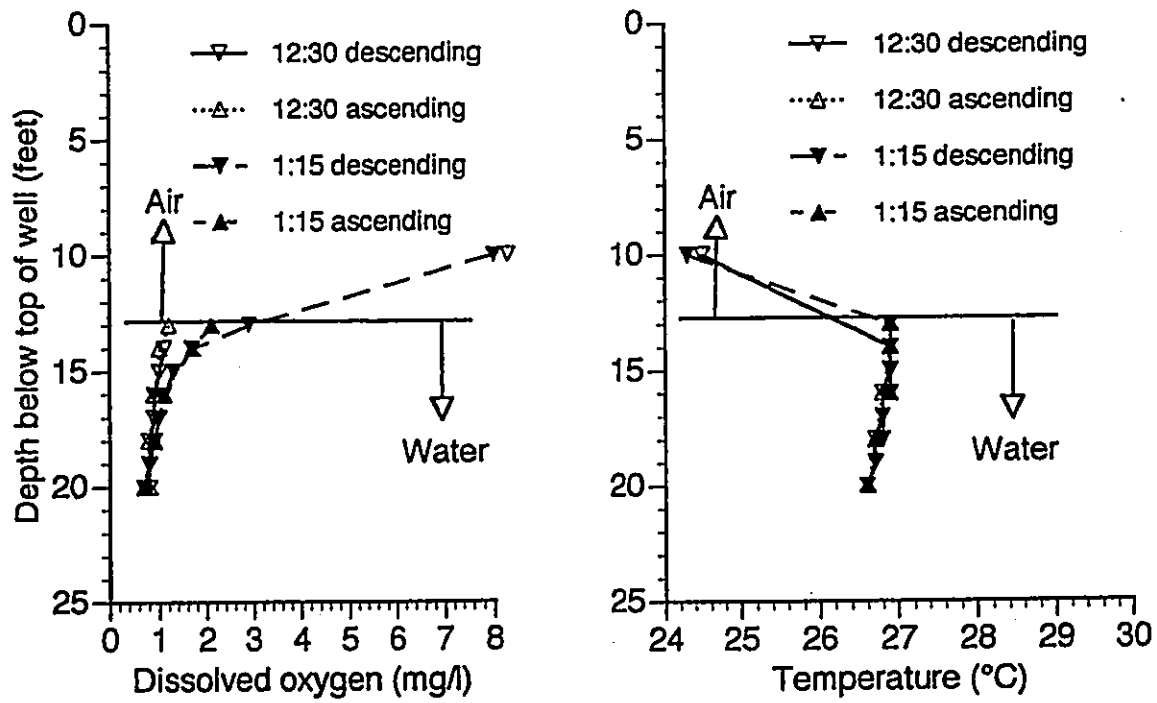

D. Hoover, DG: "O2, T profs 12/18/96"

MW-1: 12/28/96

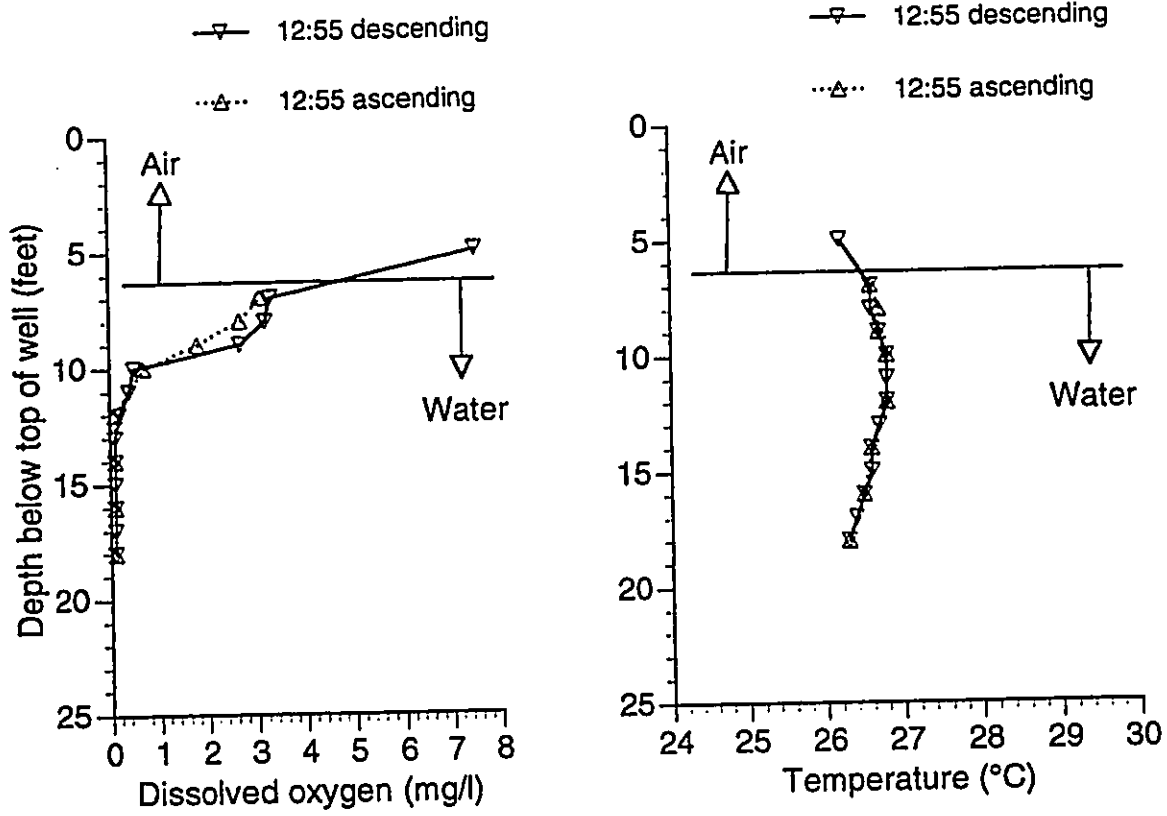

MW-3: 12/28/96

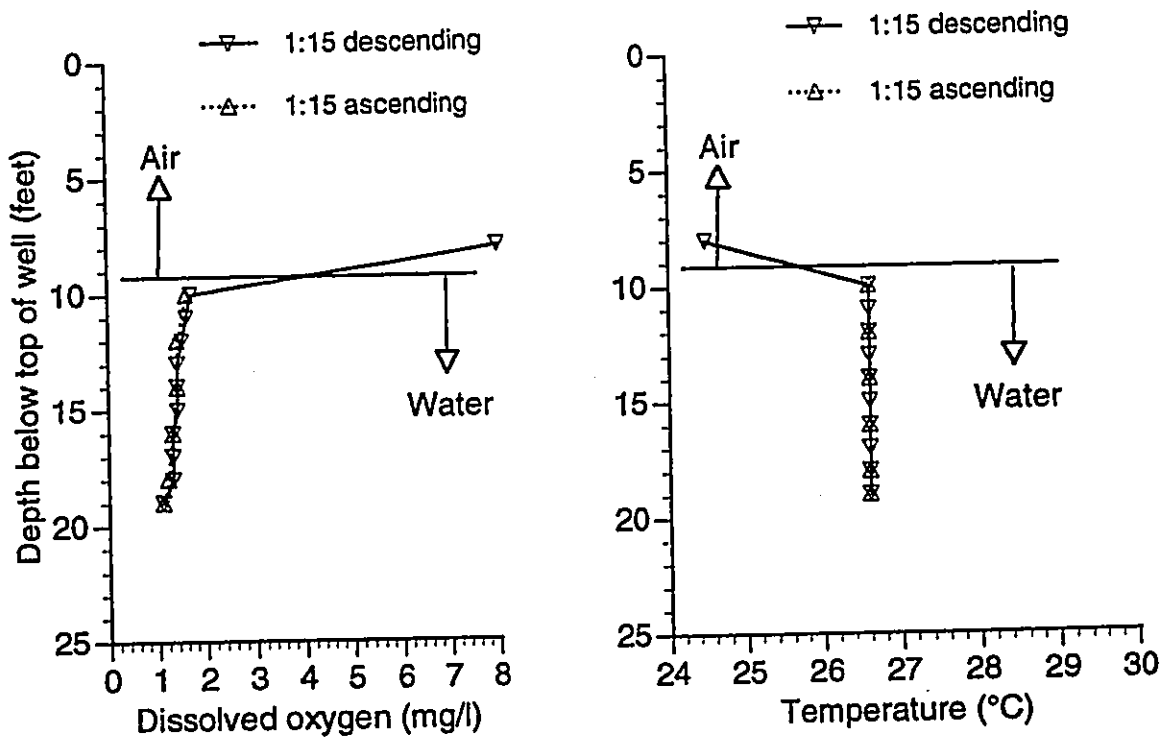

D. Hoover, DG: "O2, T profs 12/28/96"

MW-2: 12/28/96

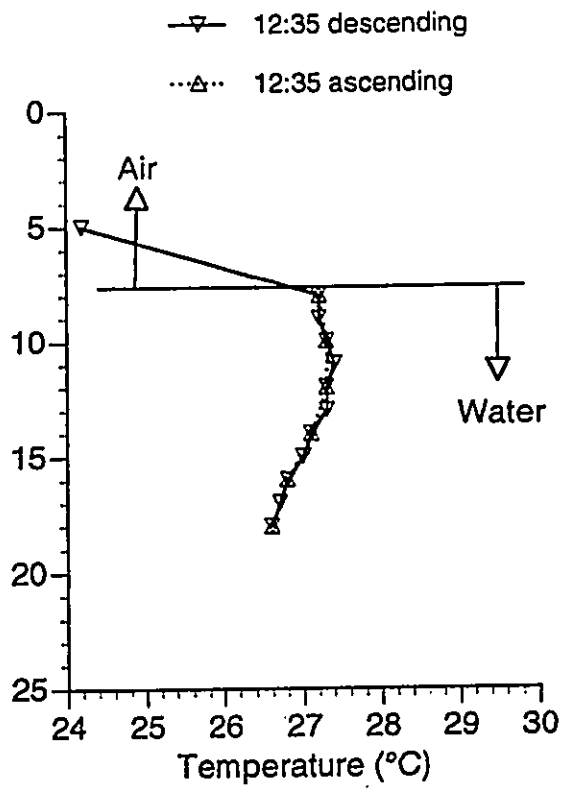
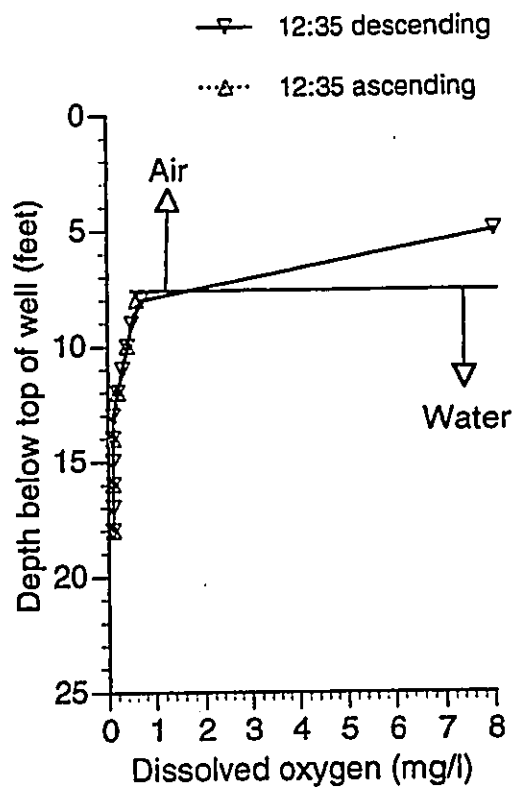

MW-4: 12/28/96

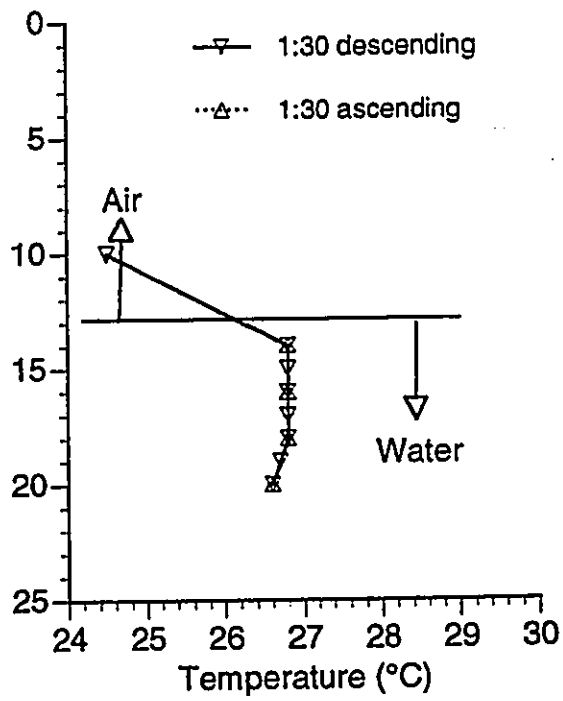
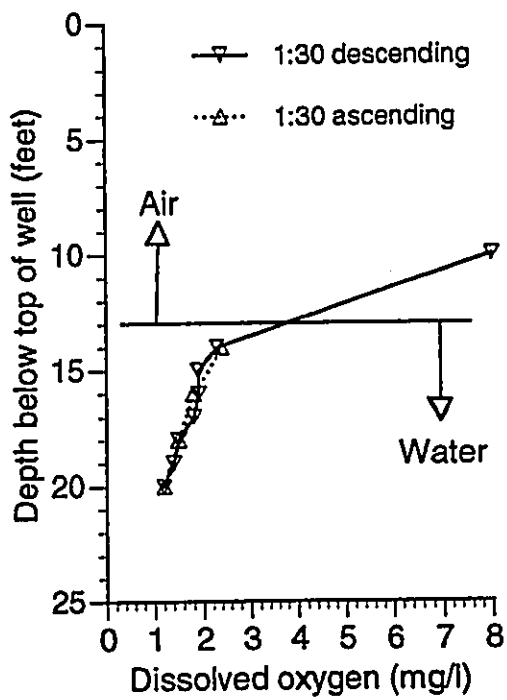

D. Hoover, DG: "O2, T profs 12/28/96"

MW-1: 1/2/97

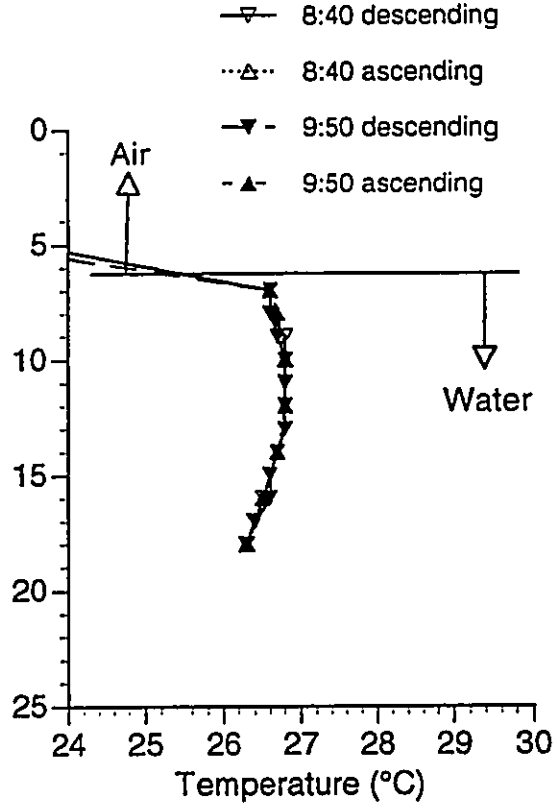
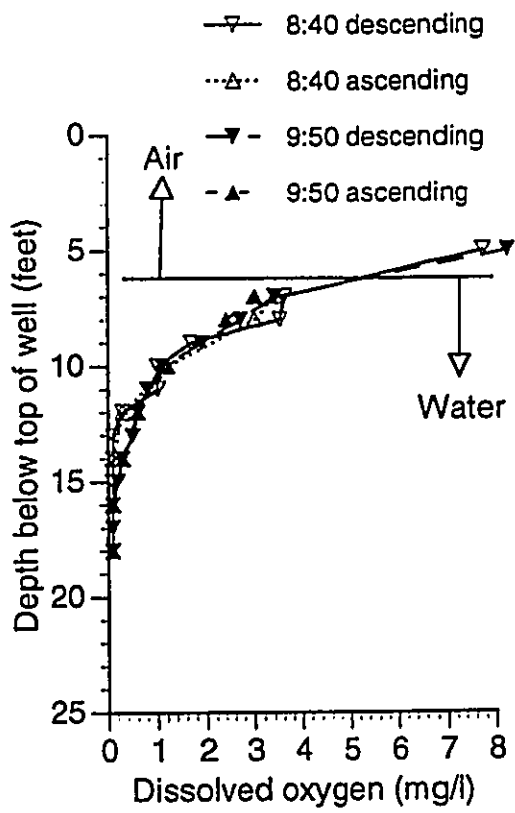

MW-3: 1/2/97

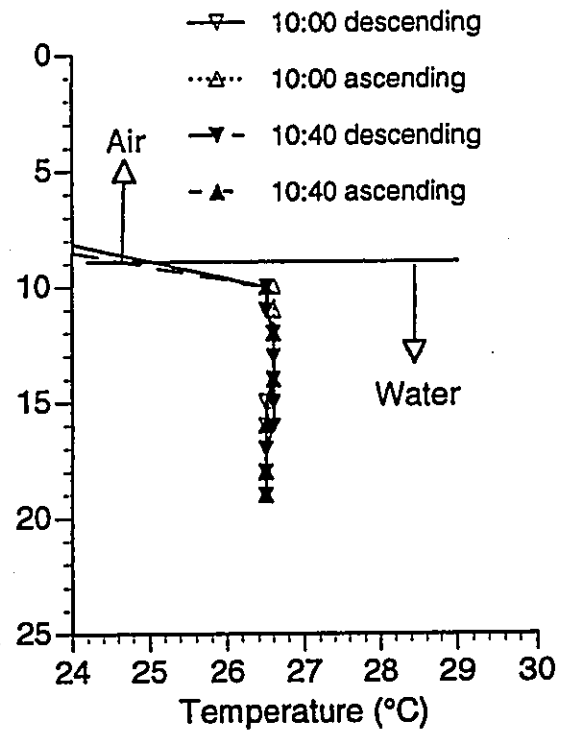
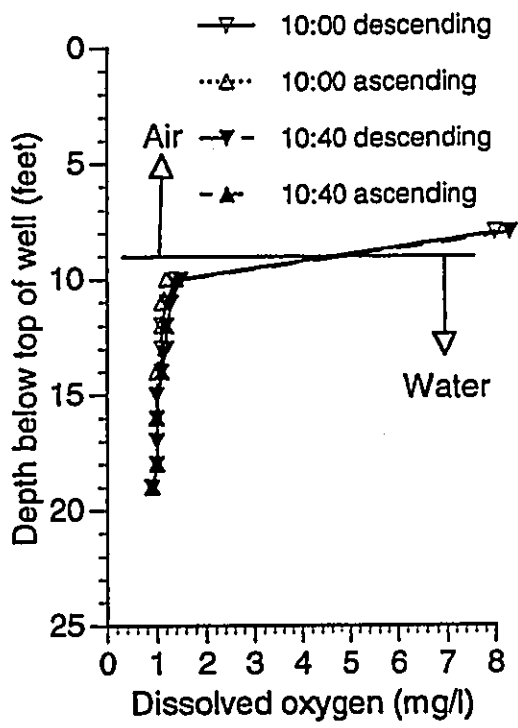

D. Hoover, DG: "O2, T profs 1/2/97"

MW-2: 1/2/97

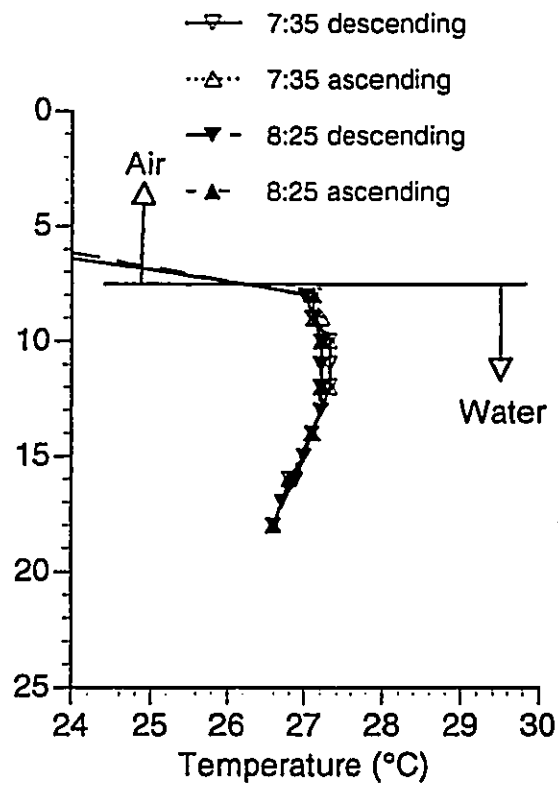
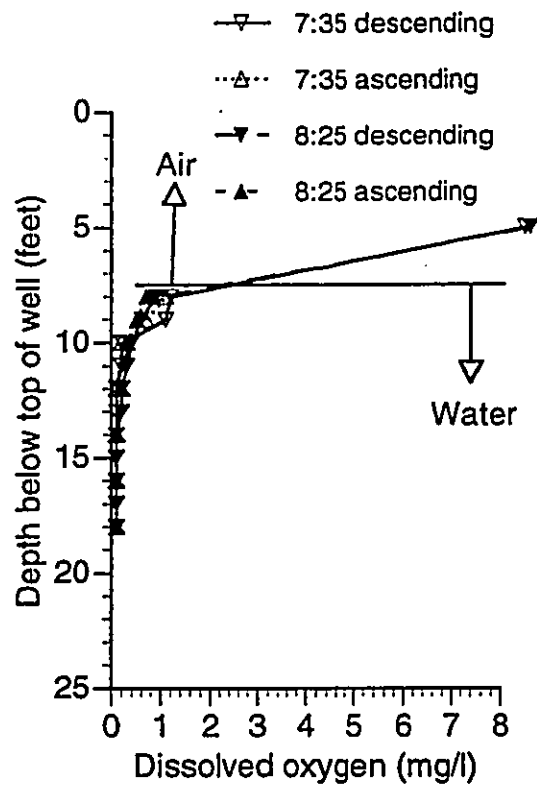

MW-4: 1/2/97

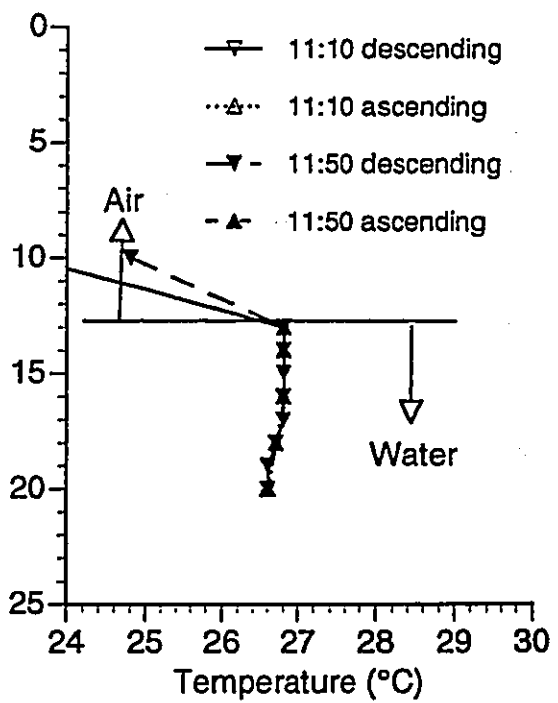
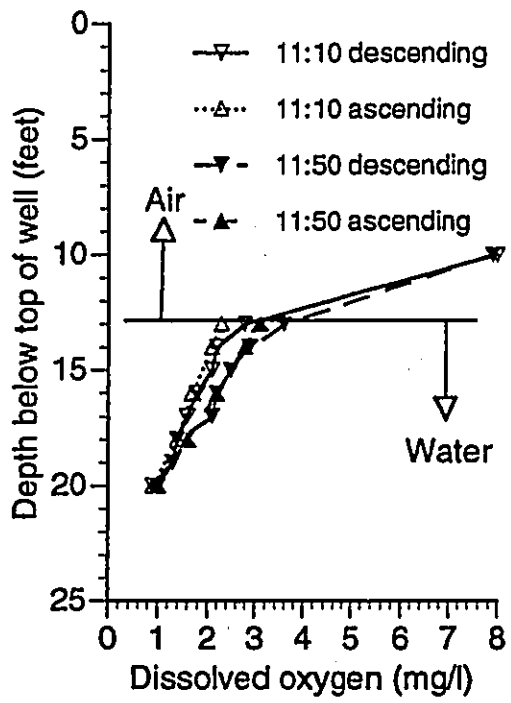

D. Hoover, DG: "O2, T profs 1/2/97"

MW-1: 1/1/97

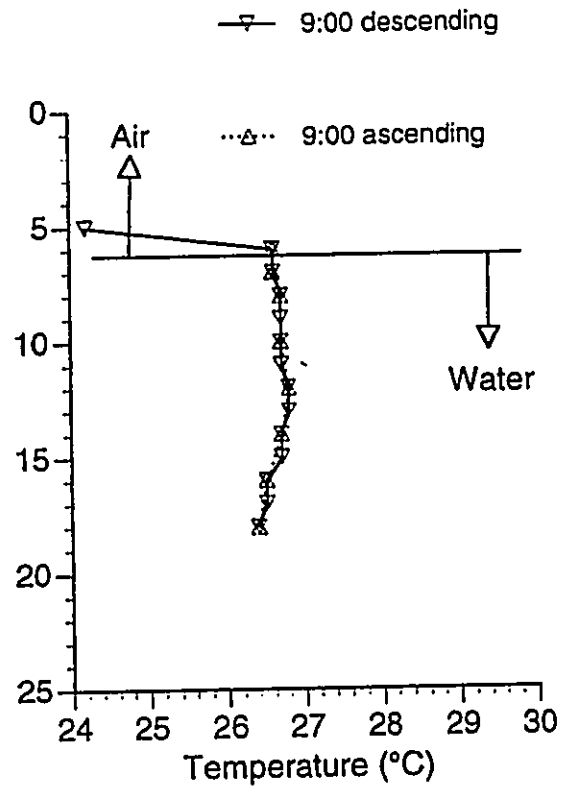
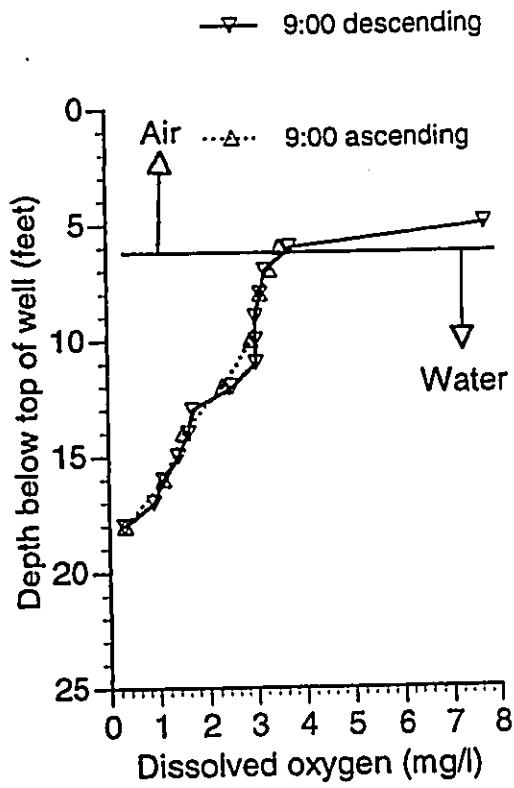

MW-3: 1/11/97

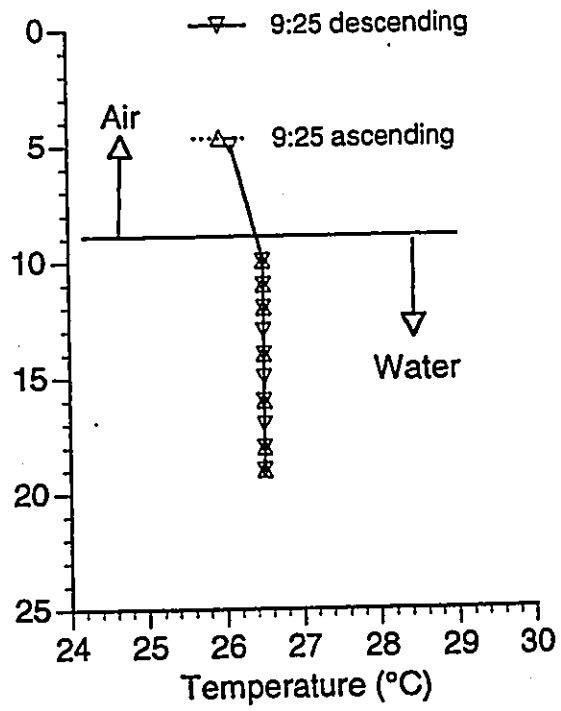
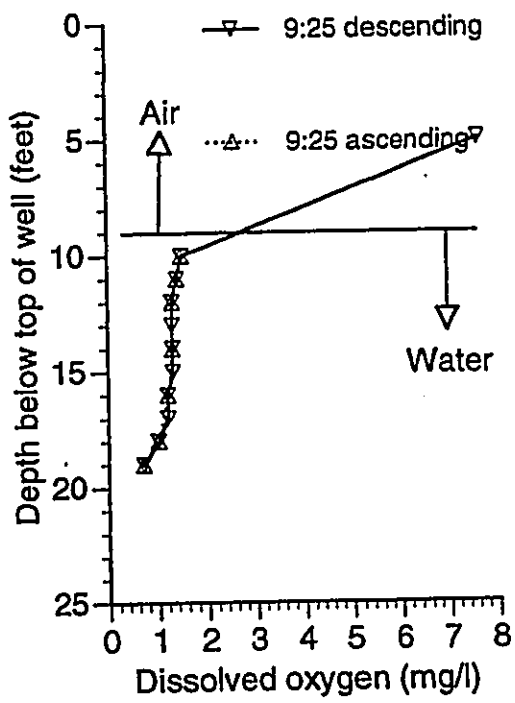

D. Hoover, DG: "O2, T profs 1/11/97"

MW-2: 1/11/97

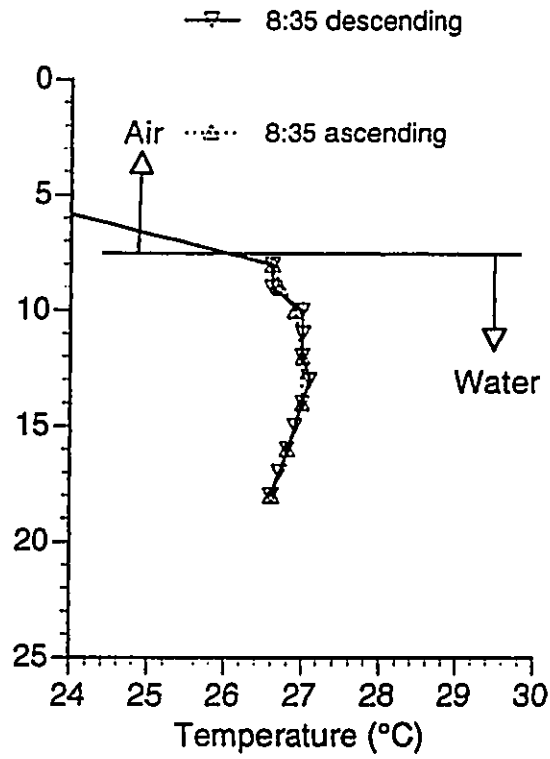
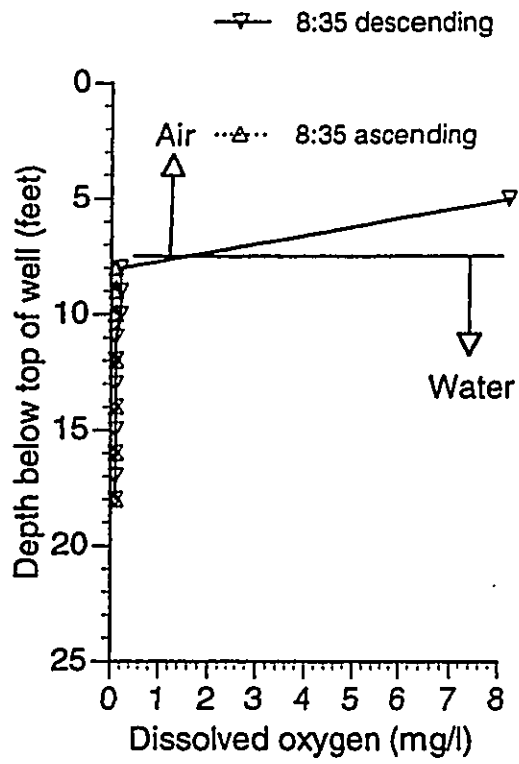

MW-4: 1/11/97

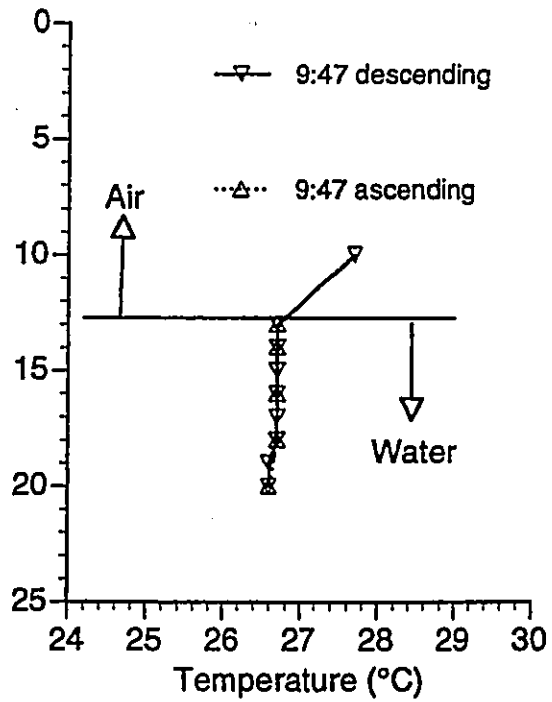
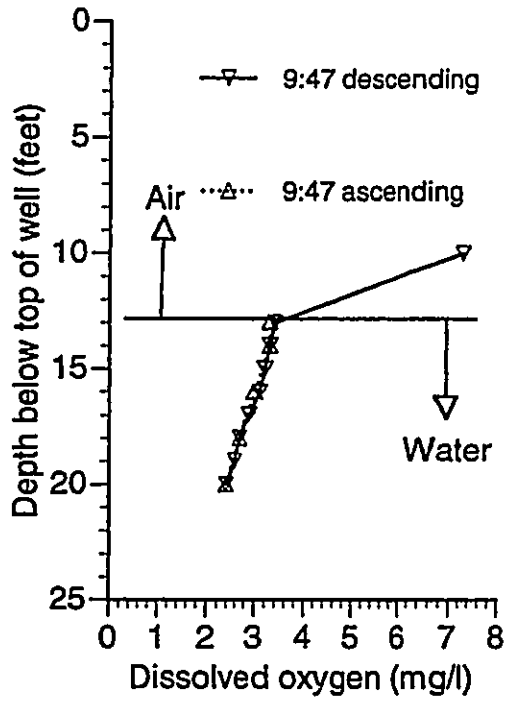

D. Hoover, DG: "O2, T profs 1/11/97"

MW-1: 1/15/97

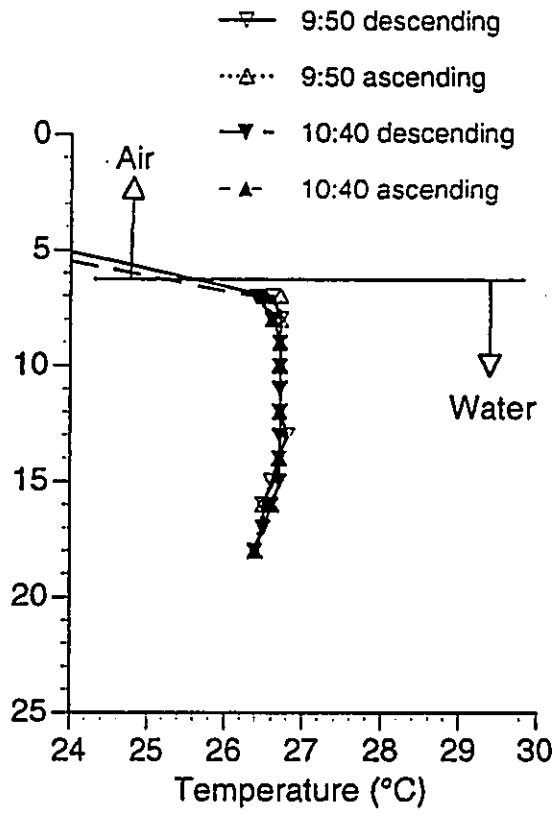
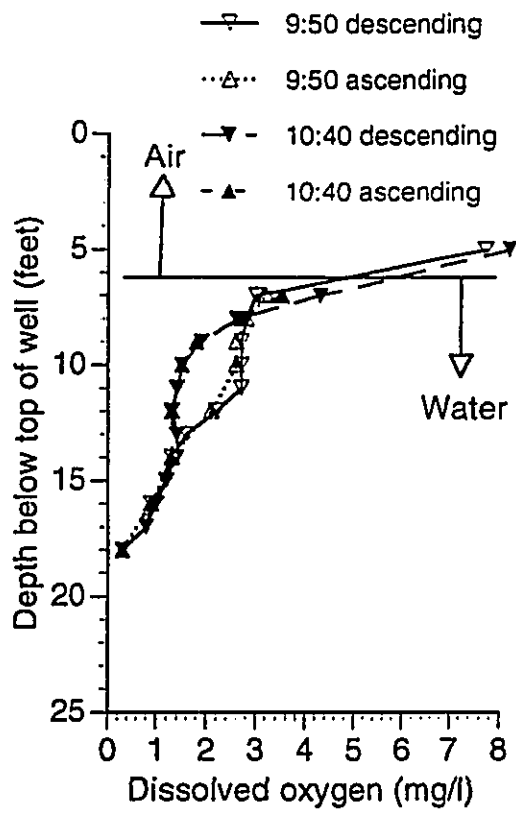

MW-3: 1/15/97

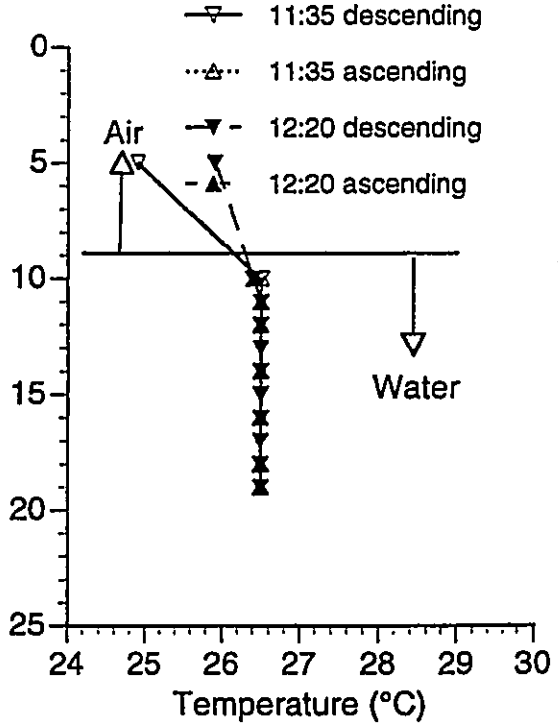
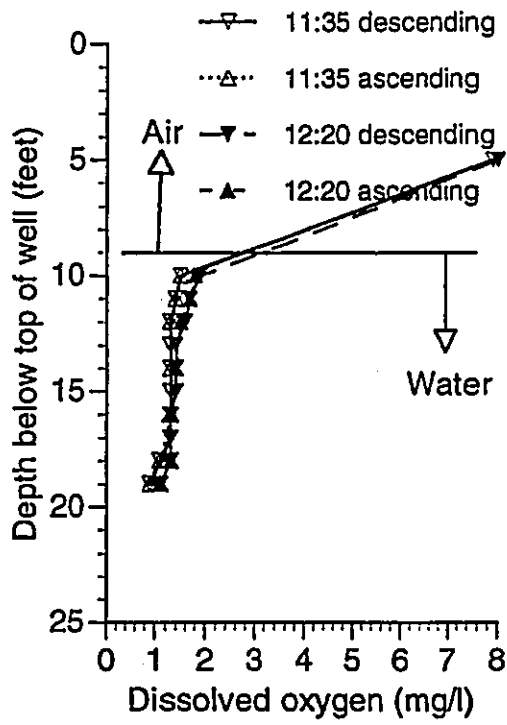

D. Hoover, DG: "O2, T profs 1/15/97"

MW-2: 1/15/97

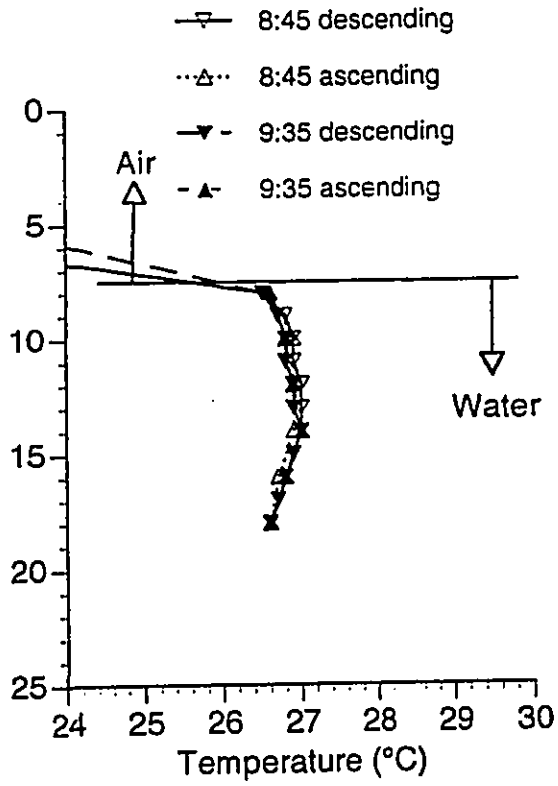
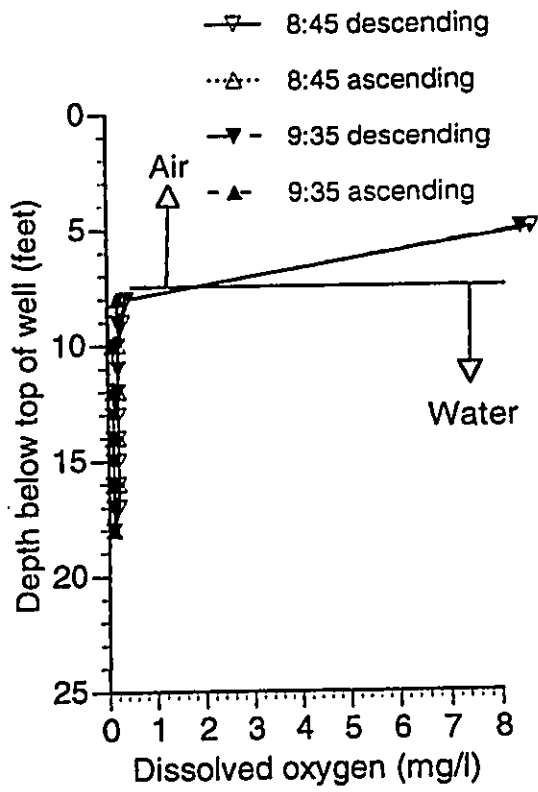

MW-4: 1/15/97

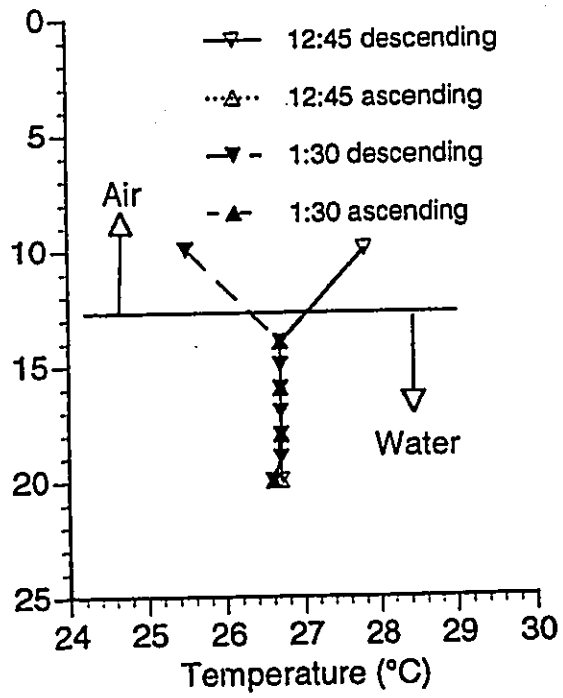
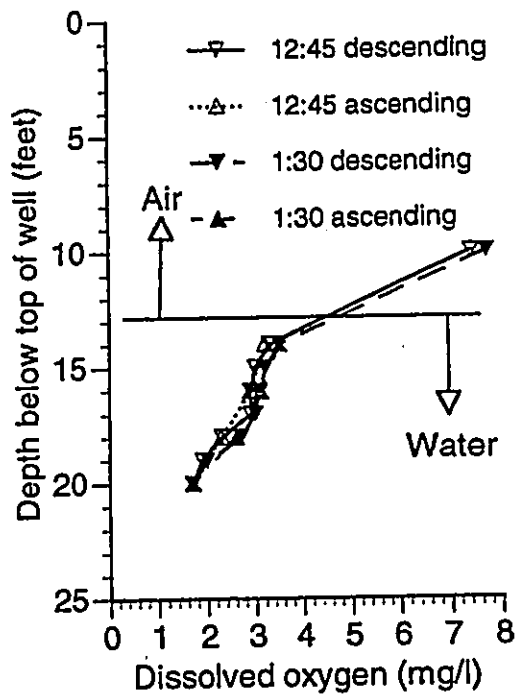

D. Hoover, DG: "O2, T profs 1/15/97"

Appendix B
Nutrient Data

MW-1

Sample ID	Note	Depth	Si (frozen) (µM)	Si (refrig) (µM)	TOC (µM)	NO3 (µM)	NH4 (µM)	DON (µM)	TN (µM)	PO4 (µM)	DOP (µM)	TP (µM)	Salt (‰)
11/6/96													
MW1-1-1		10	253	251	129	821	5.0	24	850	1.25	3.50	4.75	0.670
1-1-2	(1)	10	253	256	125	811	6.0	41	858	1.25	3.25	4.50	0.662
1-2-1		16	244	229	222	7	44.8	9	60	4.25	0.03	4.28	1.266
1-2-2	(1)	16	235	234	224	6	44.5	8	59	4.25	0.10	4.35	1.289
11/21/96													
MW1-1		5	170	201	385	477	10.5	136	624	2.50	5.50	8.00	
1-2		6	192	222	353	620	13.5	94	727	2.00	6.00	8.00	
1-5		9		248									
1-6		10	215		229	1142	10.0	116	1268	1.50	7.00	8.50	
1-9		13	207	250	226	1078	11.5	118	1207	1.50	10.50	12.00	
11/24/96													
MW1B-5		5		208	388	652	7.5	122	781	1.50	11.50	13.00	
1B-6		6	195	221									
1B-10		10		233	289	922	12.0	124	1058	1.50	5.50	7.00	
1B-13		13	213	240									
1B-16		16	214	233	277	872	15.5	102	990	1.50	6.50	8.00	
12/6/96													
MW1-1		6	226		310	865	3.8	163	1032	1.20	2.60	3.80	
1-6		16	206		286	895	3.8	107	1006	1.20	1.80	3.00	
12/18/96													
MW1-1		7	235		230	1090	4.8	94	1189	1.20	1.60	2.80	
1-5		16	229		193	996	4.2	130	1130	1.20	2.00	3.20	
1/2/97													
MW1-1		7	210		190	1113	4.4	122	1239	1.20	2.00	3.20	
1-5		16	251		138	1287	5.6	89	1381	1.40	1.40	2.80	
1/15/97													
MW1-1		7	255		181	1002	7.3	87	1096	1.25	1.75	3.00	
1-5		16	251		153	992	5.0	125	1122	1.50	1.75	3.25	
1-5	(2)	16	250		994	994	7.3			1.50	1.75	3.25	

(1) Sample replicate
(2) Analysis replicate

MW-2

Sample ID	Note	Depth	Si (frozen) (µM)	Si (refrig) (µM)	TOC (µM)	NO3 (µM)	NH4 (µM)	DON (µM)	TN (µM)	PO4 (µM)	DOP (µM)	TP (µM)	Salt (‰)
11/6/96 MW2-1-1		13	264	290	137	2	7.8	13	23	0.95	0.90	1.85	0.564
2-1-2	(1)	13	242	293	132	2	7.1	14	23	0.85	0.85	1.70	0.561
2-2-1	(3)	13	251	297	133	1	12.7	12	26	0.90	0.75	1.65	0.559
2-2-2	(1)(3)	13	255	299	133	1	13.6	14	29	0.90	0.75	1.65	0.560
2-3-1	(4)	13	271	302	143	1	17.1	13	31	0.95	0.75	1.70	0.559
2-3-2	(1)(4)	13	241	305	143	1	17.5	12	31	0.95	0.70	1.65	0.561
2-3-2	(2)(4)	13	241			1	17.8			0.90			
11/21/96 MW2-1		6	141	185	196	42	1.0	20	63	0.80	0.85	1.65	
		7	162	183	181	28	1.1	18	48	0.50	1.00	1.50	
2-5		10	192	192	205	19	38.6	18	76	0.85	1.80	2.65	
2-8		13	251										
		14		217									
12/6/96 MW 2-1		8	165		163	25	14.5	32	71	0.95	0.90	1.85	
2-5		13	310		182	0	104.2	32	137	0.90	1.10	2.00	
12/18/96 MW2-1		8	185		195	28	39.5	39	106	0.95	1.05	2.00	
2-3		13	280		183	0	107.9	46	154	0.90	0.95	1.85	
2-4		16	294		190	0	110.0	45	155	1.20	1.40	2.60	
1/2/97 MW2-1		8	128		121	20	8.2	37	65	0.55	1.05	1.60	
2-4		16	280		183	0	111.9	45	157	1.05	1.25	2.30	
1/15/97 MW 2-1		8	201		296	7	38.6	34	79	0.85	0.70	1.55	
2-4		16	292		191	1	105.6	30	136	1.40	0.70	2.10	

- (1) Sample replicate
- (2) Analysis replicate
- (3) Pumping effect sample - 8 liters pumped between collection of first and second samples
- (4) Pumping effect sample - 8 liters pumped between collection of second and third samples

MW-3

Sample ID	Note	Depth	Si (frozen) (µM)	Si (refrig) (µM)	TOC (µM)	NO3 (µM)	NH4 (µM)	DON (µM)	TN (µM)	PO4 (µM)	DOP (µM)	TP (µM)	Salt (‰)
11/6/96 MW3-1-1		11	316	332	97	217	1.9	10	229	1.10	1.30	2.40	0.581
3-1-2	(1)	11	314	335	88	222	1.6	7	231	1.10	1.30	2.40	0.580
3-2-1		17	321	345	87	233	2.3	16	251	1.00	1.30	2.30	0.592
3-2-2	(1)	17	319	348	88	231	1.5	6	238	0.90	1.30	2.20	0.592
11/21/96 MW3-1		10	236	241	154	343	10.0	98	451	2.00	7.50	9.50	
3-2		11	252	267	150	377	1.5	99	477	1.50	7.50	9.00	
3-2	(2)	11	245			375	1.0			1.50			
3-8		17	278	321	149	450	7.0	95	552	1.50	6.50	8.00	
12/6/96 MW3-1		10	284		113	356	2.7	64	423	0.80	1.00	1.80	
3-5		17	299		101	430	1.4	59	491	0.90	1.20	2.10	
12/18/96 MW3-1		10	309		103	379	1.1	51	431	0.90	1.00	1.90	
3-4		16	320		93	405	1.8	63	469	1.00	0.70	1.70	
1/2/97 MW3-1		10	290		98	269	1.3	57	327	0.90	0.70	1.60	
3-4		16	298		95	295	1.8	42	339	0.90	0.40	1.30	
1/15/97 MW3-1		10	249		98	199	2.5	43	244	0.80	0.40	1.20	
3-4		16	258		97	209	2.8	35	247	0.80	0.60	1.40	

(1) Sample replicate
(2) Analysis replicate

MW-4

Sample ID	Note	Depth	Si (frozen) (µM)	Si (refrig) (µM)	TOC (µM)	NO3 (µM)	NH4 (µM)	DON (µM)	TN (µM)	PO4 (µM)	DOP (µM)	TP (µM)	Salt (%)
11/6/96													
MW4-1-1		16	419	440	85	1073	4.3	44	1121	1.00	4.50	5.50	0.623
4-1-2	(1)	16	440	444	82	1121	5.3	47	1173	1.50	6.50	8.00	0.618
4-1-2	(2)	16	442			1126	5.8			1.75			
11/21/96													
MW4-1		14	358	399	122	2469	15.5	143	2627	2.50	5.00	7.50	
4-2		15	395	461	113	2736	13.0	158	2907	1.50	6.50	8.00	
4-2	(2)	15	393			2753	11.5			1.50			
4-3		16	414		112	2365	10.0	147	2522	1.50	6.50	8.00	
4-5		18	432	511	92	1842	10.3	174	2026	1.00	2.75	3.75	
12/6/96													
MW4-1		14	462		99	2995	6.0	105	3106	3.00	0.25	3.25	
4-5		18	512		89	3151	4.0	169	3324	1.00	2.50	3.50	
12/18/96													
MW4-1		14	505		93	2763	5.3	101	2869	1.00	1.75	2.75	
4-4		18	504		89	2785	8.5	116	2910	1.00	3.50	4.50	
1/2/97													
MW4-1		14	439		92	2057	6.3	156	2220	1.00	2.75	3.75	
4-4		18	460		114	2127	7.3	125	2259	1.00	3.75	4.75	
4-4	(2)	18	461			2125	6.3	129	2261	1.50	2.75	4.25	
1/15/97													
MW4-1		14	347		89	1335	8.8	59	1403	1.25	1.00	2.25	
4-4		18	389		88	1545	8.0	63	1616	1.00	1.50	2.50	

(1) Sample replicate
(2) Analysis replicate

Municipal Water Supply

Sample ID	Note	Depth	Si (frozen) (µM)	Si (refrig) (µM)	TOC (µM)	NO3 (µM)	NH4 (µM)	DON (µM)	TN (µM)	PO4 (µM)	DOP (µM)	TP (µM)	Salt (%)
1/15/97													
MCD-1			500		24	13	0.1	3	17	1.06	0.14	1.20	